

Short-stroke cylinder, Series SSI, Double-acting, with magnetic piston

2024-09-13

R481653579

The AVENTICS Series SSI are short stroke cylinders in accordance with the latest ISO standard 15524. The cylinders are compact and up to 30% lighter than comparable cylinders thanks to weight optimized profiles. In addition, they provide a high degree of flexibility in sensor assembly and extremely effective elastic cushioning.



Technical data

Industry	Industrial
Standards	ISO 15524
Piston Ø	100 mm
Stroke	80 mm
Ports	3/8" NPTF
Functional principle	Double-acting
Cushioning	Elastic cushioning
Magnetic piston	Piston with magnet
Environmental requirements	Industry standard
Piston rod thread - type	Piston rod: internal thread
Piston rod thread	3/4-16 UNF
Piston rod	single
Scraper	Standard Industry Scraper
Pressure for determining piston forces	6,3 bar
Retracting piston force	4441 N
Extracting piston force	4948 N
Min. ambient temperature	-20 °C
Max. ambient temperature	80 °C
Min. working pressure	0.6 bar

Short-stroke cylinder, Series SSI, Double-acting, with magnetic piston

2024-09-13

R481653579

Max. working pressure	10 bar
Impact energy	0.5 J
Weight 0 mm stroke	1.89 kg
Weight +10 mm stroke	0.168 kg
Stroke max.	150 mm
Medium	Compressed air
Min. medium temperature	-20 °C
Max. medium temperature	80 °C
Max. particle size	50 µm
Min. oil content of compressed air	0 mg/m ³
Max. oil content of compressed air	5 mg/m ³

Material

Piston rod	Stainless Steel
Scraper material	Polyurethane
Seal material	Polyurethane
Material, front cover	Aluminum
Cylinder tube	Aluminum
End cover	Aluminum
Part No.	R481653579

Technical information

Use our Internet configurator to order variants with an external thread.

The pressure dew point must be at least 15 °C less than ambient and medium temperature and may not exceed 3 °C.

The oil content of compressed air must remain constant during the life cycle.

Use only the approved oils from AVENTICS. Further information can be found in the "Technical information" document (available in <https://www.emerson.com/en-us/support>).

Short-stroke cylinder, Series SSI, Double-acting, with magnetic piston

2024-09-13

R481653579
Dimensions

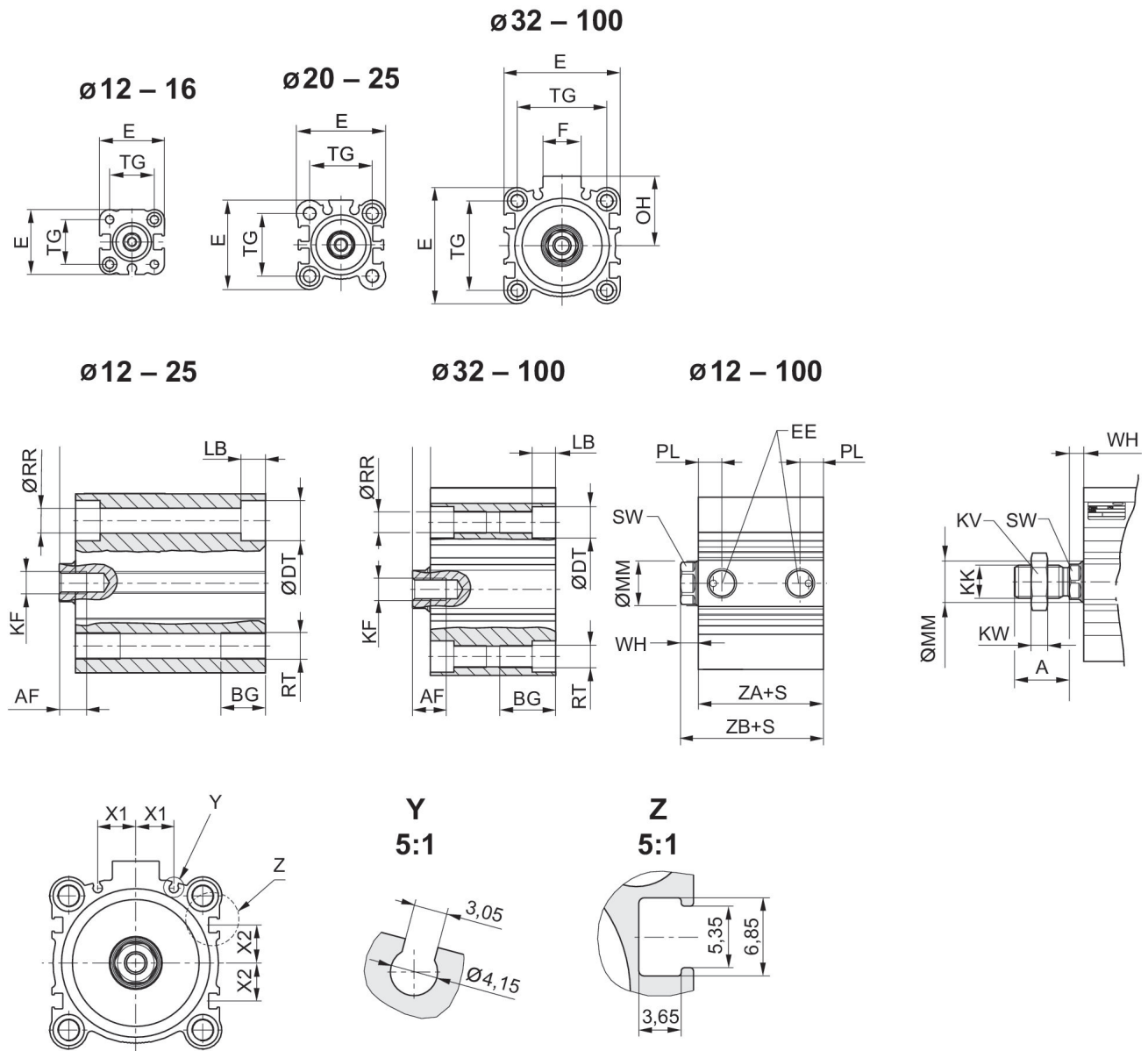

S = stroke

Piston Ø	A ±0.3	AF	BG	ØDT	E	EE	F	KF	KK
12	10,5	6	7	6,5	25	10-32 UNF	-	6-32 UNC	8-32 UNC
16	12	8	7	6,5	29	10-32 UNF	-	8-32 UNC	8-32 UNC
20	14	7	10	9	36	10-32 UNF	-	10-32 UNF	10-32 UNC
25	17,5	12	10	9	40	10-32 UNF	-	1/4-28 UNF	1/4-28 UNF
32	21,5	13	16	9	45	1/8" NPTF	17	5/16-24 UNF	5/16-24 UNF
40	21,5	13	16	9	52	1/8" NPTF	17	3/8-24 UNF	3/8-24 UNF
50	26,5	15	20	11	64	1/4" NPTF	21	1/2-20 UNF	1/2-20 UNF
63	26,5	15	25	14	77	1/4" NPTF	21	1/2-20 UNF	1/2-20 UNF

Short-stroke cylinder, Series SSI, Double-acting, with magnetic piston

2024-09-13

R481653579

Piston Ø	A ±0.3	AF	BG	ØDT	E	EE	F	KF	KK
80	34	21	30	17,5	98	3/8" NPTF	26	5/8-18 UNF	5/8-18 UNF
100	33	27	30	17,5	117	3/8" NPTF	26	3/4-16 UNF	3/4-16 UNF

Piston Ø	KV	KW	LB max.	ØMM f8	OH	ØRR	RT	SW	TG
12	8,7	2,8	3,5	6	-	3,7	8-32 UNC	5	15,5 ±0,3
16	8,7	2,8	3,5	8	-	3,7	8-32 UNC	7	20 ±0,3
20	9,5	2,8	5,5	10	-	5,55	1/4-20 UNC	8	25,5 ±0,3
25	11,1	4,1	5,5	12	-	5,55	1/4-20 UNC	10	28 ±0,3
32	12,7	4,9	5,5	16	27	5,55	1/4-20 UNC	13	34 ±0,3
40	14,2	5,7	5,5	16	31	5,55	1/4-20 UNC	13	40 ±0,3
50	19	8,2	8	20	39	7,4	5/16-24 UNF	17	50 ±0,5
63	19	8,2	10,5	20	45,5	9,3	7/16-14 UNC	17	60 ±0,5
80	23,9	9,8	13,5	25	59	11,2	1/2-13 UNC	22	77 ±0,5
100	28,4	11,3	13,5	32	65	11,2	1/2-13 UNC	27	94 ±0,5

Piston Ø	WH 3)	WH 4)	X1	X2	S	PL	ZA±0,2	ZB±2 1)	ZB±2 2)
12	3,5 ±1,5	3,5 ±1,5	0	0	≥2	5,5	28	31,5	31,5
16	3,5 ±1,5	3,5 ±1,5	0	0	≥2	5,5	30,5	34	34
20	4,5 ±1,5	4,5 ±1,5	5,7	4,275	≥2	5,5	31,5	36	36
25	5 ±1,5	5 ±1,5	6	5	≥2	5,5	32,5	37,5	37,5
32	7 ±2	7 ±2	8,5	7,5	≥2	7,9	33	40	40
40	7 ±2	7 ±2	10,75	11	≥2	8,2	39,5	46,5	46,5
50	8 ±2	7 ±2	14	13	≥2	10,5	40,5	48,5	47,5
63	8 ±2	7 ±2	17	17	≥2	10,6	46	54	53
80	10 ±2	9,5 ±2	23,5	21	≥2	12,5	53,5	63,5	63
100	12 ±2,5	10,5 ±2,5	31	28	≥2	14	63	75	73,5

1) Internal thread

Maximum admissible lateral force
Ø 32 ... 100 mm



X = distance between force application point and cylinder cover
FS = lateral force
S = stroke

2) External thread

Maximum admissible lateral force
Ø 12 ... 25 mm

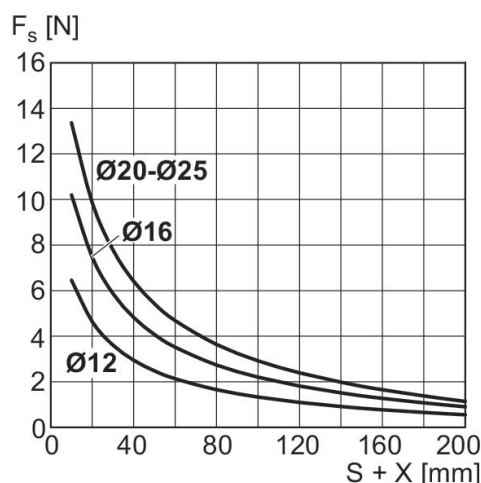

X = distance between force application point and cylinder cover
FS = lateral force
S = stroke

Short-stroke cylinder, Series SSI, Double-acting, with magnetic piston

2024-09-13

R481653579

Maximum admissible lateral force

Ø 12 ... 25 mm



X = distance between force application point and cylinder cover

F_s = lateral force

S = stroke

Short-stroke cylinder, Series SSI, Double-acting, with magnetic piston

2024-09-13

R481653579
Overview drawing



Use our Internet configurator to order variants with an external thread.

NOTE: This overview drawing is only for orientation to indicate where the various accessory parts can be fastened to the cylinder. The illustration has been simplified for this purpose. It is thus not possible to derive the dimensions from this overview.