

The AVENTICS Series RCM with its rotary modules can perform all standardized rotary and swivel movements. These modules can be installed directly on mini slides and are equipped with mechanical grippers.

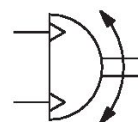

Technical data

Industry	Industrial
Diameter	12 mm
Compressed air connection	M5
Magnetic piston	with magnetic piston
Rotary compact module version	Double piston with rack
Easy2Combine	capable
Frame size	RCM-12
Theoretical torque at	6 bar
Min. swivel times	0.1 s
Air consumption per rotation	5.86 cm ³
Max. permissible axial bearing load	330 N
Radial shaft load	360 N
Max. permissible mass moment of inertia	0.7
Theoretical torque	0.95 Nm
Repetitive precision	0.2 °
Cushioning	elastic
Min. angle of rotation	0 °
Max. angle of rotation	90 °
Min. working pressure	2 bar

Max. working pressure	8 bar
Min. ambient temperature	5 °C
Max. ambient temperature	60 °C
Min. medium temperature	5 °C
Max. medium temperature	60 °C
Medium	Compressed air
Min. oil content of compressed air	0 mg/m ³
Max. oil content of compressed air	1 mg/m ³
Max. particle size	5 µm
Weight	0.42 kg

Material

Housing material	Aluminum
Surface housing	anodized
Material front cover	Aluminum
Surface cover	black anodized
Material base	Aluminum
Surface base	black anodized
Seal material	Acrylonitrile butadiene rubber
Material axis	Steel, chrome-plated
Surface axis	hardened
Material rotary flange	Steel, chrome-plated
Surface rotary flange	hardened
Part No.	R412000361

Technical information

The pressure dew point must be at least 15 °C less than ambient and medium temperature and may not exceed 3 °C.

The oil content of compressed air must remain constant during the life cycle.

Use only the approved oils from AVENTICS. Further information can be found in the “Technical information” document (available in <https://www.emerson.com/en-us/support>).

Rotary Compact Module, Series RCM-SE

2024-04-05

R412000361

RCM-6/.../-25

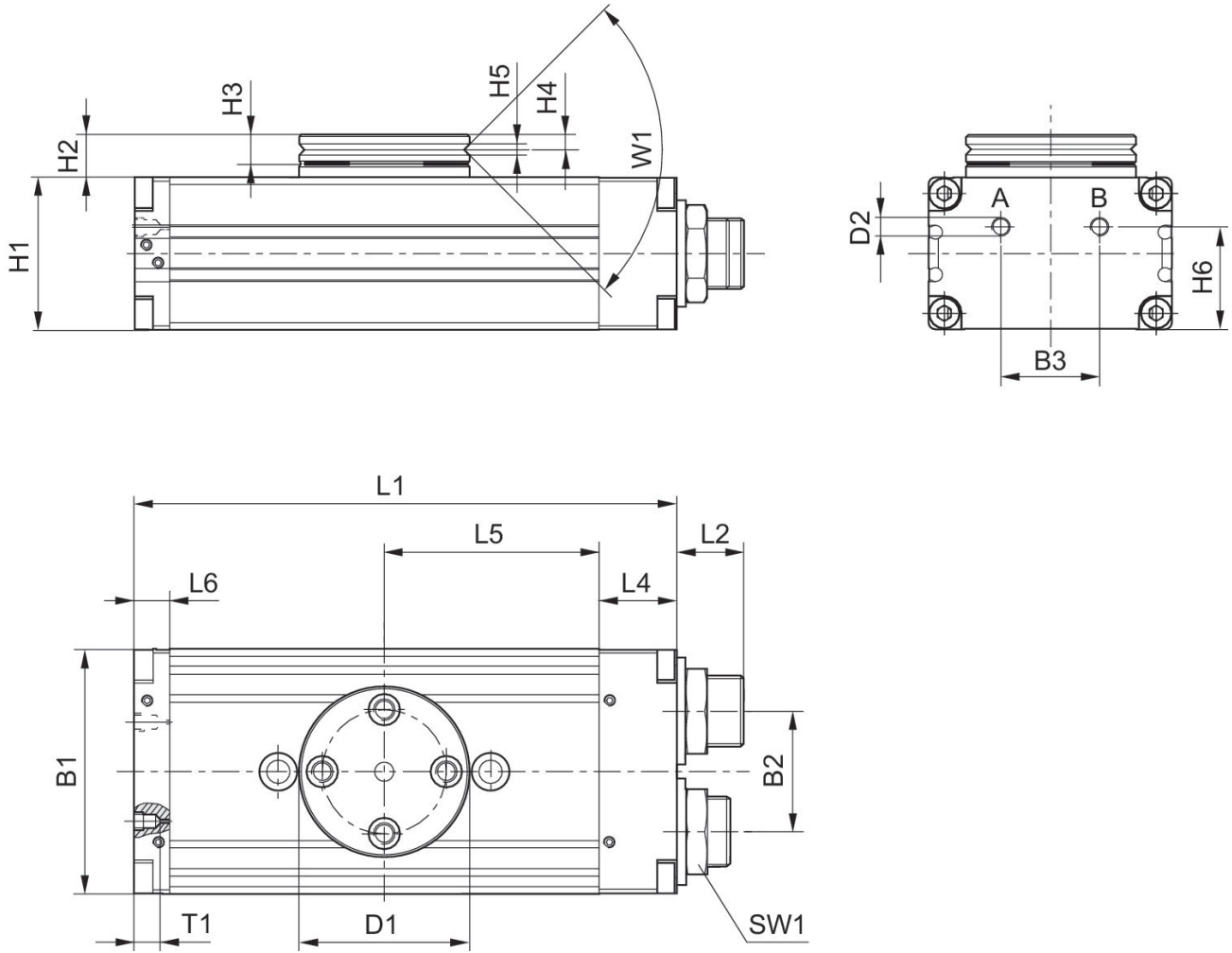

T1 = depth of thread

Frame size	Part No.	B1	B2	B3	Ø D1	Ø D2	H1	H2	H3
RCM-06	R412000357	31	13.6	11.6	26	M3	17	7.5	5
RCM-06	R412000358	31	13.6	11.6	26	M3	17	7.5	5
RCM-08	R412000359	35	15	13	28	M3	18	8	5
RCM-08	R412000360	35	15	13	28	M3	18	8	5
RCM-12	R412000361	43	18	18	35	M5	24	10.5	6
RCM-12	R412000362	43	18	18	35	M5	24	10.5	6

Frame size	H4	H5	H6	L1	L2	L4	L5	L6	SW1
RCM-06	2.4	2	12.9	71	9	7	28.5	7	8
RCM-06	2.4	2	12.9	71	9	7	28.5	7	8
RCM-08	2.4	2	14	77	9.5	7	31.5	7	10
RCM-08	2.4	2	14	77	9.5	7	31.5	7	10
RCM-12	2.9	2.5	18	103	12.5	14	40	9	15
RCM-12	2.9	2.5	18	103	12.5	14	40	9	15

Frame size	T1	W1
RCM-06	3	90°
RCM-06	3	90°
RCM-08	3	90°
RCM-08	3	90°
RCM-12	4	90°
RCM-12	4	90°

Mounting and assembly RCM-12

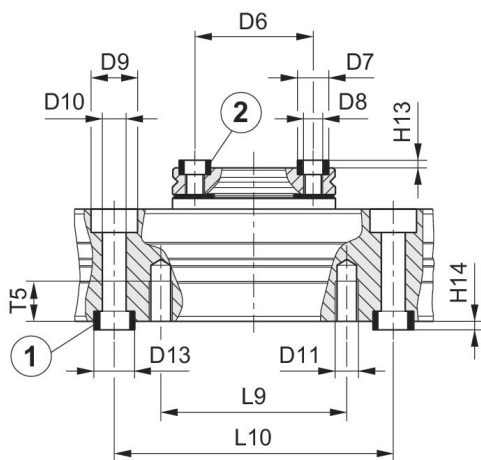

1) centering sleeve, included in the scope of delivery 2) centering sleeve

Maximum permissible radial force F_y [N] as a function of v [mm]

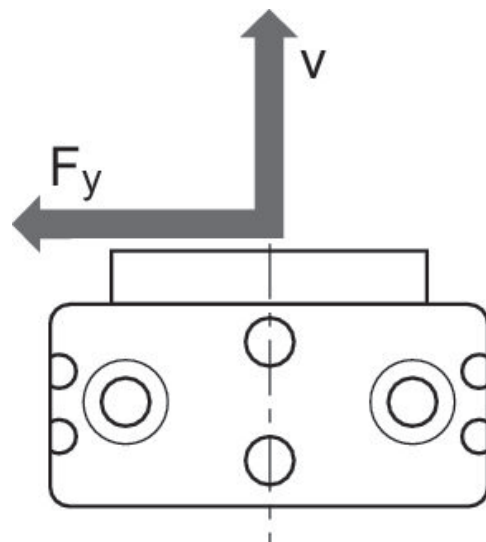

Maximum permissible axial force F_x [N] as a function of u [mm]

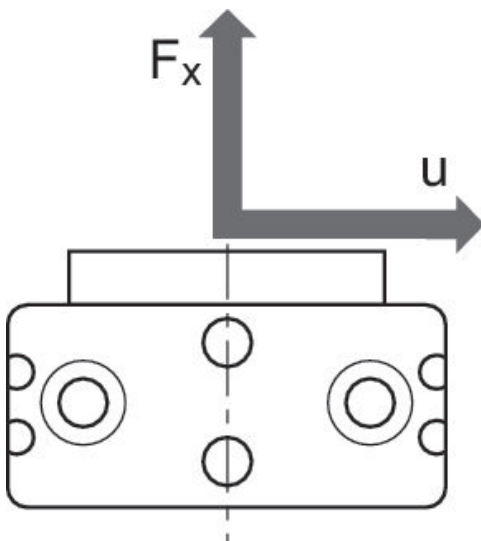

Setting range for end positions 0° / 90° / 180°

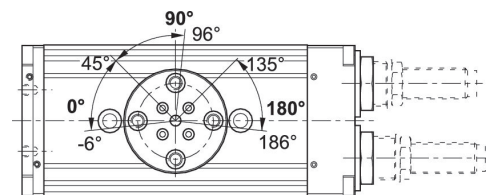

Movement into end position 90°/180°

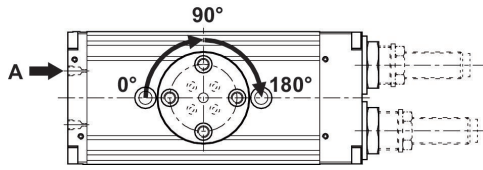

Movement into end position 0°

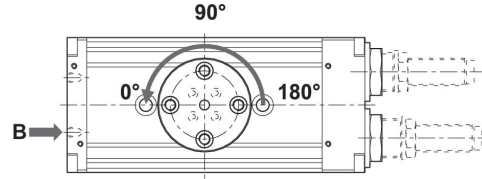

Maximum permissible radial force F_y [N] as a function of v [mm]
RCM 12

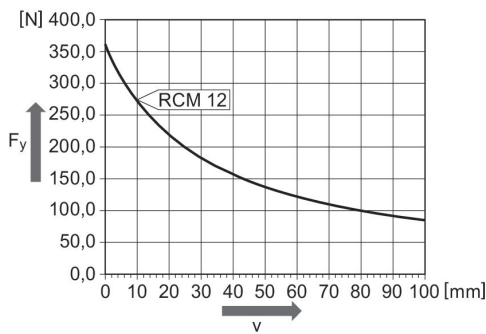

Maximum permissible axial force F_x [N] as a function of u [mm]
RCM 6 – 12

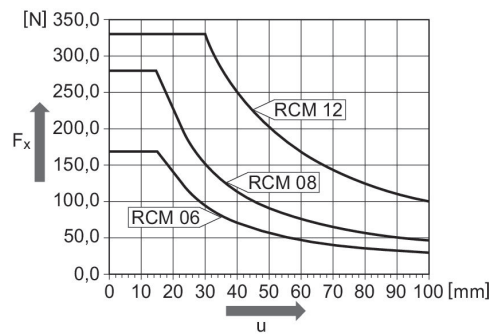

Maximum permissible radial force F_y [N] as a function of v [mm]
RCM 6 – 12

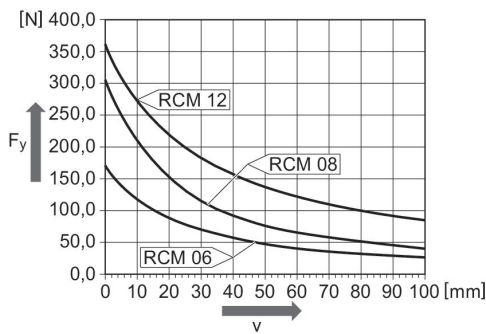

Frame size	Part No.	Ø D6 ±0,02	Ø D7 k6	Ø D8	Ø D9	Ø D10	Ø D11	Ø D12	Ø D13 k6
RCM-06	R412000357	18	5	M3	6	3.3	M4	–	5
RCM-06	R412000358	18	5	M3	6	3.3	M4	–	5
RCM-08	R412000359	20	5	M3	7.5	4.2	–	M5	7
RCM-08	R412000360	20	5	M3	7.5	4.2	–	M5	7
RCM-12	R412000361	25	7	M4	10	5.1	M5	–	9
RCM-12	R412000362	25	7	M4	10	5.1	M5	–	9

Rotary Compact Module, Series RCM-SE

2024-04-05

R412000361

Frame size	H13 +0,2	H14 +0,2	L9	L10 ± 0,02	T5	T6
RCM-06	1.6	1.6	20	40	7	–
RCM-06	1.6	1.6	20	40	7	–
RCM-08	1.6	1.6	–	40	–	9.1
RCM-08	1.6	1.6	–	40	–	9.1
RCM-12	1.6	2.1	40	60	8.5	–
RCM-12	1.6	2.1	40	60	8.5	–