

Pressure regulator, Series 651

G651AR001GA00H0

General series information Series 651

- The AVENTICS Series 651 is an easy-to-install line of pneumatic filters, regulators and lubricators (FRLs) that offer the industry's highest flow rates and widest temperature ratings. Available in 1/8-inch, and 1/4-inch port sizes, these FRLs are ideal for automotive and tire, packaging, food and beverage, and process applications requiring highly reliable operation and robust, modern-looking equipment.

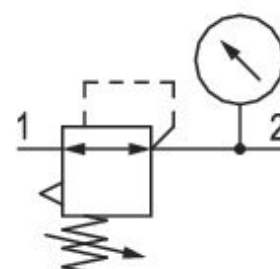

Technical data

Industry	Industrial
Parts	Pressure regulator
Port	G 1/8
Compressed air connection standard	according to ISO 228-1
Nominal flow Qn	800 l/min
Regulation range min.	0.5 bar
Regulation range max.	10 bar
Working pressure min.	0 bar
Working pressure max	16 bar
Min. ambient temperature	-20 °C
Max. ambient temperature	50 °C
Ambient temperature note	Extended temperature range min./max. (optional) -40 °C ... 80 °C

Regulator type	Can be assembled into blocks
Certificates	ATEX optional
Hysteresis	0,3 bar
Medium	Compressed air Neutral gases
Weight	0.22 kg

Material

Housing material	Aluminum
Material front plate	Polyamide
Seal material	Nitrile butadiene rubber
Part No.	G651AR001GA00H0

Technical information

The pressure dew point must be at least 15 °C less than ambient and medium temperature and may not exceed 3 °C.

The oil content of compressed air must remain constant during the life cycle.

Use only the approved oils from AVENTICS. Further information can be found in the "Technical information" document (available in <https://www.emerson.com/en-us/support>).

Dimensions

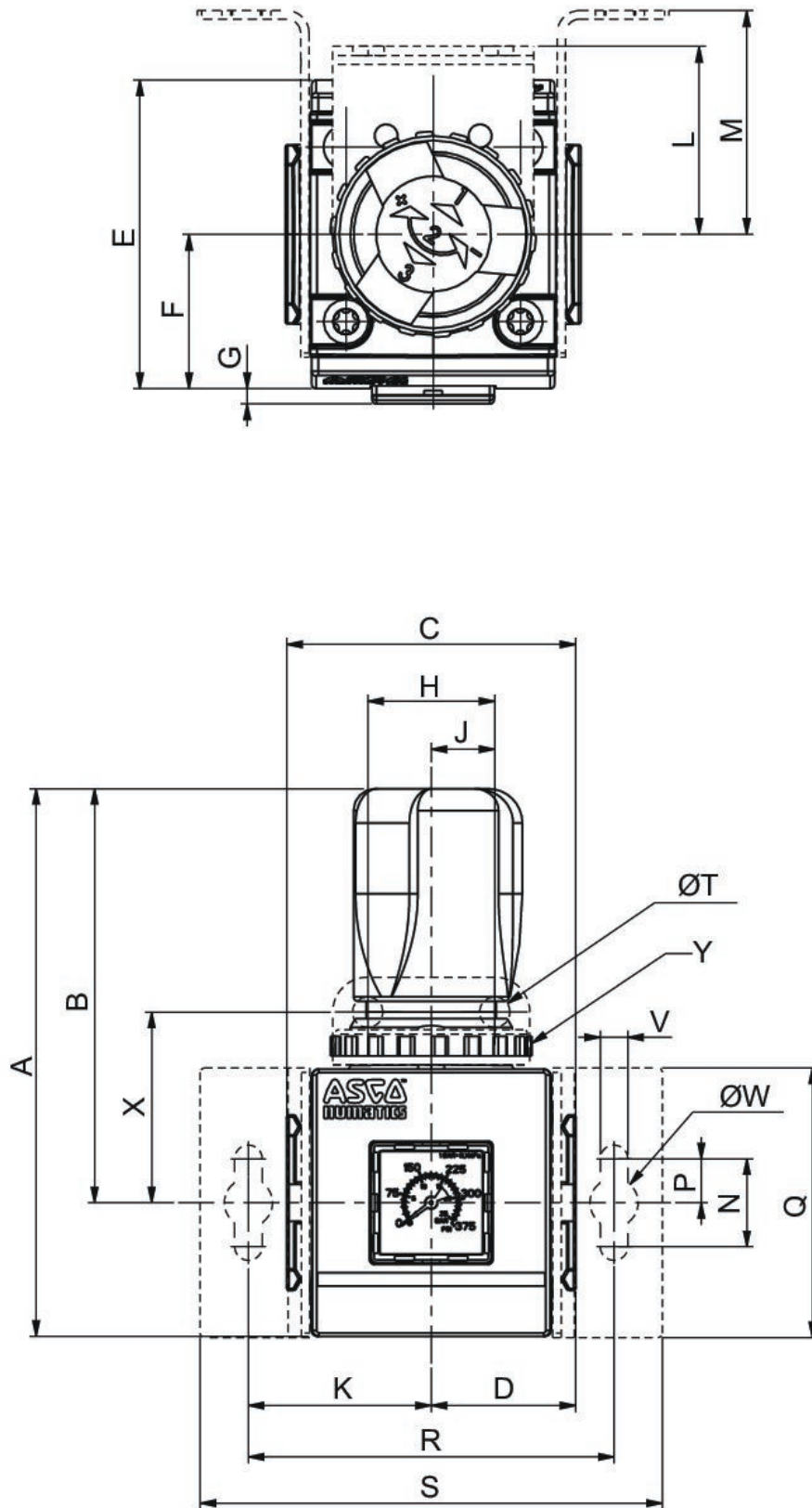

Series	651
A	103
B	77.5
C	50
D	25
E	58
F	29
G	3,4
H	29
J	14,5
K	35
L	42
M	44,5
N	20
P	10
Q	50
R	70
S	92
T	7
V	6,3
W	11
X	39,1
Y	M30x2

Flow diagram
G 1/4

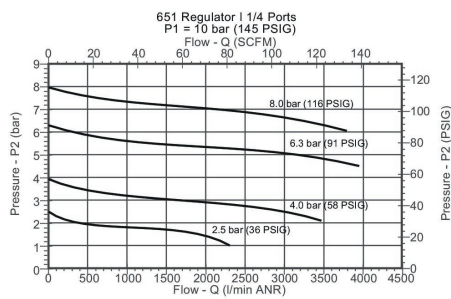

Flow diagram
G 1/8

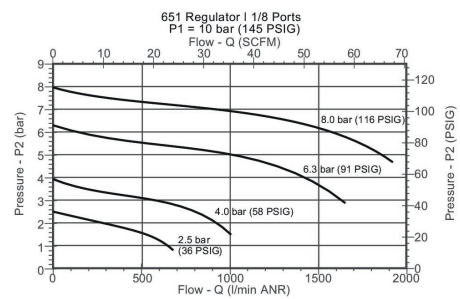

Accessories overview

