

5/3-directional valve, Series Rotair®

R432013836

Series 563 018, 563 131

■ Qn max. [[1100] l/min]

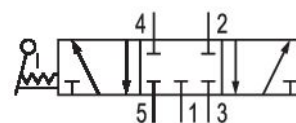

Technical data

Industry
Industrial

Activation
Mechanical

Nominal flow Qn
1082.4 l/min

Compressed air connection output
1/8 NPT

Sealing principle
Soft Seal

Type
Poppet valve

Min. ambient temperature
-25 °C

Max. ambient temperature
10 °C

Min. medium temperature
-25 °C

Max. medium temperature
10 °C

Medium
Compressed air

Compressed air connection input
1/8 NPT

Compressed air connection, exhaust
1/8 NPT

Weight
0.73 kg

Housing material
Die cast zinc

Seal material
Buna-N

Part No.
R432013836

Technical information

The min. control pressure must be adhered to, since otherwise faulty switching and valve failure may result!

The pressure dew point must be at least 15 °C under ambient and medium temperature and may not exceed 3 °C .

The oil content of compressed air must remain constant during the life cycle.

Use only the approved oils from AVENTICS. Further information can be found in the “Technical information” document (available in <https://www.emerson.com/en-us/support>).

Dimensions in inches

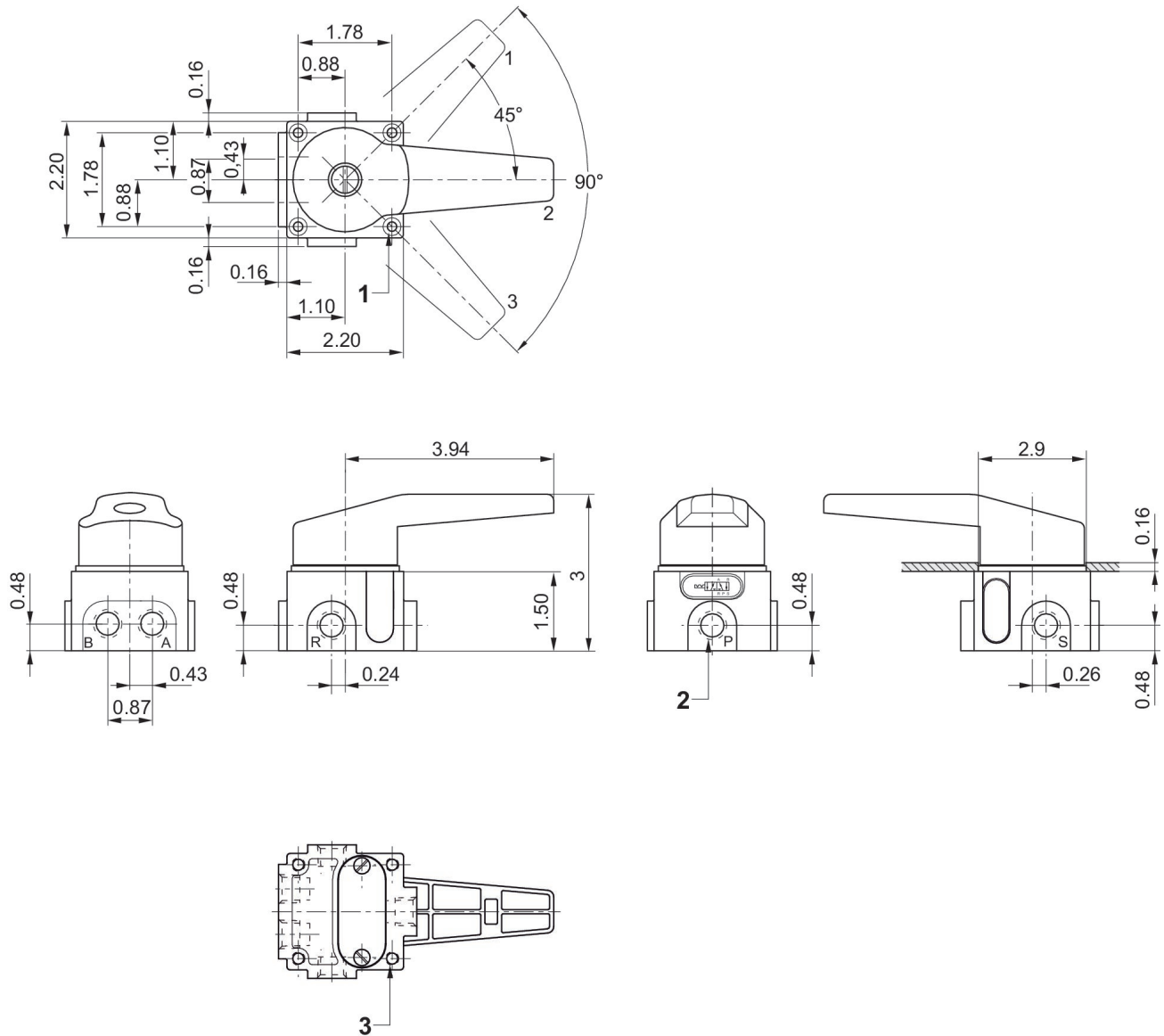

- 1) .31" external diameter X (.145" deep) .18" internal thread X (1.35 deep) = 1.5" through
- 2) Connections [1 ,3 ,5, 2, 4]
- 3) 1/4" - 20 UNC-2B X .38" deep