

Round cylinder, Series RPC

R412020745

AVENTICS
Series RPC
Round
cylinders

2024-04-05

AVENTICS Series RPC Round cylinders

The AVENTICS Series RPC round profile cylinders offer a wide variety of connection options. They are easy to clean and suitable for packaging applications in the food industry due to food grade lubricants. The Series RPC can also be used in standard applications across machine automation needs.

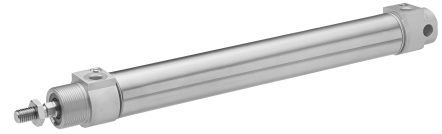

Technical data

| | |
|--|------------------------------------|
| Industry | Industrial |
| Type | Version: standard type |
| Piston Ø | 40 mm |
| Stroke | 200 mm |
| Ports | G 1/4 |
| Functional principle | Double-acting |
| Cushioning | Pneumatic adjustable cushioning |
| Magnetic piston | Piston with magnet |
| Environmental requirements | Industry standard ATEX optional |
| Piston rod thread - type | External thread |
| Piston rod thread | M12x1,25 |
| Piston rod | single |
| Scraper | Standard Industry Scraper |
| Pressure for determining piston forces | 6,3 bar |
| Retracting piston force | 660 N |
| Extracting piston force | 790 N |
| Min. ambient temperature | -20 °C |
| Max. ambient temperature | 80 °C |
| Min. working pressure | 1 bar |
| Max. working pressure | 10 bar |
| Cushioning length | 19 mm |
| Cushioning energy | 9 J |
| Weight 0 mm stroke | 0.58 kg |

Round cylinder, Series RPC

R412020745

AVENTICS
Series RPC
Round
cylinders

2024-04-05

| | |
|--|--|
| Weight +10 mm stroke | 0.024 kg |
| Stroke max. | 1200 mm |
| Medium | Compressed air |
| Min. medium temperature | -20 °C |
| Max. medium temperature | 80 °C |
| Max. particle size | 50 µm |
| Min. oil content of compressed air | 0 mg/m ³ |
| Max. oil content of compressed air | 5 mg/m ³ |
| Clamping piece for magnetic field sensor necessary | Clamping piece for magnetic field sensor necessary |

Material

| | |
|-----------------------|----------------------|
| Piston rod | Stainless Steel |
| Scraper material | Polyurethane |
| Seal material | Polyurethane |
| Material, front cover | Aluminum |
| Cylinder tube | Stainless Steel |
| End cover | Aluminum |
| Nut for piston rod | Steel, chrome-plated |
| Part No. | R412020745 |

Technical information

Use our Internet configurator to order these variants with coarse-pitch thread M10x1.5 or M12x1.75. ATEX-certified cylinders with identification II 2G Ex h IIC T4 Gb / II 2D Ex h IIC T135°C Db_X can be generated in the Internet configurator.

The operating temperature range for ATEX-certified cylinders is -20°C ... 60°C.

The pressure dew point must be at least 15 °C less than ambient and medium temperature and may not exceed 3 °C.

The oil content of compressed air must remain constant during the life cycle.

Use only the approved oils from AVENTICS. Further information can be found in the "Technical information" document (available in <https://www.emerson.com/en-us/support>).

Round cylinder, Series RPC

R412020745

AVENTICS
Series RPC
Round
cylinders

2024-04-05

Dimensions

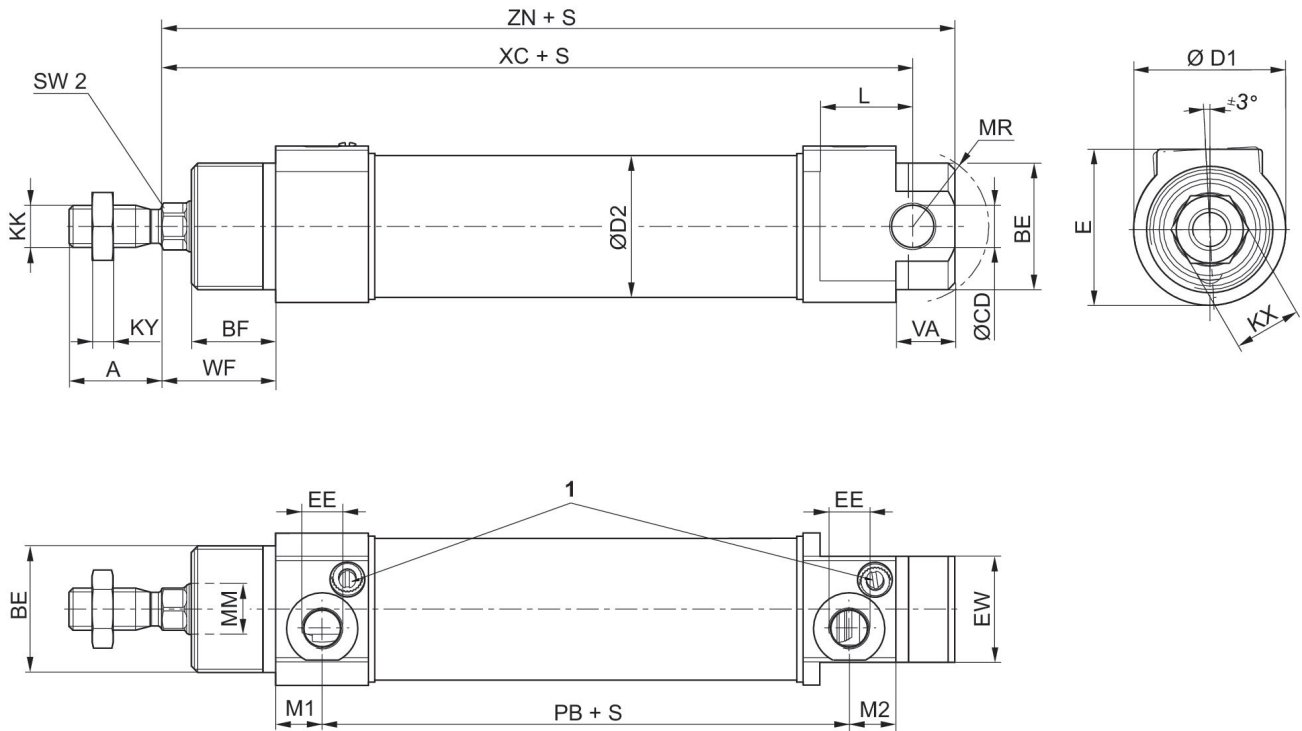

S=stroke

1) Slot in throttle screw 1 mm

| Piston \varnothing | A | BE | BF | $\varnothing CD$ H8 | $\varnothing D1$ | $\varnothing D2$ | E | EE | EW |
|----------------------|----|---------|------|---------------------|------------------|------------------|----|-------|----|
| 32 | 22 | M30x1,5 | 20 | 10 | 36 | 33.5 | 37 | G 1/8 | 25 |
| 40 | 24 | M38x1,5 | 23 | 12 | 45 | 41.5 | 45 | G 1/4 | 30 |
| 50 | 32 | M45x1,5 | 24 | 12 | 55 | 52.5 | 55 | G 1/4 | 35 |
| 63 | 32 | M45x1,5 | 26.5 | 16 | 69 | 65.4 | 69 | G 3/8 | 35 |

| Piston \varnothing | KK | KX | KY | L min. | \varnothing MM f8 | M1 | M2 | MR | PB |
|----------------------|-----------|----|----|--------|---------------------|------|------|------|------|
| 32 | M10x1,25* | 16 | 5 | 22 | 12 | 11 | 11 | 18 | 75 |
| 40 | M12x1,25* | 19 | 6 | 23 | 16 | 11.5 | 11.5 | 22.5 | 87 |
| 50 | M16x1,5 | 24 | 8 | 26 | 20 | 11.5 | 11.5 | 25.5 | 87.5 |
| 63 | M16x1,5 | 24 | 8 | 29 | 20 | 13 | 13.5 | 36.5 | 92 |

| Piston \varnothing | SW2 | VA | WF | XC | ZN |
|----------------------|-----|----|------|-----|-----|
| 32 | 10 | 14 | 27 | 128 | 138 |
| 40 | 13 | 15 | 32 | 146 | 157 |
| 50 | 17 | 18 | 33.5 | 151 | 162 |
| 63 | 17 | 20 | 36.5 | 161 | 175 |

Round cylinder, Series RPC

R412020745

AVENTICS
Series RPC
Round
cylinders

2024-04-05

Overview drawing



NOTE: This overview drawing is only for orientation to indicate where the various accessory parts can be fastened to the cylinder. The illustration has been simplified for this purpose. It is thus not possible to derive the dimensions from this overview.