

## Series RPC

The AVENTICS Series RPC round profile cylinders offer a wide variety of connection options. They are easy to clean and suitable for packaging applications in the food industry due to food grade lubricants. The Series RPC can also be used in standard applications across machine automation needs.

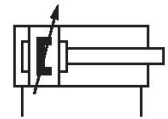
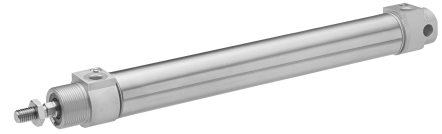

## Technical data

Industry	Industrial
Type	Version: Standard type, heat-resistant
Piston Ø	50 mm
Stroke	100 mm
Ports	G 1/4
Functional principle	Double-acting
Cushioning	Pneumatic adjustable cushioning
Magnetic piston	Piston with magnet
Environmental requirements	Industry standard Heat resistant
Piston rod thread - type	External thread
Piston rod thread	M16x1,5
Piston rod	single
Scraper	Heat-Resistant Scraper
Pressure for determining piston forces	6,3 bar
Retracting piston force	1035 N
Extracting piston force	1235 N
Min. ambient temperature	-10 °C
Max. ambient temperature	150 °C
Min. working pressure	1 bar
Max. working pressure	10 bar
Cushioning length	17 mm
Cushioning energy	15 J
Weight 0 mm stroke	1.38 kg

# Round cylinder, Series RPC

R412020797

Series RPC

2024-04-23

---

Weight +10 mm stroke	0.04 kg
Stroke max.	1200 mm
Medium	Compressed air
Min. medium temperature	-10 °C
Max. medium temperature	150 °C
Max. particle size	50 µm
Min. oil content of compressed air	0 mg/m <sup>3</sup>
Max. oil content of compressed air	5 mg/m <sup>3</sup>
Clamping piece for magnetic field sensor necessary	Clamping piece for magnetic field sensor necessary

## Material

Piston rod	Stainless Steel
Scraper material	Fluorocaoutchouc
Seal material	Fluorocaoutchouc
Material, front cover	Aluminum
Cylinder tube	Stainless Steel
End cover	Aluminum
Nut for piston rod	Steel, chrome-plated
Guide bushing	Steel, chrome-plated
Part No.	R412020797

## Technical information

Ambient temperature with contact query max. [[120] °C]

Use our Internet configurator to order these variants with coarse-pitch thread M10x1.5 or M12x1.75.

The pressure dew point must be at least 15 °C less than ambient and medium temperature and may not exceed 3 °C.

The oil content of compressed air must remain constant during the life cycle.

Use only the approved oils from AVENTICS. Further information can be found in the "Technical information" document (available in <https://www.emerson.com/en-us/support>).

# Round cylinder, Series RPC

R412020797

Series RPC

2024-04-23

## Dimensions

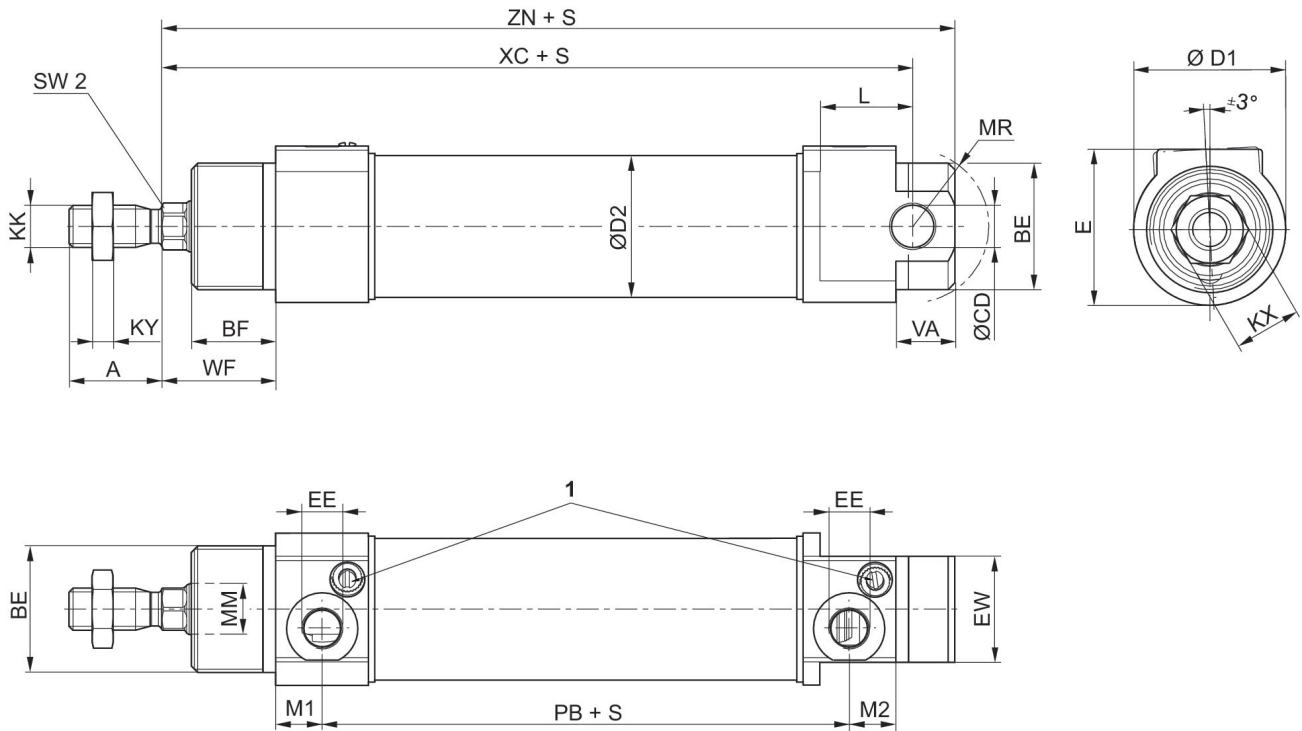

S=stroke

1) Slot in throttle screw 1 mm

Piston $\varnothing$	A	BE	BF	$\varnothing CD$ H8	$\varnothing D1$	$\varnothing D2$	E	EE	EW
32	22	M30x1,5	20	10	36	33.5	37	G 1/8	25
40	24	M38x1,5	23	12	45	41.5	45	G 1/4	30
50	32	M45x1,5	24	12	55	52.5	55	G 1/4	35
63	32	M45x1,5	26.5	16	69	65.4	69	G 3/8	35

Piston $\varnothing$	KK	KX	KY	L min.	$\varnothing$ MM f8	M1	M2	MR	PB
32	M10x1,25*	16	5	22	12	11	11	18	75
40	M12x1,25*	19	6	23	16	11.5	11.5	22.5	87
50	M16x1,5	24	8	26	20	11.5	11.5	25.5	87.5
63	M16x1,5	24	8	29	20	13	13.5	36.5	92

Piston $\varnothing$	SW2	VA	WF	XC	ZN
32	10	14	27	128	138
40	13	15	32	146	157
50	17	18	33.5	151	162
63	17	20	36.5	161	175

# Round cylinder, Series RPC

R412020797

Series RPC

2024-04-23

## Overview drawing

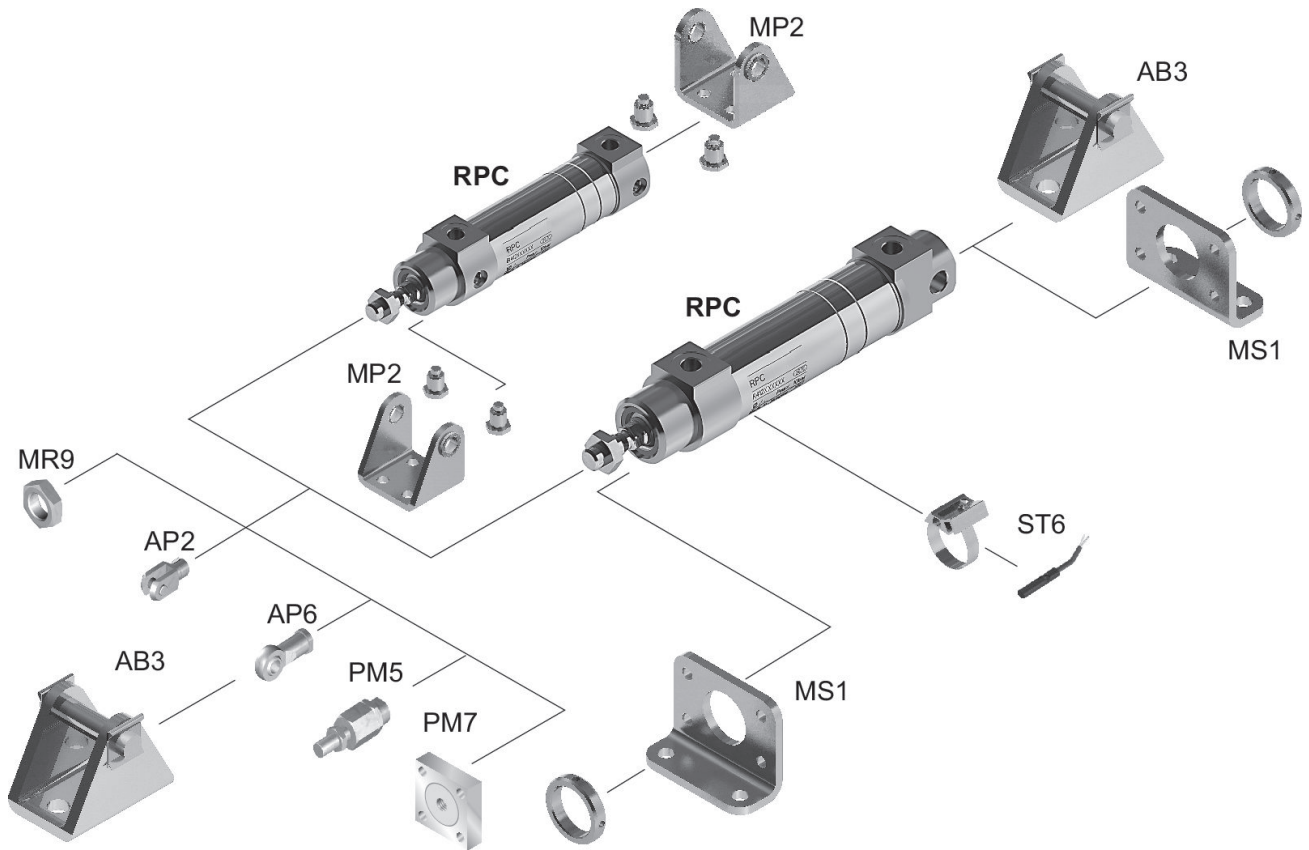

NOTE: This overview drawing is only for orientation to indicate where the various accessory parts can be fastened to the cylinder. The illustration has been simplified for this purpose. It is thus not possible to derive the dimensions from this overview.