

Round cylinder, Series RPC

R481609476

AVENTICS
Series RPC
Round
cylinders

2024-04-05

AVENTICS Series RPC Round cylinders

The AVENTICS Series RPC round profile cylinders offer a wide variety of connection options. They are easy to clean and suitable for packaging applications in the food industry due to food grade lubricants. The Series RPC can also be used in standard applications across machine automation needs.



Technical data

Industry	Industrial
Standards	ISO 6431
Type	Version: ISO-type
Piston Ø	63 mm
Stroke	25 mm
Ports	G 3/8
Functional principle	Single-acting, retracted without pressure
Cushioning	Elastic cushioning
Magnetic piston	Piston with magnet
Environmental requirements	Industry standard
Piston rod thread - type	External thread
Piston rod thread	M16x1,5
Piston rod	single
Scraper	Standard Industry Scraper
Pressure for determining piston forces	6,3 bar
Retracting piston force	1802 N
Extracting piston force	1860 N
Min. ambient temperature	-20 °C
Max. ambient temperature	80 °C

Round cylinder, Series RPC

R481609476

AVENTICS
Series RPC
Round
cylinders

2024-04-05

Min. working pressure	2 bar
Max. working pressure	10 bar
Min. spring force	95 N
Max. spring force	162 N
Impact energy	1.3 J
Weight 0 mm stroke	1.96 kg
Weight +10 mm stroke	0.044 kg
Stroke max.	50 mm
Medium	Compressed air
Min. medium temperature	-20 °C
Max. medium temperature	80 °C
Max. particle size	50 µm
Min. oil content of compressed air	0 mg/m ³
Max. oil content of compressed air	5 mg/m ³
Clamping piece for magnetic field sensor necessary	Clamping piece for magnetic field sensor necessary

Material

Piston rod	Stainless Steel
Scraper material	Polyurethane
Seal material	Polyurethane
Material, front cover	Aluminum
Cylinder tube	Stainless Steel
End cover	Aluminum
Nut for piston rod	Steel, chrome-plated
Part No.	R481609476

Technical information

The pressure dew point must be at least 15 °C less than ambient and medium temperature and may not exceed 3 °C.

The oil content of compressed air must remain constant during the life cycle.

Use only the approved oils from AVENTICS. Further information can be found in the "Technical information" document (available in <https://www.emerson.com/en-us/support>).

Round cylinder, Series RPC

R481609476

AVENTICS
Series RPC
Round
cylinders

2024-04-05

Dimensions

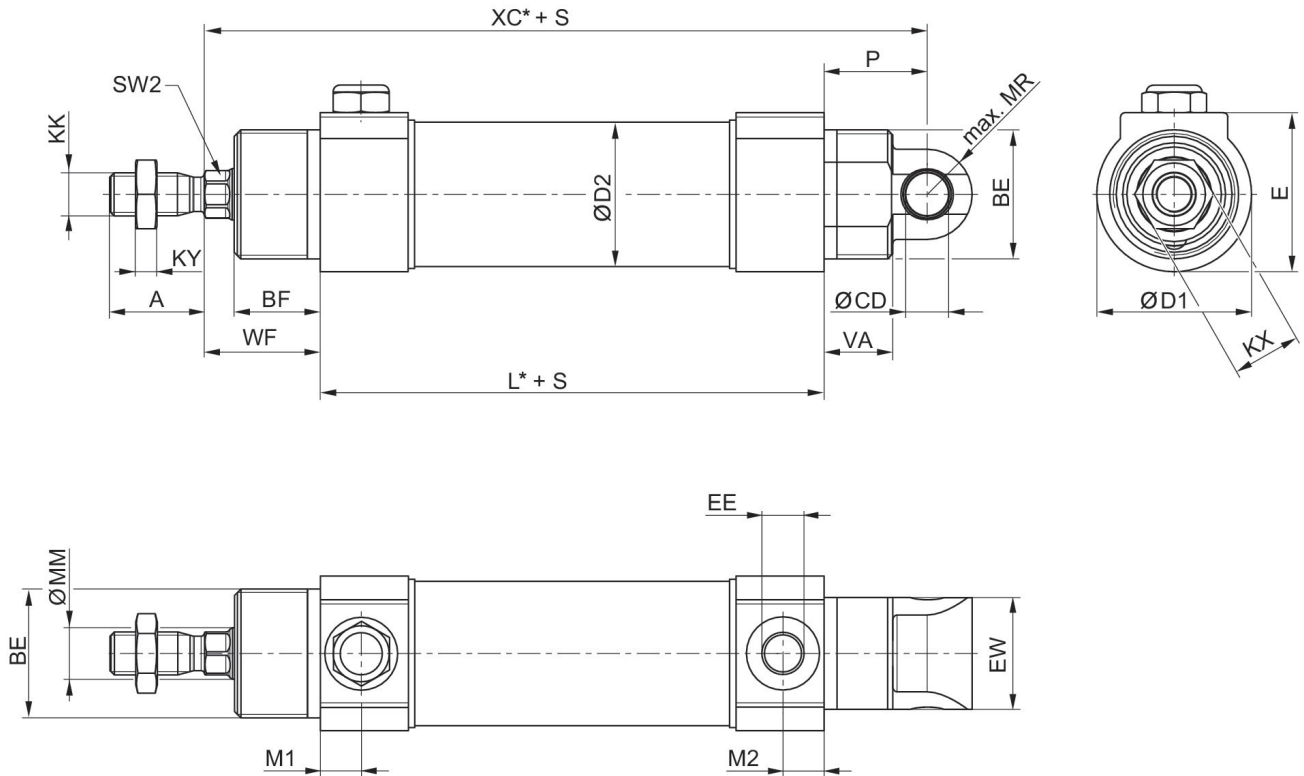

S = stroke

Piston Ø	A	BE	BF	Ø CD H9	Ø D1	Ø D2	E	EE	EW
32	22	M30x1,5	20	10	36	33,6	37	G 1/8	26
40	24	M38x1,5	23	12	45	41,6	45	G 1/4	28
50	32	M45x1,5	24	12	55	52,4	55	G 1/4	32
63	32	M45x1,5	26,5	16	69	65,4	69	G 3/8	40

Piston Ø	KK	KX	KY	L *	Ø MM	M1	M2	MR	P
32	M10x1,25	16	5	92	12	9,5	9,5	10,5	24
40	M12x1,25	18	6	107	16	11,5	11,5	13	21
50	M16x1,5	24	8	110	20	11,5	11,5	13	25
63	M16x1,5	24	8	125	20	13,5	13,5	17	31

Piston Ø	SW2	VA	WF	XC *
32	10	16	27	143
40	13	19	32	160
50	17	18,5	35	170
63	17	23	35	191

* for stroke 26-50 mm, length dimensions XC and L are 25 mm longer

Round cylinder, Series RPC

R481609476

AVENTICS
Series RPC
Round
cylinders

2024-04-05

Overview drawing

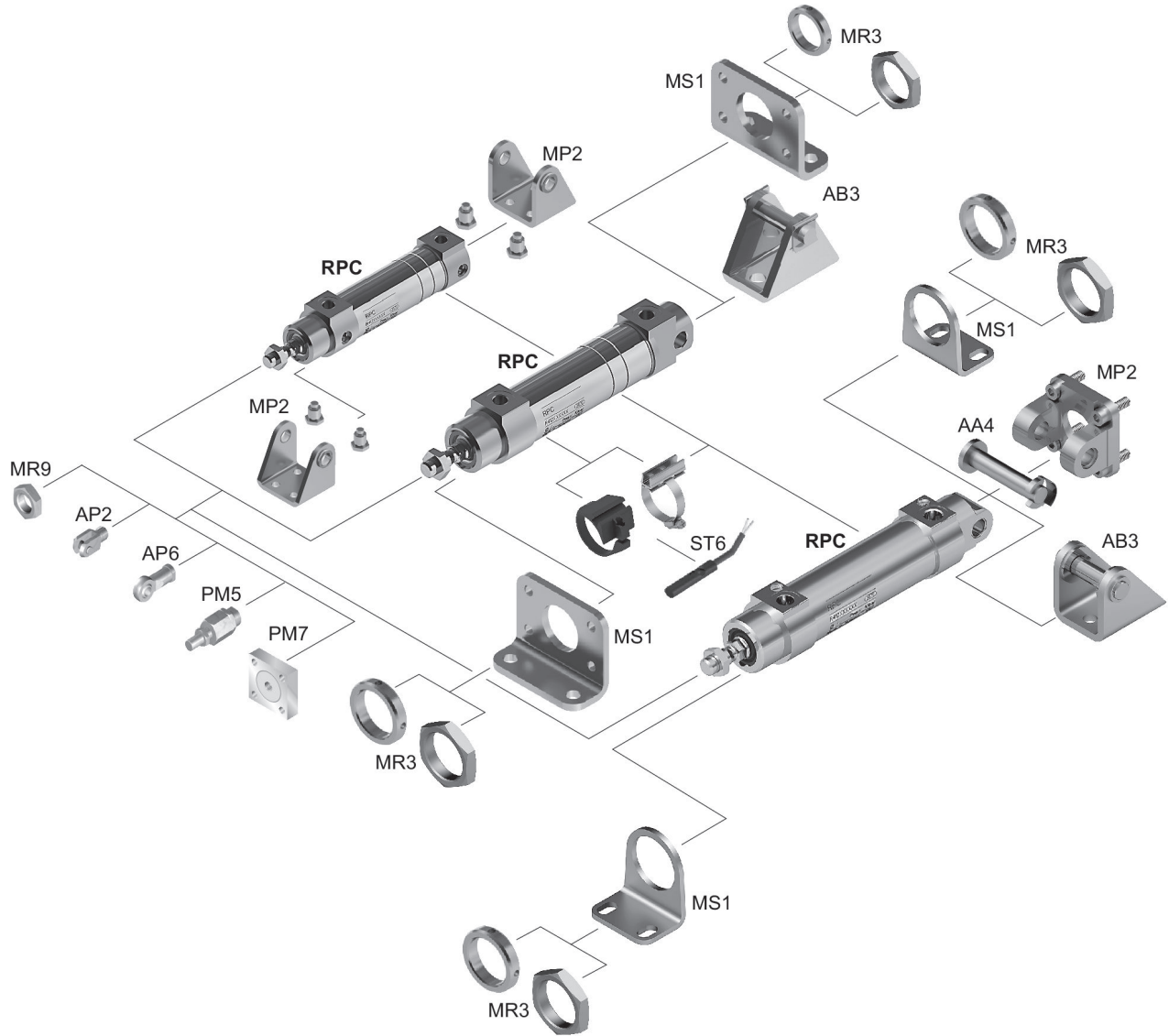

NOTE: This overview drawing is only for orientation to indicate where the various accessory parts can be fastened to the cylinder. The illustration has been simplified for this purpose. It is thus not possible to derive the dimensions from this overview.