

AVENTICS Series RTC Rodless cylinders

The AVENTICS Series RTC rodless cylinders offer optimized stroke length in a compact size. The unique oval piston shape and one-piece slide/piston unit are just two characteristic features of RTC Series rodless cylinders besides their many common equipment options. They are available in four variants: as a basic version, slide bearing, compact guide and heavy duty versions for large loads. With different key strengths, they cover a large range of movements and positions. This saves space and facilitates machine design. The range of applications extends from piston diameters of 16 mm up to 80 mm and stroke lengths up to 9900 mm. The cylinders feature extreme repeatability and cover a large speed range from 0.01 m/s to >20 m/s.



Technical data

Industry	Industrial
Piston Ø	32 mm
Stroke	152.4 mm
Functional principle	Double-acting
Magnetic piston	with magnetic piston
Guide	ball rail guide
Version rodless cylinder	Compact Guide
Easy2Combine	Easy2Combine capable with connection kit
Piston force	507 N
Pressure for determining piston forces	6,3 bar
Cushioning length	20 mm
Cushioning energy	7 J
Cushioning	Pneumatically
Cushioning	adjustable
Max. speed	2 m/s
Stroke max.	1800 mm
Min. working pressure	2 bar
Max. working pressure	8 bar
Min. ambient temperature	-10 °C

Max. ambient temperature	60 °C
Medium	Compressed air
Min. oil content of compressed air	0 mg/m ³
Max. oil content of compressed air	1 mg/m ³
Max. particle size	5 µm
Weight 0 mm stroke	2.43 kg
Weight +10 mm stroke	0.056 kg

Material

Material cylinder tube	Aluminum
Surface cylinder tube	anodized
Material front cover	Aluminum
Surface cover	anodized
Seal material	Polyurethane
Material sealing strips	Polyurethane Stainless Steel
Material guide rail	Aluminum
Surface ball rail table	anodized
Material guide rail	Steel, chrome-plated
Surface guide rail	hardened
Part No.	R480639375

Technical information

The pressure dew point must be at least 15 °C less than ambient and medium temperature and may not exceed 3 °C.

The delivered product is lubricated for lifetime.

Use hydraulic shock absorbers for precise end position adjustment.

These pneumatic components with NPT or inch thread dimensions are only available from our US sales organization.

Thread depth: 0.47 inch for piston Ø 5/8, 1 and 1 1/2. 0.41 inch for piston Ø 1 1/4

Thread depth: 0.50 inch for piston Ø 5/8 - 1 1/2

Thread depth: 0.35 inch for piston Ø 5/8 - 1 1/2

Thread depth: 0.40 inch for piston Ø 5/8 - 1 1/2

Can be selected in the configurator (M7 for high-speed applications)

The pressure dew point must be at least 15 °C less than ambient and medium temperature and may not exceed 3 °C.

The oil content of compressed air must remain constant during the life cycle.

Use only the approved oils from AVENTICS. Further information can be found in the "Technical information" document (available in <https://www.emerson.com/en-us/support>).

Rodless cylinders, Series RTC-CG

R480639375

RTC

2024-05-14

Dimensions in inches

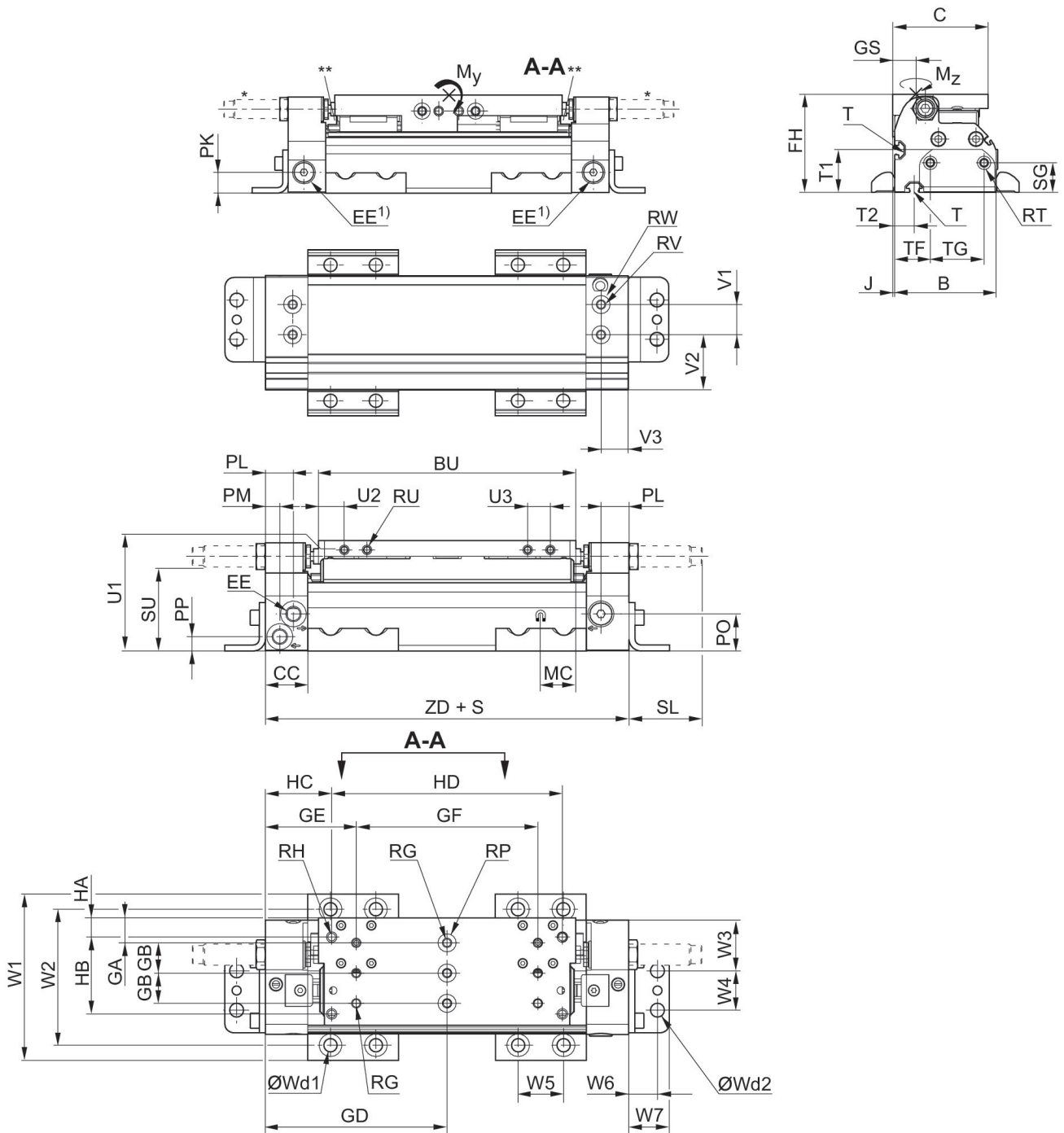

S = stroke

T = Type of t-groove nut

1) Auxiliary air feeding

An example configuration is illustrated. The delivered product may thus deviate from the illustration.

* Shock absorber optional in end cover for diameters 16-40

** RTC-CG 16 & 25: 2x Lube ports on each runner block, RTC-CG 32 & 40: Lube nipple of funnel type with thread connection M3

Rodless cylinders, Series RTC-CG

R480639375

RTC

2024-05-14

Dimensions in inches

Piston Ø	Part No.	B	C	BU	CC	EE	FH	GA	GB
32 mm	R480161097	1.97	2.01	4.8	1.1	*10-32/M7	2.13	0.28	0.79
32 mm	R480676520	2.46	2.29	5.79	1.1	1/8 NPTF	2.56	0.24	0.79
32 mm	R480639375	2.97	2.8	6.69	1.1	1/8 NPTF	2.87	0.65	0.79
32 mm	R480676522	3.37	2.91	7.32	1.1	1/8 NPTF	3.72	0.65	0.79

Piston Ø	GD	GE	GF	GS	HA	HB	HC	HD	J
32 mm	3.68	1.52	4.33	0.45	0.3	1.5	2.68	2	0.08
32 mm	4.23	2.11	4.25	0.59	0.2	1.8	1.53	5.4	0.06
32 mm	4.72	2.36	4.72	0.69	0.5	2	1.72	6	0.06
32 mm	5.18	2.82	4.72	0.73	0.5	2	2.18	6	0.06

Piston Ø	MC	PK	PL	PM	PN	PO	PP	RG 1)	RH 2)
32 mm	0.47	0.47	0.71	0.28	0.28	0.52	0.29	M5	4xUNC 1/4-20
32 mm	0.59	0.4	0.79	0.31	0.35	0.85	0.37	M5	4xUNC 1/4-20
32 mm	0.79	0.59	0.73	0.37	0.47	0.96	0.37	M6	4xUNC 1/4-20
32 mm	0.67	0.71	0.71	0.39	0.43	1.24	0.41	M6	4xUNC 1/4-20

Piston Ø	RP	RT 3)	RU 4)	SG	SL	SU	T	W1	W2
32 mm	Ø 9	M5	M5	0.68	1.31	1.52	N4	3.09	2.42
32 mm	Ø 9	M5	M6	0.68	1.94	1.85	N6	3.58	2.91
32 mm	Ø 12	M6	M6	0.87	1.9	2.19	N6	4.33	3.54
32 mm	Ø 12	M6	M6	0.87	1.78	2.89	N6	4.72	3.93

Piston Ø	W3	W4	W5	W6	W7	Wd1	Wd2	T1	T2
32 mm	0.94	0.71	1.18	0.53	0.78	M6	M6	0.73	0.41
32 mm	0.14	0.71	1.18	0.53	0.78	M6	M6	1.05	0.53
32 mm	1.32	1.02	1.18	0.75	1.06	M8	M8	1.24	0.57
32 mm	1.48	1.02	1.18	0.75	1.06	M8	M8	1.63	0.51

Piston Ø	TF	TG	U1	U2	U3	ZD	Moving mass kg
32 mm	1	0.75	1.89	0.51	0.59	7.36	0.485
32 mm	1.22	0.75	2.32	0.51	1.06	8.46	0.882
32 mm	1.04	1.57	2.64	0.67	1.34	9.45	1.036
32 mm	1.2	1.57	3.13	0.98	1.34	10.36	2.138

Max. play and recommended max.
lever arm length

Rodless cylinders, Series RTC-CG

R480639375

RTC

2024-05-14

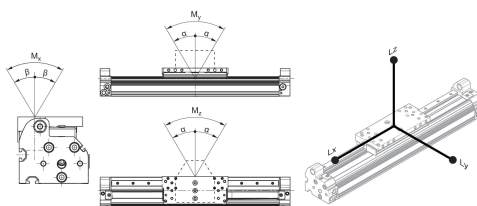

L = lever arm

M = moment (Nm)

Part No.	Piston Ø	Ø [inch]	α	β	Lx	Ly	Lz
R480161097	32 mm	5/8	<0,1°	<0,2°	328	328	328
R480676520	32 mm	1	<0,1°	<0,2°	424	424	424
R480639375	32 mm	1 1/4	<0,1°	<0,2°	480	480	480

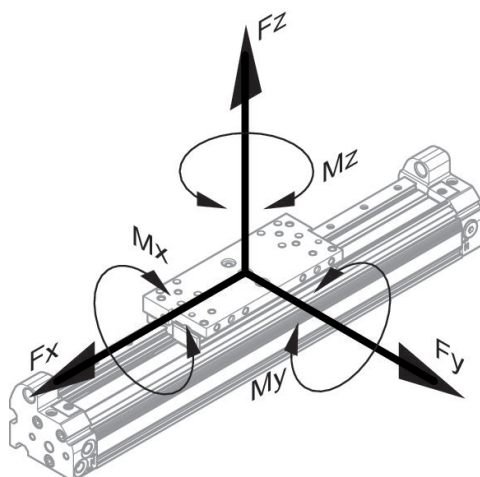

dynamic

Part No.	Piston Ø	Ø [inch]	Mx [Nm]	My [Nm]	Mz [Nm]
R480161097	32 mm	5/8	4	30	30
R480676520	32 mm	1	10	78	78
R480639375	32 mm	1 1/4	22	158	110

static

Part No.	Piston Ø	Ø [inch]	Fx [N]	Fy [N]	Fz [N]	Mx [Nm]	My [Nm]	Mz [Nm]
R480161097	32 mm	5/8	744	744	744	4	30	30
R480676520	32 mm	1	1456	1456	1456	10	78	78
R480639375	32 mm	1 1/4	1840	1840	2646	22	158	110