

Rodless cylinders, Series RTC-SB

R481608224

AVENTICS
Series RTC
Rodless
cylinders

2024-04-22

AVENTICS Series RTC Rodless cylinders

The AVENTICS Series RTC rodless cylinders offer optimized stroke length in a compact size. The unique oval piston shape and one-piece slide/piston unit are just two characteristic features of RTC Series rodless cylinders besides their many common equipment options. They are available in four variants: as a basic version, slide bearing, compact guide and heavy duty versions for large loads. With different key strengths, they cover a large range of movements and positions. This saves space and facilitates machine design. The range of applications extends from piston diameters of 16 mm up to 80 mm and stroke lengths up to 9900 mm. The cylinders feature extreme repeatability and cover a large speed range from 0.01 m/s to >20 m/s.



Technical data

Industry	Industrial
Piston Ø	32 mm
Stroke	400 mm
Ports	G 1/8
Functional principle	Double-acting
Magnetic piston	with magnetic piston
Guide	Slide bearing guide
Piston force	507 N
Pressure for determining piston forces	6,3 bar
Cushioning length	20 mm
Cushioning energy	7 J
Cushioning	Pneumatically
Cushioning	adjustable
Max. speed	0.8 m/s
Stroke max.	9900 mm
Min. working pressure	2 bar
Max. working pressure	8 bar
Min. ambient temperature	-25 °C
Max. ambient temperature	60 °C

Rodless cylinders, Series RTC-SB

R481608224

AVENTICS
Series RTC
Rodless
cylinders

2024-04-22

Medium	Compressed air
Min. oil content of compressed air	0 mg/m ³
Max. oil content of compressed air	1 mg/m ³
Max. particle size	5 µm
Weight 0 mm stroke	2.85 kg
Weight +10 mm stroke	0.049 kg

Material

Material cylinder tube	Aluminum
Surface cylinder tube	anodized
Material front cover	Aluminum
Surface cover	anodized
Seal material	Polyurethane
Material sealing strips	Polyurethane Stainless Steel
Material guide rail	Aluminum
Surface ball rail table	anodized
Part No.	R481608224

Technical information

The pressure dew point must be at least 15 °C less than ambient and medium temperature and may not exceed 3 °C.

The delivered product is lubricated for lifetime.

The pressure dew point must be at least 15 °C less than ambient and medium temperature and may not exceed 3 °C.

The oil content of compressed air must remain constant during the life cycle.

Use only the approved oils from AVENTICS. Further information can be found in the "Technical information" document (available in <https://www.emerson.com/en-us/support>).

Rodless cylinders, Series RTC-SB

R481608224

AVENTICS
Series RTC
Rodless
cylinders

2024-04-22

Dimensions in mm

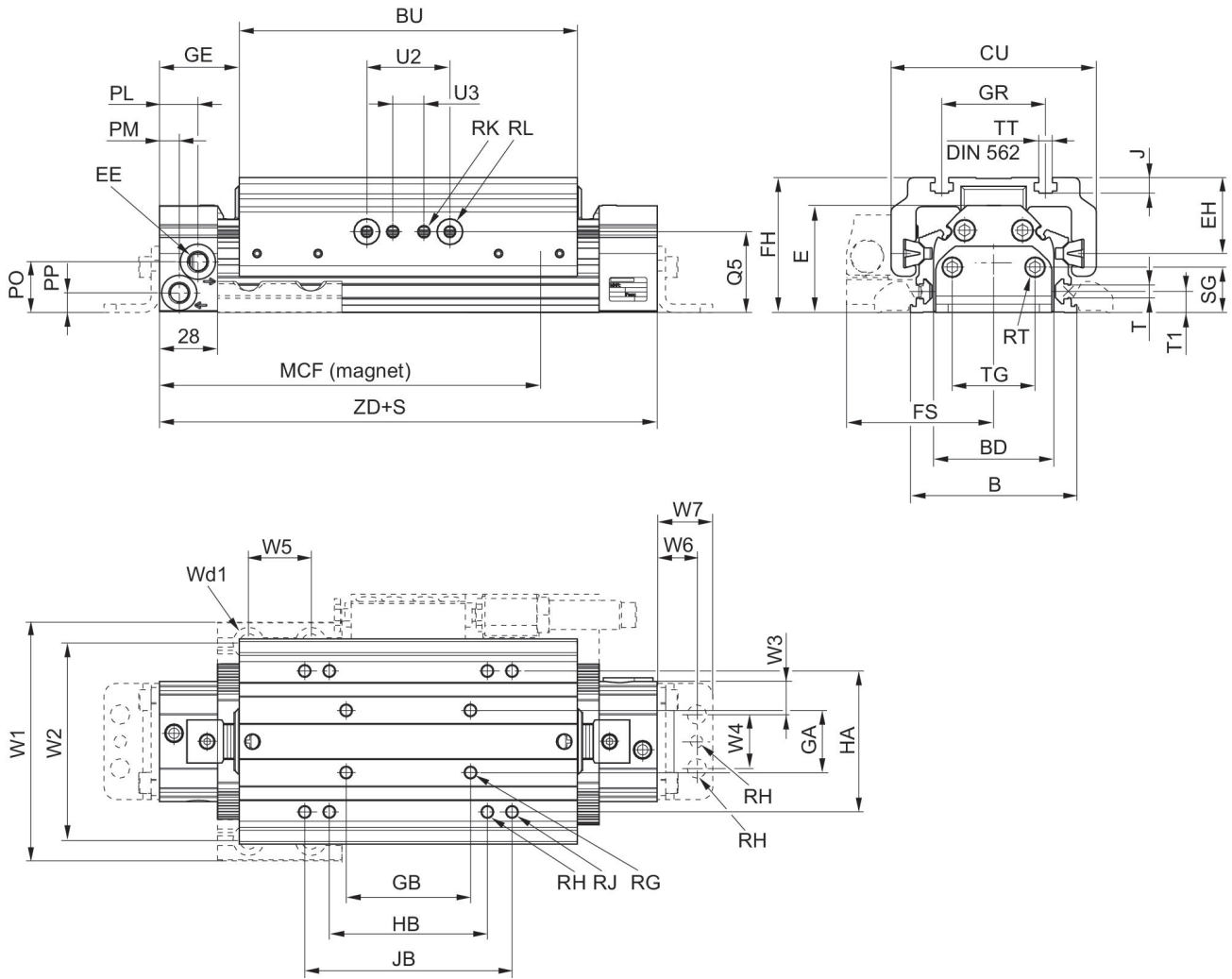

S = stroke

Dimensions

Piston Ø	Part No.	B	BU	BD	CU	EE	EH	FH	FS
32 mm	R481608221	80,3	163	58	99	G 1/8	36,6	65.1	71
32 mm	R481608231	89,3	182	70	108	G 1/4	41	71	75.5
32 mm	R481608241	117,5	205	92	134	G 1/4	37,6	78,2	97.5

Piston Ø	GA	GB	GE	GR	HA	HB	J	JB	MCF
32 mm	30	60	38.5	50	68	76.2	7.5	100	182
32 mm	30	60	40.5	50	80	101.6	7.5	120	205
32 mm	40	60	44.6	70	100	127	9.8	160	230

Piston Ø	PL	PM	PO	PP	Q5	RG	RH	RJ	RK
32 mm	18.5	9.5	24.5	9.5	39	M6	1/4-28 UNF	M6	M6
32 mm	18	10	31.5	11	44.6	M6	1/4-28 UNF	M6	M6

Rodless cylinders, Series RTC-SB

R481608224

AVENTICS
Series RTC
Rodless
cylinders

Piston Ø	PL	PM	PO	PP	Q5	RG	RH	RJ	RK
32 mm	16	16	35,3	12,3	68.6	M8	1/4-28 UNF	M8	M8

Piston Ø	RL	RT 1)	SG	T	TT	T1	TG	U2	U3
32 mm	Ø12.01 H7	M6	22	N6	M6	10.1	40	40	15
32 mm	Ø12.01 H7	M6	22	N6	M6	11.2	40	40	15
32 mm	Ø12.01 H7	M8	22	M8	M8	14.1	40	72	40

Piston Ø	W1	W2	W3	W4	W5	W6	W7	Wd1	Wd2
32 mm	115	95	15	26	30	19	26.8	Ø8.8	Ø9.2
32 mm	124	104	15	26	30	19	26.8	Ø8.8	Ø9.2
32 mm	165	140	11	70	40	22	32.7	Ø13	Ø13.7

Piston Ø	Wd3	ZD
32 mm	Ø6G8	240
32 mm	Ø6G8	263
32 mm	Ø6G8	294

1) thread depth: 6 mm

For long slide

Piston Ø	Part No.	BU	HB	JB	MCF	ZD
32 mm	R481608221	326	101.6	200	345	403
32 mm	R481608231	364	127	240	388	445
32 mm	R481608241	410	152.4	240	434	499

Max. play and recommended max.
lever arm length

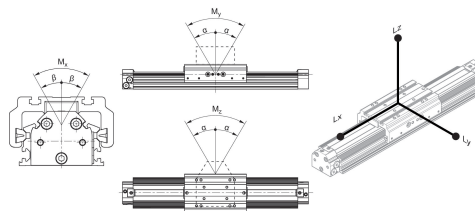

L = lever arm

M = moment (Nm)

For long slide

Part No.	Piston Ø	α	β	Lx	Ly	Lz
R481608221	32 mm	$\leq 0,1^\circ$	$\leq 0,3^\circ$	610	320	610
R481608231	32 mm	$\leq 0,1^\circ$	$\leq 0,3^\circ$	610	320	610

Rodless cylinders, Series RTC-SB

R481608224

AVENTICS
Series RTC
Rodless
cylinders

2024-04-22

Part No.	Piston Ø	α	β	Lx	Ly	Lz
R481608221	32 mm	$\leq 0,2^\circ$	$\leq 0,3^\circ$	240	120	240
R481608231	32 mm	$\leq 0,2^\circ$	$\leq 0,3^\circ$	240	120	240

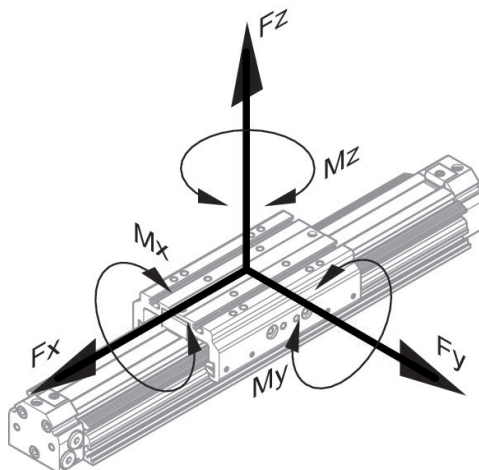

For long slide

Part No.	Piston Ø	Mx [Nm]	My [Nm]	Mz [Nm]
R481608221	32 mm	6	90	90
R481608231	32 mm	8	100	100

static

Part No.	Piston Ø	Fx [N]	Fy [N]	Fz [N]	Mx [Nm]	My [Nm]	Mz [Nm]
R481608221	32 mm	2200	1000	2600	73	91	91
R481608231	32 mm	2700	1000	2600	83	111	111

dynamic

Part No.	Piston Ø	Mx [Nm]	My [Nm]	Mz [Nm]
R481608221	32 mm	6	45	45
R481608231	32 mm	8	50	50

Rodless cylinders, Series RTC-SB

R481608224

AVENTICS
Series RTC
Rodless
cylinders

2024-04-22

static, for long slide

Part No.	Piston Ø	F _x [N]	F _y [N]	F _z [N]	M _x [Nm]	M _y [Nm]	M _z [Nm]
R481608171	32 mm	2200	550	6600	36	160	86
R481608181	32 mm	3500	650	8000	56	280	110
R481608191	32 mm	5000	750	9000	70	460	140
R481608201	32 mm	6800	850	13000	90	680	180