

Rodless cylinders, Series RTC-CG

R480156962

AVENTICS
Series RTC
Rodless
cylinders

2024-04-22

AVENTICS Series RTC Rodless cylinders

The AVENTICS Series RTC rodless cylinders offer optimized stroke length in a compact size. The unique oval piston shape and one-piece slide/piston unit are just two characteristic features of RTC Series rodless cylinders besides their many common equipment options. They are available in four variants: as a basic version, slide bearing, compact guide and heavy duty versions for large loads. With different key strengths, they cover a large range of movements and positions. This saves space and facilitates machine design. The range of applications extends from piston diameters of 16 mm up to 80 mm and stroke lengths up to 9900 mm. The cylinders feature extreme repeatability and cover a large speed range from 0.01 m/s to >20 m/s.

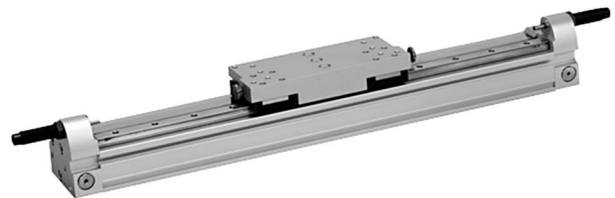

Technical data

Industry	Industrial
Piston Ø	32 mm
Stroke	900 mm
Ports	G 1/8
Functional principle	Double-acting
Magnetic piston	with magnetic piston
Guide	ball rail guide
Version rodless cylinder	Compact Guide
Easy2Combine	Easy2Combine capable with connection kit
Piston force	507 N
Pressure for determining piston forces	6,3 bar
Cushioning length	20 mm
Cushioning energy	7 J
Cushioning	Pneumatically
Cushioning	adjustable
Max. speed	2 m/s
Stroke max.	1800 mm
Min. working pressure	2 bar
Max. working pressure	8 bar

Rodless cylinders, Series RTC-CG

R480156962

AVENTICS
Series RTC
Rodless
cylinders

2024-04-22

Min. ambient temperature	-10 °C
Max. ambient temperature	60 °C
Medium	Compressed air
Min. oil content of compressed air	0 mg/m ³
Max. oil content of compressed air	1 mg/m ³
Max. particle size	5 µm
Weight 0 mm stroke	2.43 kg
Weight +10 mm stroke	0.056 kg

Material

Material cylinder tube	Aluminum
Surface cylinder tube	anodized
Material front cover	Aluminum
Surface cover	anodized
Seal material	Polyurethane
Material sealing strips	Polyurethane Stainless Steel
Material guide rail	Aluminum
Surface ball rail table	anodized
Material guide rail	Steel, chrome-plated
Surface guide rail	hardened
Part No.	R480156962

Technical information

The pressure dew point must be at least 15 °C less than ambient and medium temperature and may not exceed 3 °C.

The delivered product is lubricated for lifetime.

Use hydraulic shock absorbers for precise end position adjustment.

thread depth: 12 mm for piston Ø 16, 25 & 40 mm, 10,5 mm for piston Ø 32

thread depth: 12,7 mm for piston Ø 16–40 mm

thread depth: 9 mm for piston Ø 16–40 mm

thread depth: 10 mm for piston Ø 16–40 mm

The pressure dew point must be at least 15 °C less than ambient and medium temperature and may not exceed 3 °C.

The oil content of compressed air must remain constant during the life cycle.

Use only the approved oils from AVENTICS. Further information can be found in the “Technical information” document (available in <https://www.emerson.com/en-us/support>).

Rodless cylinders, Series RTC-CG

R480156962

AVENTICS
Series RTC
Rodless
cylinders

2024-04-22

Dimensions

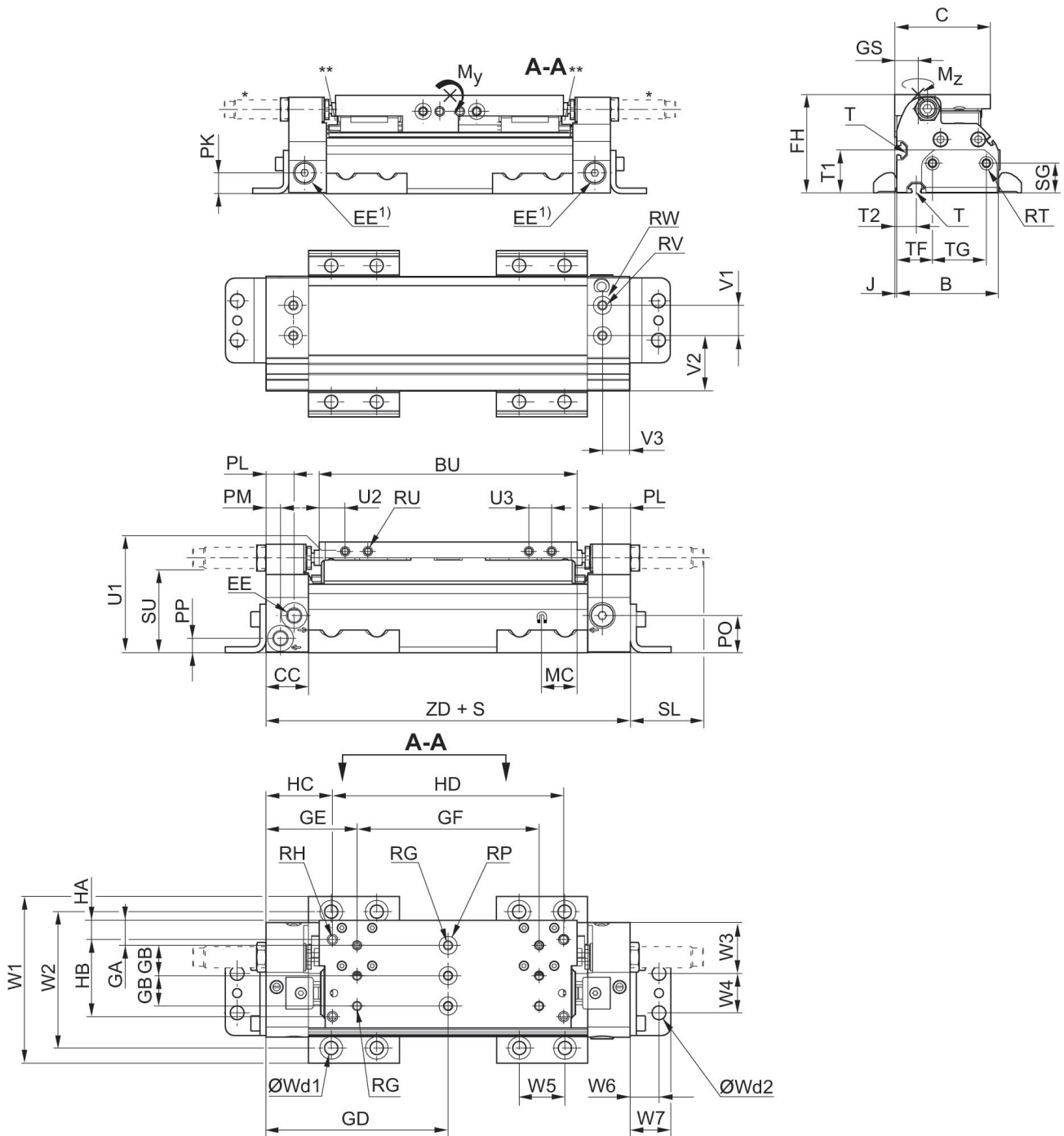

S = stroke

T = Type of t-groove nut

1) Auxiliary air feeding

An example configuration is illustrated. The delivered product may thus deviate from the illustration.

* Shock absorber optional in end cover for diameters 16-40

** RTC-CG 16 & 25: 2x Lube ports on each runner block, RTC-CG 32 & 40: Lube nipple of funnel type with thread connection M3

Rodless cylinders, Series RTC-CG

R480156962

AVENTICS
Series RTC
Rodless
cylinders

2024-04-22

Piston Ø	Part No.	B	C	BU	CC	EE	FH	GA	GB
32 mm	R480148169	50	51	122	28	3xM7	54	7	20
32 mm	R480146993	62.5	58.1	147	28	3xG 1/8	65	6	20
32 mm	R480154848	75.5	71	170	28	3xG 1/8	73	16.5	20
32 mm	R480156966	85.5	74	186	28	3xG 1/4	94.4	16.5	20

Piston Ø	GD	GE	GF	GS	HA	HB	HC	HD	J
32 mm	93.5	38.5	110	11.5	7.6	38.1	68.1	50.8	2
32 mm	107.5	53.5	108	15	5.1	45.7	38.9	137.2	1.5
32 mm	120	60	120	17.5	12.7	50.8	43.8	152.4	1.5
32 mm	131.6	71.6	120	18.5	12.7	50.8	55.4	152.4	1.5

Piston Ø	MC	PK	PL	PM	PN	PO	PP	RG 1)	RH 2)
32 mm	12	11.9	18	7	7	13.3	7.3	M5	UNC 1/4-20
32 mm	15	10.1	20	8	9	21.5	9.3	M5	UNC 1/4-20
32 mm	20	15	18.5	9.5	12	24.5	9.5	M6	UNC 1/4-20
32 mm	17	18	18	10	11	31.5	10.5	M6	UNC 1/4-20

Piston Ø	RP	RT 3)	RU 4)	RV	RW	SG	SL	SU	T
32 mm	Ø 9	M5	M5	M5x8	Ø 9H8x1,6	17.3	33.2	38.6	N4
32 mm	Ø 9	M5	M6	M5x8	Ø 9H8x1,6	17.3	49.3	47.1	N6
32 mm	Ø 12	M6	M6	M6x10	Ø 12H8x2,1	22	48.3	55.5	N6
32 mm	Ø 12	M6	M6	M6x10	Ø 12H8x2,1	22	45.1	73.4	N6

Piston Ø	V1	V2	V3	W1	W2	W3	W4	W5	W6
32 mm	20	6	14	78.4	61.4	24	18	30	13.5
32 mm	20	26.5	18	90.9	73.9	31.5	18	30	13.5
32 mm	20	36.5	18	109.9	89.9	33.5	26	30	19
32 mm	20	40.5	18	119.9	99.9	37.5	26	30	19

Piston Ø	W7	Wd1	Wd2	T1	T2	TF	TG	U1	U2
32 mm	19.8	M6	M6	18.5	10.5	25.5	19	48	13
32 mm	19.8	M6	M6	26.6	13.5	31	19	59	12.5
32 mm	26.8	M8	M8	31.5	14.5	26.5	40	67	17
32 mm	26.8	M8	M8	41.4	13	30.5	40	79.4	25

Piston Ø	U3	ZD	Moving mass kg
32 mm	15	187	0.22
32 mm	27	215	0.4
32 mm	34	240	0.47
32 mm	34	263.1	0.97

Max. play and recommended max.
lever arm length

Rodless cylinders, Series RTC-CG

R480156962

AVENTICS
Series RTC
Rodless
cylinders

2024-04-22

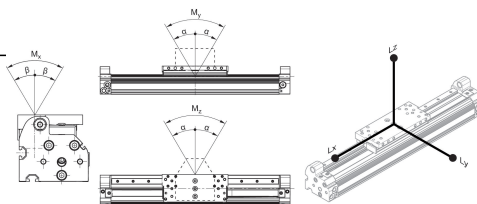

L = lever arm

M = moment (Nm)

Part No.	Piston Ø	α	β	Lx	Ly	Lz
R480148169	32 mm	<0,1°	<0,2°	328	328	328
R480148470	32 mm	<0,1°	<0,2°	328	328	328
R480153838	32 mm	<0,1°	<0,2°	328	328	328
R480147715	32 mm	<0,1°	<0,2°	328	328	328
R480146105	32 mm	<0,1°	<0,2°	328	328	328
R480156308	32 mm	<0,1°	<0,2°	328	328	328
R480146993	32 mm	<0,1°	<0,2°	424	424	424
R480146765	32 mm	<0,1°	<0,2°	424	424	424
R480147184	32 mm	<0,1°	<0,2°	424	424	424
R480146182	32 mm	<0,1°	<0,2°	424	424	424
R480147519	32 mm	<0,1°	<0,2°	424	424	424
R480146193	32 mm	<0,1°	<0,2°	424	424	424
R480148254	32 mm	<0,1°	<0,2°	424	424	424
R480154848	32 mm	<0,1°	<0,2°	480	480	480
R480154708	32 mm	<0,1°	<0,2°	480	480	480
R480148680	32 mm	<0,1°	<0,2°	480	480	480
R480146674	32 mm	<0,1°	<0,2°	480	480	480
R480146692	32 mm	<0,1°	<0,2°	480	480	480
R480146396	32 mm	<0,1°	<0,2°	480	480	480
R480153429	32 mm	<0,1°	<0,2°	480	480	480
R480156962	32 mm	<0,1°	<0,2°	480	480	480
R480153428	32 mm	<0,1°	<0,2°	480	480	480
R480156966	32 mm	<0,1°	<0,2°	532	532	532
R480150407	32 mm	<0,1°	<0,2°	532	532	532
R480153577	32 mm	<0,1°	<0,2°	532	532	532
R480146348	32 mm	<0,1°	<0,2°	532	532	532
R480149794	32 mm	<0,1°	<0,2°	532	532	532
R480156967	32 mm	<0,1°	<0,2°	532	532	532
R480146347	32 mm	<0,1°	<0,2°	532	532	532
R480156968	32 mm	<0,1°	<0,2°	532	532	532

Rodless cylinders, Series RTC-CG

R480156962

AVENTICS
Series RTC
Rodless
cylinders

2024-04-22

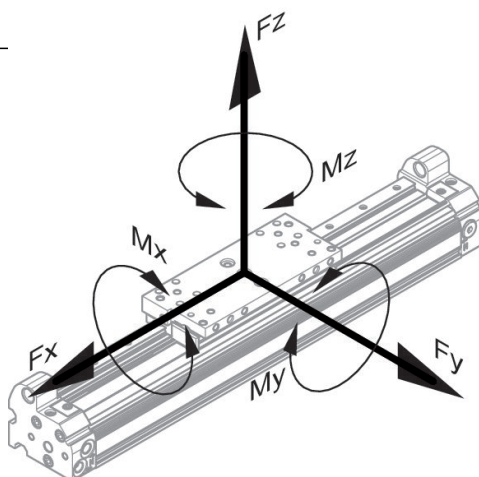

static

Part No.	Piston Ø	Fx [N]	Fy [N]	Fz [N]	Mx [Nm]	My [Nm]	Mz [Nm]
R480148169	32 mm	744	744	744	4	30	30
R480148470	32 mm	744	744	744	4	30	30
R480153838	32 mm	744	744	744	4	30	30
R480147715	32 mm	744	744	744	4	30	30
R480146105	32 mm	744	744	744	4	30	30
R480156308	32 mm	744	744	744	4	30	30
R480146993	32 mm	1456	1456	1456	10	78	78
R480146765	32 mm	1456	1456	1456	10	78	78
R480147184	32 mm	1456	1456	1456	10	78	78
R480146182	32 mm	1456	1456	1456	10	78	78
R480147519	32 mm	1456	1456	1456	10	78	78
R480146193	32 mm	1456	1456	1456	10	78	78
R480148254	32 mm	1456	1456	1456	10	78	78
R480154848	32 mm	1840	1840	2646	22	158	110
R480154708	32 mm	1840	1840	2646	22	158	110
R480148680	32 mm	1840	1840	2646	22	158	110
R480146674	32 mm	1840	1840	2646	22	158	110
R480146692	32 mm	1840	1840	2646	22	158	110
R480146396	32 mm	1840	1840	2646	22	158	110
R480153429	32 mm	1840	1840	2646	22	158	110
R480156962	32 mm	1840	1840	2646	22	158	110
R480153428	32 mm	1840	1840	2646	22	158	110
R480156966	32 mm	1640	1640	4284	36	284	109
R480150407	32 mm	1640	1640	4284	36	284	109
R480153577	32 mm	1640	1640	4284	36	284	109
R480146348	32 mm	1640	1640	4284	36	284	109
R480149794	32 mm	1640	1640	4284	36	284	109
R480156967	32 mm	1640	1640	4284	36	284	109
R480146347	32 mm	1640	1640	4284	36	284	109

Rodless cylinders, Series RTC-CG

R480156962

AVENTICS
Series RTC
Rodless
cylinders

2024-04-22

Part No.	Piston Ø	Fx [N]	Fy [N]	Fz [N]	Mx [Nm]	My [Nm]	Mz [Nm]
R480156968	32 mm	1640	1640	4284	36	284	109

dynamic

Part No.	Piston Ø	Mx [Nm]	My [Nm]	Mz [Nm]
R480148169	32 mm	4	30	30
R480148470	32 mm	4	30	30
R480153838	32 mm	4	30	30
R480147715	32 mm	4	30	30
R480146105	32 mm	4	30	30
R480156308	32 mm	4	30	30
R480146993	32 mm	10	78	78
R480146765	32 mm	10	78	78
R480147184	32 mm	10	78	78
R480146182	32 mm	10	78	78
R480147519	32 mm	10	78	78
R480146193	32 mm	10	78	78
R480148254	32 mm	10	78	78
R480154848	32 mm	22	158	110
R480154708	32 mm	22	158	110
R480148680	32 mm	22	158	110
R480146674	32 mm	22	158	110
R480146692	32 mm	22	158	110
R480146396	32 mm	22	158	110
R480153429	32 mm	22	158	110
R480156962	32 mm	22	158	110
R480153428	32 mm	22	158	110
R480156966	32 mm	36	284	109
R480150407	32 mm	36	284	109
R480153577	32 mm	36	284	109
R480146348	32 mm	36	284	109
R480149794	32 mm	36	284	109
R480156967	32 mm	36	284	109
R480146347	32 mm	36	284	109
R480156968	32 mm	36	284	109