

AVENTICS Series RTC Rodless cylinders

The AVENTICS Series RTC rodless cylinders offer optimized stroke length in a compact size. The unique oval piston shape and one-piece slide/piston unit are just two characteristic features of RTC Series rodless cylinders besides their many common equipment options. They are available in four variants: as a basic version, slide bearing, compact guide and heavy duty versions for large loads. With different key strengths, they cover a large range of movements and positions. This saves space and facilitates machine design. The range of applications extends from piston diameters of 16 mm up to 80 mm and stroke lengths up to 9900 mm. The cylinders feature extreme repeatability and cover a large speed range from 0.01 m/s to >20 m/s.



Technical data

Industry	Industrial
Piston Ø	40 mm
Stroke	1219.2 mm
Functional principle	Double-acting
Magnetic piston	with magnetic piston
Guide	integrated guide
Version rodless cylinder	Basic Version
Piston force	792 N
Pressure for determining piston forces	6,3 bar
Cushioning length	20 mm
Cushioning energy	10 J
Cushioning	Pneumatically
Cushioning	adjustable
Max. speed	5 m/s
Stroke max.	9900 mm
Min. working pressure	2 bar
Max. working pressure	8 bar
Min. ambient temperature	-10 °C
Max. ambient temperature	60 °C

Medium	Compressed air
Min. oil content of compressed air	0 mg/m ³
Max. oil content of compressed air	1 mg/m ³
Max. particle size	5 µm
Weight 0 mm stroke	2.09 kg
Weight +10 mm stroke	0.044 kg

Material

Material cylinder tube	Aluminum
Surface cylinder tube	anodized
Material front cover	Aluminum
Surface cover	anodized
Seal material	Polyurethane
Material sealing strips	Polyurethane Stainless Steel
Material guide rail	Aluminum
Surface ball rail table	anodized
Part No.	R480635629

Technical information

The pressure dew point must be at least 15 °C less than ambient and medium temperature and may not exceed 3 °C.

The delivered product is lubricated for lifetime.

These pneumatic components with NPT or inch thread dimensions are only available from our US sales organization.

Thread depth: 0.35 inch for piston Ø 5/8 - 1 1/2, 0.47 inch for piston Ø 5/8 - 3

Thread depth: 0.24 inch for piston Ø 5/8 - 1, 0.40 inch for piston Ø 1 1/4 - 2, 0.59 inch for piston Ø 2 1/2 - 3

Can be selected in the configurator (M7 for high-speed applications)

The pressure dew point must be at least 15 °C less than ambient and medium temperature and may not exceed 3 °C.

The oil content of compressed air must remain constant during the life cycle.

Use only the approved oils from AVENTICS. Further information can be found in the "Technical information" document (available in <https://www.emerson.com/en-us/support>).

Rodless cylinders, Series RTC-BV

R480635629

RTC

2024-05-14

Dimensions in inches



S = stroke

Dimensions in inches

Piston Ø	Part No.	B	BU	CU	E	EE	FH	FR	FS
40 mm	R480676512	1.34	4.65	1.02	1.42	*10-32 UNF/M7	1.61	2.36	3.94
40 mm	R480671858	1.73	5.79	1.02	1.79	1/8 NPTF	1.99	1.57	3.94
40 mm	R480676497	2.28	6.42	1.57	2.03	1/8 NPTF	2.44	2.36	4.72
40 mm	R480608664	2.76	7.17	1.57	2.38	1/4 NPTF	2.8	2.36	4.72

Rodless cylinders, Series RTC-BV

R480635629

RTC

2024-05-14

Piston Ø	Part No.	B	BU	CU	E	EE	FH	FR	FS
40 mm	R480676501	3.62	8.07	1.57	2.66	1/4 NPTF	3.08	2.36	5.51
40 mm	R480676505	4.41	9.17	2.17	3.25	3/8 NPTF	3.67	3.94	7.09
40 mm	R480676498	5.51	10.59	2.17	4.07	3/8 NPTF	4.5	3.94	7.09

Piston Ø	GR	PL	PM	PO	PP	RT 1)	RU 2)	RX	SG
40 mm	0.79	0.85	0.35	13,1	0.52	M4	M4	8-36 UNF	0.68
40 mm	0.79	0.79	0.31	21,5	0.85	M5	M4	8-36 UNF	0.68
40 mm	1.18	0.73	0.37	24,5	0.96	M6	M6	1/4-20 UNC	0.87
40 mm	1.18	0.71	0.39	31,5	1.24	M6	M6	1/4-20 UNC	0.87
40 mm	1.18	0.63	0.63	35,5	1.4	M8	M6	1/4-20 UNC	0.87
40 mm	1.57	0.55	0.55	45,5	1.79	M8	M8	1/4-20 UNC	1.18
40 mm	1.57	0.55	0.55	59,5	2.34	M8	M8	1/4-20 UNC	1.18

Piston Ø	TG	W1	W2	W3	W4	W5	W6	W7	Wd1
40 mm	0.75	2.48	1.79	0.31	0.71	1.18	0.53	0.78	M6
40 mm	0.75	2.87	2.19	0.51	0.71	1.18	0.53	0.78	M6
40 mm	1.57	3.66	2.85	0.63	1.02	1.18	0.75	1.06	M8
40 mm	1.57	4.13	3.33	0.87	1.02	1.18	0.75	1.06	M8
40 mm	1.57	5.51	4.51	0.43	2.76	1.57	0.87	1.29	M12
40 mm	3.15	6.3	5.3	1.22	1.97	1.57	0.87	1.29	M12
40 mm	3.15	7.4	6.4	1.77	1.97	1.57	0.87	1.29	M12

Piston Ø	Wd2	ZZ	WH	ZD	Moving mass kg
40 mm	M6	2.68	2.5	7.36	0.17
40 mm	M6	2.73	3.44	8.46	0.35
40 mm	M8	3.22	3.54	9.45	0.71
40 mm	M8	3.68	4	10.35	1.08
40 mm	M12	4.29	4.61	9.82	1.61
40 mm	M12	5.06	4.59	13.12	2.29
40 mm	M12	5.61	5.14	14.21	4.71

Max. play and recommended max. lever arm length

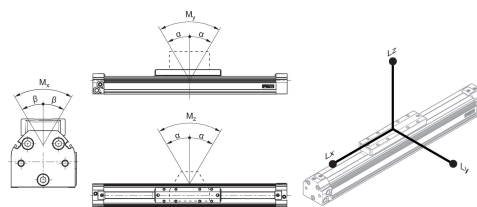

L = lever arm

M = moment (Nm)

Part No.	Piston Ø	Ø [inch]	α	β
R480676512	40 mm	5/8	0.5°	0.2°
R480671858	40 mm	1	0.5°	0.2°
R480676497	40 mm	1 1/4	0.6°	1.5°

Rodless cylinders, Series RTC-BV

R480635629

RTC

2024-05-14

Part No.	Piston Ø	Ø [inch]	α	β
R480608664	40 mm	1 1/2	0.4°	1.0°
R480676501	40 mm	2	0.4°	1.0°
R480676505	40 mm	2 1/2	0.3°	1.0°

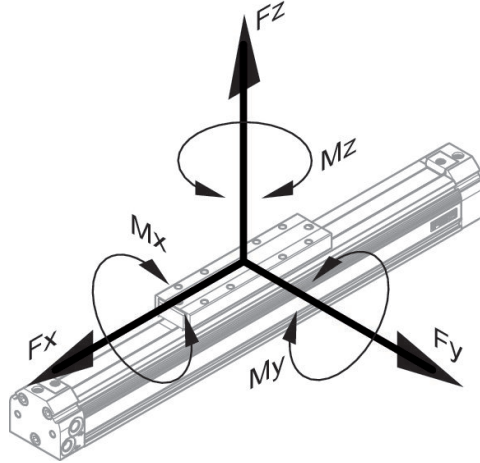

static

Part No.	Piston Ø	Ø [inch]	Fx [N]	Fy [N]	Fz [N]	Mx [Nm]	My [Nm]	Mz [Nm]
R480676512	40 mm	5/8	800	150	1100	2	25	8
R480671858	40 mm	1	1800	210	3800	6	50	12
R480676497	40 mm	1 1/4	2200	550	6600	18	80	43
R480608664	40 mm	1 1/2	3500	650	8000	28	140	55
R480676501	40 mm	2	5000	750	9000	35	230	70
R480676505	40 mm	2 1/2	6800	850	13000	45	340	90

dynamic

Part No.	Piston Ø	Ø [inch]	Mx [Nm]	My [Nm]	Mz [Nm]
R480676512	40 mm	5/8	0.42	10	2
R480671858	40 mm	1	1	24	3
R480676497	40 mm	1 1/4	3.8	42	12
R480608664	40 mm	1 1/2	6	75	15
R480676501	40 mm	2	9.1	128	20
R480676505	40 mm	2 1/2	14.5	195	24