

# Rodless cylinders, Series RTC-HD

R480156710

AVENTICS  
Series RTC  
Rodless  
cylinders

2024-04-22

## AVENTICS Series RTC Rodless cylinders

The AVENTICS Series RTC rodless cylinders offer optimized stroke length in a compact size. The unique oval piston shape and one-piece slide/piston unit are just two characteristic features of RTC Series rodless cylinders besides their many common equipment options. They are available in four variants: as a basic version, slide bearing, compact guide and heavy duty versions for large loads. With different key strengths, they cover a large range of movements and positions. This saves space and facilitates machine design. The range of applications extends from piston diameters of 16 mm up to 80 mm and stroke lengths up to 9900 mm. The cylinders feature extreme repeatability and cover a large speed range from 0.01 m/s to >20 m/s.



## Technical data

Industry	Industrial
Piston Ø	40 mm
Stroke	800 mm
Ports	G 1/4
Functional principle	Double-acting
Magnetic piston	with magnetic piston
Guide	ball rail guide
Version rodless cylinder	Heavy Duty
Easy2Combine	Easy2Combine capable with connection kit
Piston force	792 N
Pressure for determining piston forces	6,3 bar
Cushioning length	20 mm
Cushioning energy	10 J
Cushioning	Pneumatically
Cushioning	adjustable
Max. speed	2 m/s
Stroke max.	4300 mm
Min. working pressure	4 bar
Max. working pressure	8 bar

# Rodless cylinders, Series RTC-HD

R480156710

AVENTICS  
Series RTC  
Rodless  
cylinders

2024-04-22

Min. ambient temperature	-10 °C
Max. ambient temperature	60 °C
Medium	Compressed air
Min. oil content of compressed air	0 mg/m <sup>3</sup>
Max. oil content of compressed air	1 mg/m <sup>3</sup>
Max. particle size	5 µm
Weight 0 mm stroke	6.58 kg
Weight +10 mm stroke	0.128 kg

## Material

Material cylinder tube	Aluminum
Surface cylinder tube	anodized
Material front cover	Aluminum
Surface cover	anodized
Seal material	Polyurethane
Material sealing strips	Polyurethane Stainless Steel
Material guide rail	Aluminum
Surface ball rail table	anodized
Material guide rail	Steel, chrome-plated
Surface guide rail	hardened
Part No.	R480156710

## Technical information

The pressure dew point must be at least 15 °C less than ambient and medium temperature and may not exceed 3 °C.

The delivered product is lubricated for lifetime.

Use hydraulic shock absorbers for precise end position adjustment.

thread depth: 12 mm for piston Ø 16–25, 16 mm for piston Ø 32–40, 14 mm for piston Ø 50–63

thread depth: 12,7 mm for piston Ø 16–63 mm

thread depth: 9 mm for piston Ø 16–40 mm, 12 mm for piston Ø 50–63 mm

thread depth: 10 mm for piston Ø 16–63 mm

The pressure dew point must be at least 15 °C less than ambient and medium temperature and may not exceed 3 °C.

The oil content of compressed air must remain constant during the life cycle.

Use only the approved oils from AVENTICS. Further information can be found in the “Technical information” document (available in <https://www.emerson.com/en-us/support>).

# Rodless cylinders, Series RTC-HD

R480156710

Ø 16 ... 63 mm

AVENTICS  
Series RTC  
Rodless  
cylinders

2024-04-22

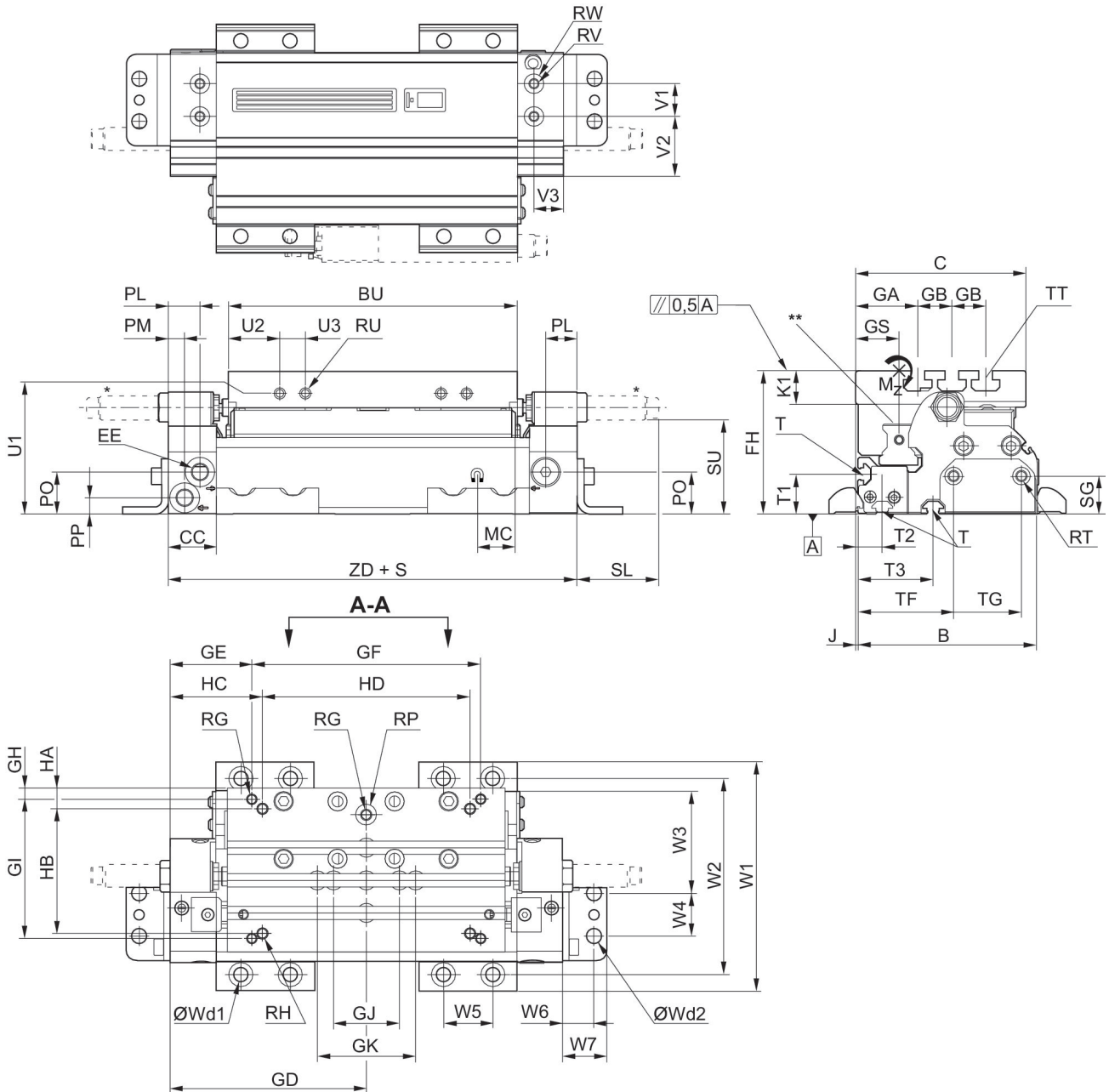

S = stroke

T = Type of t-groove nut

TT = Type of t-groove nut

\* Shock absorber optional in end cover for diameters 16-40

\*\* RTC-HD 16 & 25: funnel type lube nipple with thread M3, RTC-HD 32 - 63: lube nipple DIN 71412 with thread M6

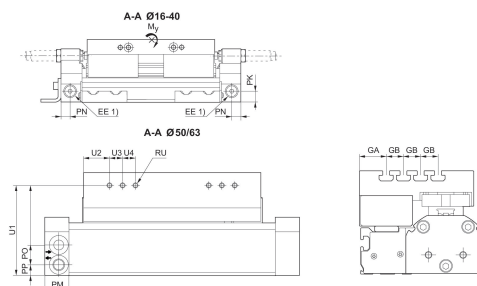

# Rodless cylinders, Series RTC-HD

R480156710

AVENTICS  
Series RTC  
Rodless  
cylinders

1) Auxiliary air feeding

An example configuration is illustrated. The delivered product may thus deviate from the illustration.

2024-04-22

Piston Ø	Part No.	B	C	BU	CC	EE	FH	GA	GB
40 mm	R480156949	82	82	122	28	M7	60	27	20
40 mm	R480149659	103	99.5	147	28	G 1/8	70	26	20
40 mm	R480154726	105	100	170	28	G 1/8	83.8	36.5	20
40 mm	R480155259	132	122	186	28	G 1/4	97.7	36.5	20
40 mm	R480155175	144.5	132.5	205	28	G 1/4	119.4	31	20
40 mm	R480156946	161	139	233	28	G 3/8	129.4	31	20

Piston Ø	GD	GE	GF	GH	GI	GJ	GK	GS	HA
40 mm	93.5	43.5	100	5	20/20/20	40	-	32	7.6
40 mm	107.5	52.5	110	16	20/40	40	-	37	6.4
40 mm	120	50	140	6.7	85	40	60	25.5	12.7
40 mm	131.5	46.5	170	12	100	40	60	31.5	12.7
40 mm	147.3	52.3	190	10	100	40	60	31.5	15.2
40 mm	166.5	71.5	190	10	100	40	60	31.5	15.2

Piston Ø	HB	HC	HD	J	K1	MC	PK	PL	PM
40 mm	69.9	55.4	76.2	1.5	20.7	12	11.9	18	7
40 mm	83.8	44	127	1.5	21.4	15	10.1	20	8
40 mm	76.2	56.5	127	1.5	19.7	20	15	18.5	9.5
40 mm	101.6	55.4	152.4	1.5	25.6	17	18	18	10
40 mm	99.06	66	162.6	1.5	28.6	23	N/A	16	16
40 mm	101.6	59.8	213.4	1.5	28.6	25	N/A	14	14

Piston Ø	PN	PO	PP	RG 1)	RH 2)	RP	RT 3)	RU 4)	RV
40 mm	7	13.3	7.3	M5	UNC 1/4-20	Ø 9	M5	M5	M5x8
40 mm	9	21.5	9.3	M5	UNC 1/4-20	Ø 9	M5	M6	M5x8
40 mm	12	24.5	9.5	M6	UNC 1/4-20	Ø 12	M6	M6	M6x10
40 mm	11	31.5	10.5	M6	UNC 1/4-20	Ø 12	M6	M6	M6x10
40 mm	N/A	35	12	M8	UNC 5/16-18	Ø 12	M8	M5	-
40 mm	N/A	45.5	14.5	M8	UNC 5/16-18	Ø 12	M8	M5	-

Piston Ø	RW	SG	SL	SU	T	TT	V1	V2	V3
40 mm	Ø 9H8x1,6	17.3	33.2	38.6	N4	N6	20	6	14
40 mm	Ø 9H8x1,6	17.3	49.3	47.1	N6	N6	20	26.5	18
40 mm	Ø 12H8x2,1	22	48.3	55.5	N6	N8	20	36.5	18
40 mm	Ø 12H8x2,1	22	45.1	73.4	N6	N8	20	40.5	18
40 mm	-	22	N/A	N/A	N8	N8	-	-	-
40 mm	-	30	N/A	N/A	N8	N8	-	-	-

Piston Ø	W1	W2	W3	W4	W5	W6	W7	Wd1	Wd2
40 mm	110.4	93.4	56	18	30	13.5	19.8	M6	M6
40 mm	131.4	114.4	72	18	30	16.5	19.8	M6	M6
40 mm	139.4	119.4	63	26	30	19	26.8	M8	M8

# Rodless cylinders, Series RTC-HD

R480156710

AVENTICS  
Series RTC  
Rodless  
cylinders

Piston Ø	W1	W2	W3	W4	W5	W6	W7	Wd1	Wd2
40 mm	166.4	146.4	84	26	30	19	26.8	M8	M8
40 mm	192.1	166.9	63.5	70	40	22	32.7	M12	M12
40 mm	208.6	183.4	80	50	40	22	32.7	M12	M12

Piston Ø	T1	T2	T3	TF	TG	U1	U2	U3	U4
40 mm	20.8	13.7	–	55.5	19	47	16.5	15	15
40 mm	20	14	54	71.5	19	60	18	21.5	15
40 mm	23	14	44	56	40	71	30	21	15
40 mm	24.7	29.5	59.5	77	40	82.7	30	29	15
40 mm	35.6	18.5	43.5	78.5	40	104.4	30	15	15
40 mm	45.6	17	39.5	65	80	114.4	30	15	15

Piston Ø	ZD	Moving mass kg
40 mm	187	0.64
40 mm	215	1.25
40 mm	240	1.4
40 mm	263.1	2.57
40 mm	294.6	3.19
40 mm	333	3.46

Max. play and recommended max. lever arm length

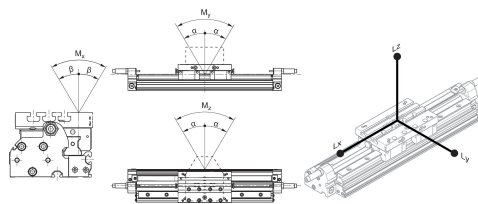

L = lever arm

M = moment (Nm)

Part No.	Piston Ø	$\alpha$	$\beta$	Lx	Ly	Lz
R480156949	40 mm	<0,1°	<0,2°	260	260	260
R480156950	40 mm	<0,1°	<0,2°	260	260	260
R480156951	40 mm	<0,1°	<0,2°	260	260	260
R480147724	40 mm	<0,1°	<0,2°	260	260	260
R480156953	40 mm	<0,1°	<0,2°	260	260	260
R480156954	40 mm	<0,1°	<0,2°	260	260	260
R480149659	40 mm	<0,1°	<0,2°	344	344	344
R480149553	40 mm	<0,1°	<0,2°	344	344	344
R480150759	40 mm	<0,1°	<0,2°	344	344	344
R480147725	40 mm	<0,1°	<0,2°	344	344	344
R480153574	40 mm	<0,1°	<0,2°	344	344	344
R480156959	40 mm	<0,1°	<0,2°	344	344	344
R480155572	40 mm	<0,1°	<0,2°	344	344	344
R480154726	40 mm	<0,1°	<0,2°	404	404	404

# Rodless cylinders, Series RTC-HD

R480156710

AVENTICS  
Series RTC  
Rodless  
cylinders

2024-04-22

Part No.	Piston Ø	$\alpha$	$\beta$	Lx	Ly	Lz
R480148820	40 mm	<0,1°	<0,2°	404	404	404
R480148602	40 mm	<0,1°	<0,2°	404	404	404
R480147726	40 mm	<0,1°	<0,2°	404	404	404
R480148603	40 mm	<0,1°	<0,2°	404	404	404
R480154001	40 mm	<0,1°	<0,2°	404	404	404
R480150325	40 mm	<0,1°	<0,2°	404	404	404
R480156963	40 mm	<0,1°	<0,2°	404	404	404
R480148582	40 mm	<0,1°	<0,2°	404	404	404
R480155259	40 mm	<0,1°	<0,2°	440	440	440
R480154424	40 mm	<0,1°	<0,2°	440	440	440
R480154425	40 mm	<0,1°	<0,2°	440	440	440
R480147727	40 mm	<0,1°	<0,2°	440	440	440
R480148971	40 mm	<0,1°	<0,2°	440	440	440
R480149554	40 mm	<0,1°	<0,2°	440	440	440
R480156710	40 mm	<0,1°	<0,2°	440	440	440
R480156969	40 mm	<0,1°	<0,2°	440	440	440
R480150515	40 mm	<0,1°	<0,2°	440	440	440
R480155175	40 mm	<0,1°	<0,2°	532	532	532
R480147728	40 mm	<0,1°	<0,2°	532	532	532
R480146987	40 mm	<0,1°	<0,2°	532	532	532
R480156943	40 mm	<0,1°	<0,2°	532	532	532
R480149774	40 mm	<0,1°	<0,2°	532	532	532
R480156944	40 mm	<0,1°	<0,2°	532	532	532
R480149030	40 mm	<0,1°	<0,2°	532	532	532
R480156946	40 mm	<0,1°	<0,2°	644	644	644
R480147729	40 mm	<0,1°	<0,2°	644	644	644
R480156947	40 mm	<0,1°	<0,2°	644	644	644
R480149638	40 mm	<0,1°	<0,2°	644	644	644
R480154379	40 mm	<0,1°	<0,2°	644	644	644
R480149592	40 mm	<0,1°	<0,2°	644	644	644

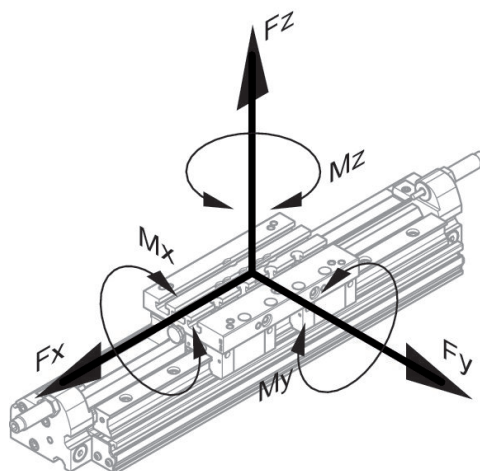

# Rodless cylinders, Series RTC-HD

R480156710

AVENTICS  
Series RTC  
Rodless  
cylinders

2024-04-22

## static

Part No.	Piston Ø	Fx [N]	Fy [N]	Fz [N]	Mx [Nm]	My [Nm]	Mz [Nm]
R480156949	40 mm	1640	1640	4284	34	138	53
R480156950	40 mm	1640	1640	4284	34	138	53
R480156951	40 mm	1640	1640	4284	34	138	53
R480147724	40 mm	1640	1640	4284	34	138	53
R480156953	40 mm	1640	1640	4284	34	138	53
R480156954	40 mm	1640	1640	4284	34	138	53
R480149659	40 mm	2640	2640	7810	100	336	114
R480149553	40 mm	2640	2640	7810	100	336	114
R480150759	40 mm	2640	2640	7810	100	336	114
R480147725	40 mm	2640	2640	7810	100	336	114
R480153574	40 mm	2640	2640	7810	100	336	114
R480156959	40 mm	2640	2640	7810	100	336	114
R480155572	40 mm	2640	2640	7810	100	336	114
R480154726	40 mm	3760	3760	9952	154	502	190
R480148820	40 mm	3760	3760	9952	154	502	190
R480148602	40 mm	3760	3760	9952	154	502	190
R480147726	40 mm	3760	3760	9952	154	502	190
R480148603	40 mm	3760	3760	9952	154	502	190
R480154001	40 mm	3760	3760	9952	154	502	190
R480150325	40 mm	3760	3760	9952	154	502	190
R480156963	40 mm	3760	3760	9952	154	502	190
R480148582	40 mm	3760	3760	9952	154	502	190
R480155259	40 mm	6840	6840	13922	254	764	376
R480154424	40 mm	6840	6840	13922	254	764	376
R480154425	40 mm	6840	6840	13922	254	764	376
R480147727	40 mm	6840	6840	13922	254	764	376
R480148971	40 mm	6840	6840	13922	254	764	376
R480149554	40 mm	6840	6840	13922	254	764	376
R480156710	40 mm	6840	6840	13922	254	764	376
R480156969	40 mm	6840	6840	13922	254	764	376
R480150515	40 mm	6840	6840	13922	254	764	376
R480155175	40 mm	6840	6840	13922	254	924	455
R480147728	40 mm	6840	6840	13922	254	924	455
R480146987	40 mm	6840	6840	13922	254	924	455
R480156943	40 mm	6840	6840	13922	254	924	455
R480149774	40 mm	6840	6840	13922	254	924	455
R480156944	40 mm	6840	6840	13922	254	924	455
R480149030	40 mm	6840	6840	13922	254	924	455
R480156946	40 mm	6840	6840	13922	254	1120	551
R480147729	40 mm	6840	6840	13922	254	1120	551
R480156947	40 mm	6840	6840	13922	254	1120	551
R480149638	40 mm	6840	6840	13922	254	1120	551

# Rodless cylinders, Series RTC-HD

R480156710

AVENTICS  
Series RTC  
Rodless  
cylinders

2024-04-22

Part No.	Piston Ø	Fx [N]	Fy [N]	Fz [N]	Mx [Nm]	My [Nm]	Mz [Nm]
R480154379	40 mm	6840	6840	13922	254	1120	551
R480149592	40 mm	6840	6840	13922	254	1120	551

## dynamic

Part No.	Piston Ø	Mx [Nm]	My [Nm]	Mz [Nm]
R480156949	40 mm	34	138	53
R480156950	40 mm	34	138	53
R480156951	40 mm	34	138	53
R480147724	40 mm	34	138	53
R480156953	40 mm	34	138	53
R480156954	40 mm	34	138	53
R480149659	40 mm	100	336	114
R480149553	40 mm	100	336	114
R480150759	40 mm	100	336	114
R480147725	40 mm	100	336	114
R480153574	40 mm	100	336	114
R480156959	40 mm	100	336	114
R480155572	40 mm	100	336	114
R480154726	40 mm	154	502	190
R480148820	40 mm	154	502	190
R480148602	40 mm	154	502	190
R480147726	40 mm	154	502	190
R480148603	40 mm	154	502	190
R480154001	40 mm	154	502	190
R480150325	40 mm	154	502	190
R480156963	40 mm	154	502	190
R480148582	40 mm	154	502	190
R480155259	40 mm	254	764	376
R480154424	40 mm	254	764	376
R480154425	40 mm	254	764	376
R480147727	40 mm	254	764	376
R480148971	40 mm	254	764	376
R480149554	40 mm	254	764	376
R480156710	40 mm	254	764	376
R480156969	40 mm	254	764	376
R480150515	40 mm	254	764	376
R480155175	40 mm	254	924	455
R480147728	40 mm	254	924	455
R480146987	40 mm	254	924	455
R480156943	40 mm	254	924	455
R480149774	40 mm	254	924	455
R480156944	40 mm	254	924	455
R480149030	40 mm	254	924	455
R480156946	40 mm	254	1120	551



# Rodless cylinders, Series RTC-HD

R480156710

AVENTICS  
Series RTC  
Rodless  
cylinders

2024-04-22

Part No.	Piston Ø	Mx [Nm]	My [Nm]	Mz [Nm]
R480147729	40 mm	254	1120	551
R480156947	40 mm	254	1120	551
R480149638	40 mm	254	1120	551
R480154379	40 mm	254	1120	551
R480149592	40 mm	254	1120	551