

Rodless cylinders, Series RTC-BV

R481608205

AVENTICS
Series RTC
Rodless
cylinders

2024-04-22

AVENTICS Series RTC Rodless cylinders

The AVENTICS Series RTC rodless cylinders offer optimized stroke length in a compact size. The unique oval piston shape and one-piece slide/piston unit are just two characteristic features of RTC Series rodless cylinders besides their many common equipment options. They are available in four variants: as a basic version, slide bearing, compact guide and heavy duty versions for large loads. With different key strengths, they cover a large range of movements and positions. This saves space and facilitates machine design. The range of applications extends from piston diameters of 16 mm up to 80 mm and stroke lengths up to 9900 mm. The cylinders feature extreme repeatability and cover a large speed range from 0.01 m/s to >20 m/s.



Technical data

Industry	Industrial
Piston Ø	63 mm
Stroke	500 mm
Ports	G 3/8
Functional principle	Double-acting
Magnetic piston	with magnetic piston
Guide	integrated guide
Version rodless cylinder	Basic Version
Piston force	1964 N
Pressure for determining piston forces	6,3 bar
Cushioning length	20 mm
Cushioning energy	25 J
Cushioning	Pneumatically
Cushioning	adjustable
Max. speed	0.8 m/s
Stroke max.	5800 mm
Min. working pressure	2 bar
Max. working pressure	8 bar
Min. ambient temperature	-25 °C

Rodless cylinders, Series RTC-BV

R481608205

AVENTICS
Series RTC
Rodless
cylinders

2024-04-22

Max. ambient temperature	60 °C
Medium	Compressed air
Min. oil content of compressed air	0 mg/m ³
Max. oil content of compressed air	1 mg/m ³
Max. particle size	5 µm
Weight 0 mm stroke	1.39 kg
Weight +10 mm stroke	0.031 kg

Material

Material cylinder tube	Aluminum
Surface cylinder tube	anodized
Material front cover	Aluminum
Surface cover	anodized
Seal material	Polyurethane
Material sealing strips	Polyurethane Stainless Steel
Material guide rail	Aluminum
Surface ball rail table	anodized
Part No.	R481608205

Technical information

The pressure dew point must be at least 15 °C less than ambient and medium temperature and may not exceed 3 °C.

The delivered product is lubricated for lifetime.

Further dimensions, referring to more than just the long slide, can be found in the section on the basic version of the RTC-BV.

The pressure dew point must be at least 15 °C less than ambient and medium temperature and may not exceed 3 °C.

The oil content of compressed air must remain constant during the life cycle.

Use only the approved oils from AVENTICS. Further information can be found in the "Technical information" document (available in <https://www.emerson.com/en-us/support>).

Rodless cylinders, Series RTC-BV

R481608205

AVENTICS
Series RTC
Rodless
cylinders

2024-04-22

Dimensions in mm

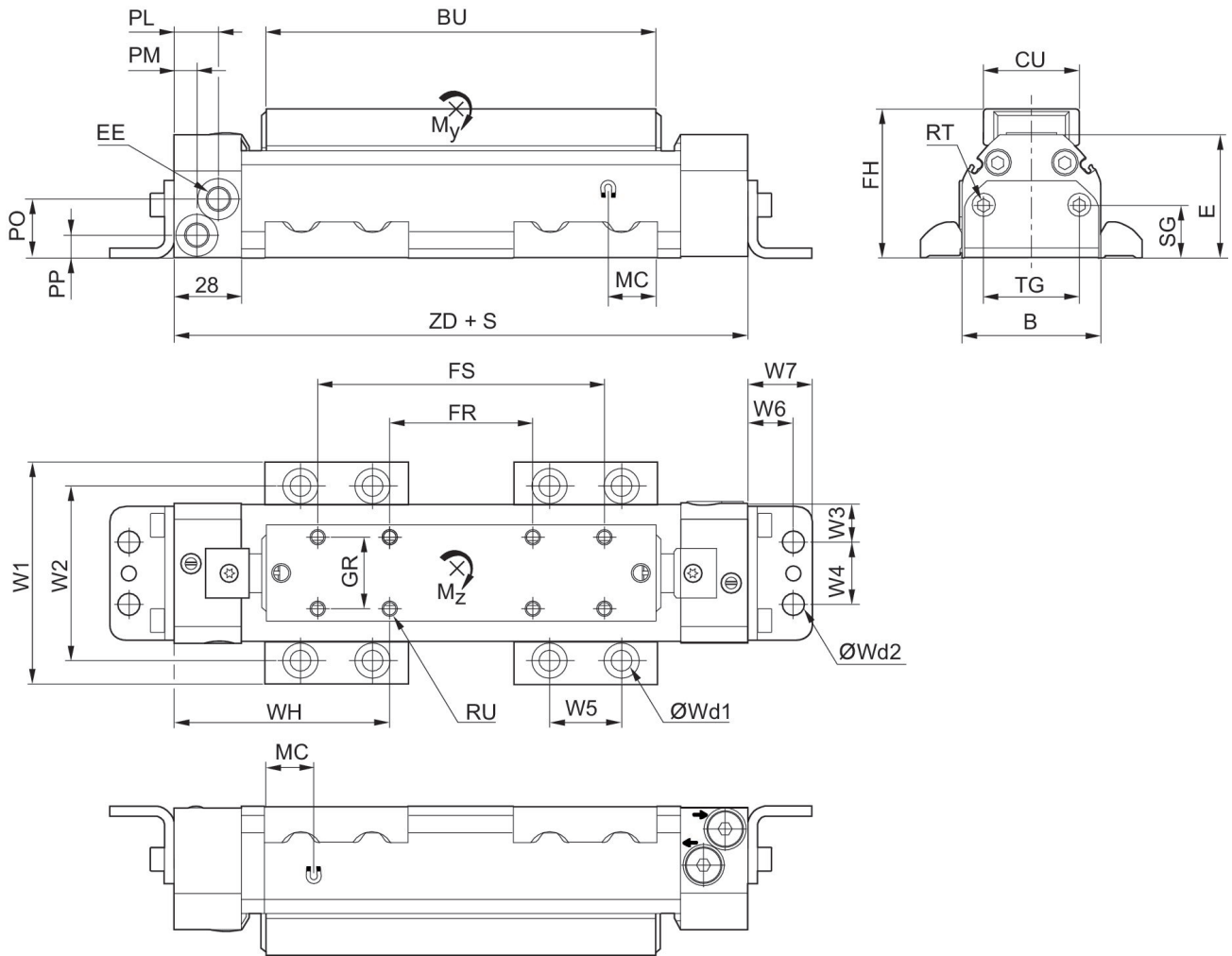

S = stroke

Piston \varnothing	Part No.	B	BU	CU	E	EE	FH	FR	FS
63 mm	R481608171	58	163	40	51.5	G 1/8	62.1	60	120
63 mm	R481608181	70	182	40	60.5	G 1/4	71.1	60	120
63 mm	R481608191	92	205	40	67.5	G 1/4	78.3	60	140
63 mm	R481608201	112	233	55	82.5	G 3/8	93.3	100	180
63 mm	R481608211	140	269	55	103.5	G 3/8	114.2	100	180

Piston \varnothing	GR	MC	PL	PM	PO	PP	RT 1)	RU 2)	SG
63 mm	30	20	18.5	9.5	24.5	9.5	M6	M6	22
63 mm	30	17	18	10	31.5	11	M6	M6	22
63 mm	30	23	16	16	35.5	12.5	M8	M6	22
63 mm	40	25	14	14	45.5	14.5	M8	M8	30
63 mm	40	27	14	14	59.5	16.5	M8	M8	30

Rodless cylinders, Series RTC-BV

R481608205

AVENTICS
Series RTC
Rodless
cylinders

Piston Ø	TG	W1	W2	W3	W4	W5	W6	W7	Wd1
63 mm	40	93	72.5	16	26	30	19	26.8	M8
63 mm	40	105	84.5	22	26	30	19	26.8	M8
63 mm	40	140	114.5	11	70	40	22	32.7	M12
63 mm	80	160	134.5	31	50	40	22	32.7	M12
63 mm	80	188	162.5	45	50	40	22	32.7	M12

Piston Ø	Wd2	WH	ZD	Moving mass kg
63 mm	M8	90	240	0.32
63 mm	M8	101.5	263	0.49
63 mm	M12	117.1	294.2	0.73
63 mm	M12	116.5	333.2	1.31
63 mm	M12	130.5	361	2.14

1) thread depth: 6 mm for piston Ø 16–25 mm, 10 mm for piston Ø 32–50 mm, 15 mm for piston Ø 63–80 mm

2) thread depth: 9 mm for piston Ø 16–40 mm, 12 mm for piston Ø 50–63 mm

Permissible parallelism offset

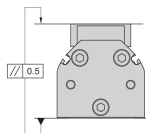

Permissible forces Fx, Fy, Fz and torques Mx, My, Mz

$$\frac{M_x}{M_{x_{max.}}} + \frac{M_y}{M_{y_{max.}}} + \frac{M_z}{M_{z_{max.}}} \leq 1$$

With simultaneously moments on the cylinder this equation must be used in addition to the maximum moments check. In the cushioning phase of the movement additional forces occur and must be considered. Please use our calculation tool for rodless cylinders on the <http://www.aventics.com>.

Support span

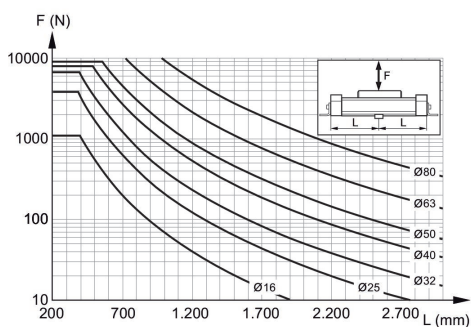

Max. support span L [mm] as a function of F [N] at a deflection of 0.5 mm

Limit diagram for pneumatic cushioning with horizontal mounting

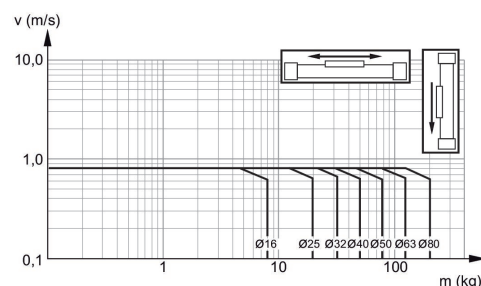

v_t = Piston velocity [m/s] m = Cushionable mass [kg]

The values for the cushionable mass m and piston velocity v must be on or below the graph for the selected piston diameter.

Rodless cylinders, Series RTC-BV

R481608205

AVENTICS
Series RTC
Rodless
cylinders

2024-04-22

Limit diagram for pneumatic cushioning with vertical mounting

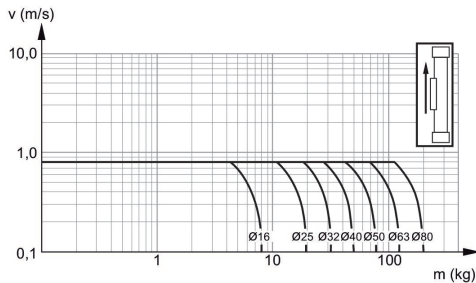

v_t = Piston velocity [m/s] m = Cushionable mass [kg]

The values for the cushionable mass m and piston velocity v must be on or below the graph for the selected piston diameter.

For long slide

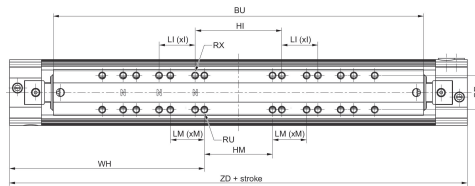

S = stroke

Piston Ø	Part No.	BU	GR	HI	LI	(xI)	HM	LM	(xM)
63 mm	R481608171	326	30	76.2	31.75	2	60	30	3
63 mm	R481608181	364	30	76.2	31.75	3	60	30	4
63 mm	R481608191	410	30	76.2	31.75	3	60	40	3
63 mm	R481608201	466	40	152.4	38.1	2	100	40	3
63 mm	R481608211	538	40	152.4	38.1	3	100	40	4

Piston Ø	RU	RX	WH	ZD
63 mm	M6	1/4-20 UNC	171.5	403
63 mm	M6	1/4-20 UNC	192.5	445
63 mm	M6	1/4-20 UNC	219.6	499.2
63 mm	M8	5/16-18 UNC	233	566.2
63 mm	M8	5/16-18 UNC	265	630

Rodless cylinders, Series RTC-BV

R481608205

AVENTICS
Series RTC
Rodless
cylinders

2024-04-22

Weight [kg]

\varnothing	Weight 0 mm stroke	+10 mm stroke
32	2.31	0.031
40	3.5	0.044
50	5.57	0.065
63	9.4	0.098

Max. play and recommended max. lever arm length

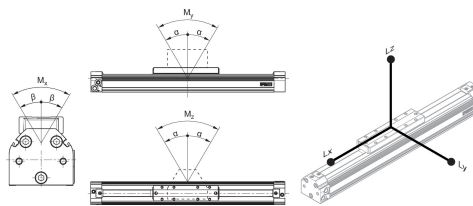

L = lever arm

M = moment (Nm)

For long slide

Part No.	Piston \varnothing	α	β	Lx	Ly	Lz
R481608171	63 mm	0,3°	1,5° ±0,5°	480	278	480
R481608181	63 mm	0,2°	1,0° ±0,3°	550	316	550
R481608191	63 mm	0,2°	1,0° ±0,3°	634	362	634
R481608201	63 mm	0,15°	1,0° ±0,3°	736	418	736

Max. play and recommended max. lever arm length

Part No.	Piston \varnothing	α	β	Lx	Ly	Lz
R481608171	63 mm	0,6°	1,5° ±0,5°	240	139	240
R481608181	63 mm	0,4°	1,0° ±0,3°	275	158	275
R481608191	63 mm	0,4°	1,0° ±0,3°	317	181	317
R481608201	63 mm	0,3°	1,0° ±0,3°	368	209	368

Rodless cylinders, Series RTC-BV

R481608205

AVENTICS
Series RTC
Rodless
cylinders

2024-04-22

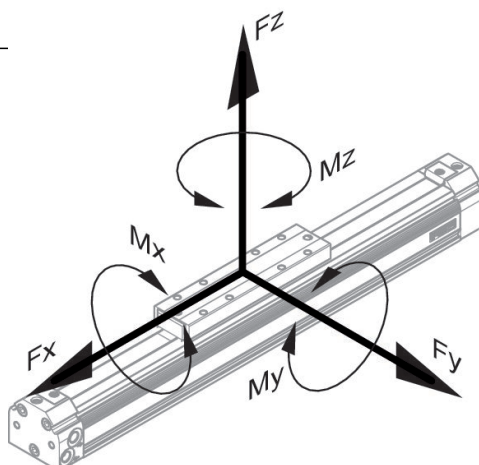

static, for long slide

Part No.	Piston Ø	Fx [N]	Fy [N]	Fz [N]	Mx [Nm]	My [Nm]	Mz [Nm]
R481608171	63 mm	2200	550	6600	36	160	86
R481608181	63 mm	3500	650	8000	56	280	110
R481608191	63 mm	5000	750	9000	70	460	140
R481608201	63 mm	6800	850	13000	90	680	180

dynamic, for long slide

Part No.	Piston Ø	Mx [Nm]	My [Nm]	Mz [Nm]
R481608171	63 mm	4	84	24
R481608181	63 mm	6	150	30
R481608191	63 mm	9	256	40
R481608201	63 mm	15	390	48

static

Part No.	Piston Ø	Fx [N]	Fy [N]	Fz [N]	Mx [Nm]	My [Nm]	Mz [Nm]
R481608171	63 mm	2200	550	6600	18	80	43
R481608181	63 mm	3500	650	8000	28	140	55
R481608191	63 mm	5000	750	9000	35	230	70
R481608201	63 mm	6800	850	13000	45	340	90

Rodless cylinders, Series RTC-BV

R481608205

AVENTICS
Series RTC
Rodless
cylinders

2024-04-22

dynamic

Part No.	Piston Ø	Mx [Nm]	My [Nm]	Mz [Nm]
R481608171	63 mm	4	42	12
R481608181	63 mm	6	75	15
R481608191	63 mm	9	128	20
R481608201	63 mm	15	195	24