

AVENTICS Series RTC Rodless cylinders

The AVENTICS Series RTC rodless cylinders offer optimized stroke length in a compact size. The unique oval piston shape and one-piece slide/piston unit are just two characteristic features of RTC Series rodless cylinders besides their many common equipment options. They are available in four variants: as a basic version, slide bearing, compact guide and heavy duty versions for large loads. With different key strengths, they cover a large range of movements and positions. This saves space and facilitates machine design. The range of applications extends from piston diameters of 16 mm up to 80 mm and stroke lengths up to 9900 mm. The cylinders feature extreme repeatability and cover a large speed range from 0.01 m/s to >20 m/s.



Technical data

Industry	Industrial
Piston Ø	63 mm
Stroke	1371.6 mm
Functional principle	Double-acting
Magnetic piston	with magnetic piston
Guide	ball rail guide
Version rodless cylinder	Heavy Duty
Easy2Combine	Easy2Combine capable with connection kit
Piston force	1964 N
Pressure for determining piston forces	6,3 bar
Cushioning length	20 mm
Cushioning energy	25 J
Cushioning	Pneumatically
Cushioning	adjustable
Max. speed	2 m/s
Stroke max.	4300 mm
Min. working pressure	4 bar
Max. working pressure	8 bar
Min. ambient temperature	-10 °C

Max. ambient temperature	60 °C
Medium	Compressed air
Min. oil content of compressed air	0 mg/m ³
Max. oil content of compressed air	1 mg/m ³
Max. particle size	5 µm
Weight 0 mm stroke	11.75 kg
Weight +10 mm stroke	0.193 kg

Material

Material cylinder tube	Aluminum
Surface cylinder tube	anodized
Material front cover	Aluminum
Surface cover	anodized
Seal material	Polyurethane
Material sealing strips	Polyurethane Stainless Steel
Material guide rail	Aluminum
Surface ball rail table	anodized
Material guide rail	Steel, chrome-plated
Surface guide rail	hardened
Part No.	R480676534

Technical information

The pressure dew point must be at least 15 °C less than ambient and medium temperature and may not exceed 3 °C.

The delivered product is lubricated for lifetime.

Use hydraulic shock absorbers for precise end position adjustment.

These pneumatic components with NPT or inch thread dimensions are only available from our US sales organization.

Thread depth: 0.47 inch for piston Ø 5/8 - 1, 0.63 inch for piston Ø 5/8 - 1 1/2, 0.55 inch for piston Ø 5/8 - 3

Thread depth: 0.50 inch for piston Ø 5/8 - 3

Thread depth: 0.35 inch for piston Ø 5/8 - 1 1/2, 0.47 inch for piston Ø 5/8 - 3

Thread depth: 0.40 inch for piston Ø 5/8 - 3

Can be selected in the configurator (M7 for high-speed applications)

The pressure dew point must be at least 15 °C less than ambient and medium temperature and may not exceed 3 °C.

The oil content of compressed air must remain constant during the life cycle.

Use only the approved oils from AVENTICS. Further information can be found in the "Technical information" document (available in <https://www.emerson.com/en-us/support>).

Rodless cylinders, Series RTC-HD

R480676534

RTC

2024-05-14

Dimensions in inches



S = stroke

T = Type of t-groove nut

TT = Type of t-groove nut

* Shock absorber optional in end cover for diameters 16-40

** RTC-HD 16 & 25: funnel type lube nipple with thread M3, RTC-HD 32 - 63: lube nipple DIN 71412 with thread M6

Dimensions in inches

Piston Ø	Part No.	Ø [inch]	B	C	BU	CC	EE	EF	EG
63 mm	R480676537	1	4.6	3.92	5.79	1.1	1/8 NPTF	-	-
63 mm	R480676527	1 1/4	4.13	3.94	6.69	1.1	1/8 NPTF	-	-
63 mm	R480676548	1 1/2	5.2	4.8	7.32	1.1	1/4 NPTF	-	-

Rodless cylinders, Series RTC-HD

R480676534

RTC

2024-05-14

Piston Ø	Part No.	Ø [inch]	B	C	BU	CC	EE	EF	EG
63 mm	R480636524	2	5.69	5.22	8.07	1.1	1/4 NPTF	Ø 4,59	Ø 0,91
63 mm	R480676533	2 1/2	6.34	5.47	9.17	1.1	3/8 NPTF	Ø 0,59	Ø 1,04

Piston Ø	FH	GA	GB	GD	GE	GF	GH	GI	GJ
63 mm	2.76	1.02	0.79	4.23	4.23	4.33	0.63	20/40	1.57
63 mm	3.3	1.44	0.79	4.72	4.72	5.51	0.26	85	1.57
63 mm	3.85	1.44	0.79	5.18	5.18	6.69	0.47	100	1.57
63 mm	4.7	1.22	0.79	5.8	5.8	7.48	0.39	100	1.57
63 mm	5.09	1.22	0.79	6.56	6.56	7.48	0.39	100	1.57

Piston Ø	GK	GS	HA	HB	HC	HD	J	K1	MC
63 mm	–	1.46	0,25	3,3	1,732	5	0.06	0.84	0.59
63 mm	2.36	1	0,5	3	2,224	5	0.06	0.78	0.79
63 mm	2.36	1.24	0,5	4	2,181	6	0.06	1.01	0.67
63 mm	2.36	1.24	0,6	3,9	2,598	6.4	0.06	1.3	0.91
63 mm	2.36	1.24	0,6	4	2,354	8.4	0.06	1.3	0.98

Piston Ø	PK	PL	PM	PN	PO	PP	PR	PQ	RG 1)
63 mm	0.4	0.79	0.31	0.35	0.85	0.37	–	–	M5
63 mm	0.59	0.73	0.37	0.47	0.96	0.37	–	–	M6
63 mm	0.71	0.71	0.39	0.43	1.24	0.41	–	–	M6
63 mm	–	0.63	0.63	–	1.38	0.47	0.84	1.22	M8
63 mm	–	0.55	0.55	–	1.79	0.57	1.06	0.98	M8

Piston Ø	RH 2)	RP	RQ	RT 3)	RU 4)	SG	SL	SU	T
63 mm	4xUNC 1/4-20	Ø 9	M6	M5	M6	0.68	1.94	1.85	N6
63 mm	4xUNC 1/4-20	Ø 12	M6	M6	M6	0.87	1.9	2.19	N6
63 mm	4xUNC 1/4-20	Ø 12	M8	M6	M6	0.87	1.78	2.89	N6
63 mm	4xUNC 5/16-18	Ø 12	M8	M8	M5	0.87	–	–	N8
63 mm	4xUNC 5/16-18	Ø 12	M8	M8	M5	1.18	–	–	N8

Piston Ø	TT	W1	W2	W3	W4	W5	W6	W7	Wd1
63 mm	N6	5.17	4.5	2.83	0.71	0.05	0.53	0.78	M6
63 mm	N8	5.49	4.7	2.48	1.02	0.05	0.75	1.06	M8
63 mm	N8	6.55	5.76	3.31	1.02	0.05	0.75	1.06	M8
63 mm	N8	7.56	6.57	2.5	2.76	0.06	0.87	1.29	M12
63 mm	N8	8.21	7.22	3.15	1.97	0.06	0.87	1.29	M12

Piston Ø	Wd2	T1	T2	T3	TF	TG	U1	U2	U3
63 mm	M6	0.79	0.55	2.13	2.81	0.75	2.24	0,7	0.85
63 mm	M8	0.91	0.55	1.73	2.2	1.57	2.8	1.18	0,83
63 mm	M8	0.97	1.16	2.34	3.03	1.57	3.26	1.18	1,14
63 mm	M12	1.4	0.73	1.71	3.09	1.57	4,1	1.18	0.59
63 mm	M12	1.8	0.67	1.56	2.56	3.15	4.5	1.18	0.59

Piston Ø	U4	ZD	Moving mass [lbs]
63 mm	0.59	8.46	2.75
63 mm	0.59	9.45	3.09
63 mm	0.59	9.3	5.67
63 mm	0.59	11.6	7.03
63 mm	0.59	13.11	7.63

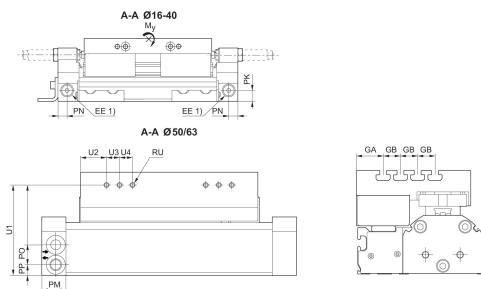

Permissible forces F_x, F_y, F_z and torques M_x, M_y, M_z

$$\frac{M_x}{M_{x_{max}}} + \frac{M_y}{M_{y_{max}}} + \frac{M_z}{M_{z_{max}}} \leq 1$$

With simultaneously moments on the cylinder this equation must be used in addition to the maximum moments check. In the cushioning phase of the movement additional forces occur and must be considered. Please use our calculation tool for rodless cylinders on the <http://www.aventics.com>.

1) Auxiliary air feeding

An example configuration is illustrated. The delivered product may thus deviate from the illustration.

Limit diagram for pneumatic cushioning for horizontal or vertical mounting

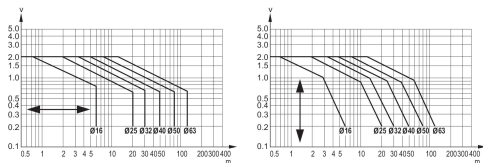

v_t = Piston velocity [m/s] m = Cushionable mass [kg]

The values for the cushionable mass m and piston velocity v must be on or below the graph for the selected piston diameter.

Support span

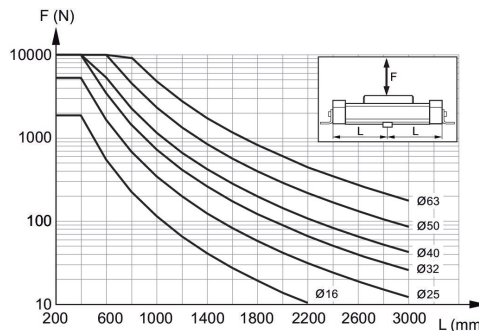

Max. support span L [mm] as a function of F [N] at a deflection of 0.5 mm

Max. play and recommended max. lever arm length

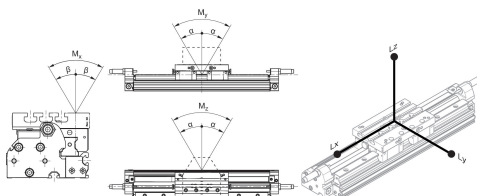

L = lever arm

M = moment (Nm)

Rodless cylinders, Series RTC-HD

R480676534

RTC

2024-05-14

Part No.	Piston Ø	Ø [inch]	α	β	Lx	Ly	Lz
R480676537	63 mm	1	<0,1°	<0,2°	344	344	344
R480676527	63 mm	1 1/4	<0,1°	<0,2°	404	404	404
R480676548	63 mm	1 1/2	<0,1°	<0,2°	440	440	440
R480636524	63 mm	2	<0,1°	<0,2°	532	532	532

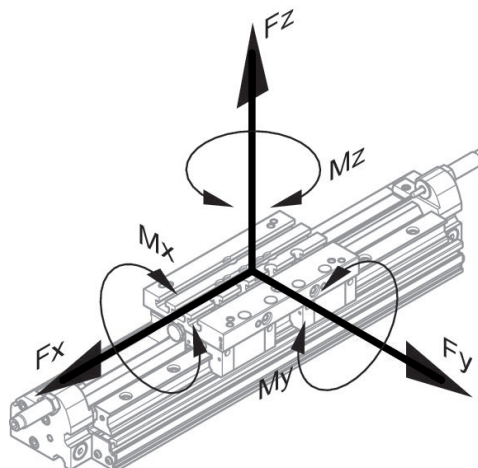

static

Part No.	Piston Ø	Ø [inch]	Fx [N]	Fy [N]	Fz [N]	Mx [Nm]	My [Nm]	Mz [Nm]
R480676537	63 mm	1	2640	2640	7810	100	336	114
R480676527	63 mm	1 1/4	3760	3760	9952	154	502	190
R480676548	63 mm	1 1/2	6840	6840	13922	254	764	376
R480636524	63 mm	2	6840	6840	13922	254	924	455

dynamic

Part No.	Piston Ø	Ø [inch]	Mx [Nm]	My [Nm]	Mz [Nm]
R480676537	63 mm	1	100	336	114
R480676527	63 mm	1 1/4	154	502	190
R480676548	63 mm	1 1/2	254	764	376
R480636524	63 mm	2	254	924	455