

Rodless cylinders, Series RTC-BV

R480155522

AVENTICS
Series RTC
Rodless
cylinders

2024-04-22

AVENTICS Series RTC Rodless cylinders

The AVENTICS Series RTC rodless cylinders offer optimized stroke length in a compact size. The unique oval piston shape and one-piece slide/piston unit are just two characteristic features of RTC Series rodless cylinders besides their many common equipment options. They are available in four variants: as a basic version, slide bearing, compact guide and heavy duty versions for large loads. With different key strengths, they cover a large range of movements and positions. This saves space and facilitates machine design. The range of applications extends from piston diameters of 16 mm up to 80 mm and stroke lengths up to 9900 mm. The cylinders feature extreme repeatability and cover a large speed range from 0.01 m/s to >20 m/s.



Technical data

Industry	Industrial
Piston Ø	80 mm
Stroke	700 mm
Ports	G 3/8
Functional principle	Double-acting
Magnetic piston	with magnetic piston
Guide	integrated guide
Version rodless cylinder	Basic Version
Piston force	3146 N
Pressure for determining piston forces	6,3 bar
Cushioning length	20 mm
Cushioning energy	40 J
Cushioning	Pneumatically
Cushioning	adjustable
Max. speed	3 m/s
Stroke max.	4800 mm
Min. working pressure	2 bar
Max. working pressure	8 bar
Min. ambient temperature	-10 °C

Rodless cylinders, Series RTC-BV

R480155522

AVENTICS
Series RTC
Rodless
cylinders

2024-04-22

Max. ambient temperature	60 °C
Medium	Compressed air
Min. oil content of compressed air	0 mg/m ³
Max. oil content of compressed air	1 mg/m ³
Max. particle size	5 µm
Weight 0 mm stroke	9.71 kg
Weight +10 mm stroke	0.157 kg

Material

Material cylinder tube	Aluminum
Surface cylinder tube	anodized
Material front cover	Aluminum
Surface cover	anodized
Seal material	Polyurethane
Material sealing strips	Polyurethane Stainless Steel
Material guide rail	Aluminum
Surface ball rail table	anodized
Part No.	R480155522

Technical information

The pressure dew point must be at least 15 °C less than ambient and medium temperature and may not exceed 3 °C.

The delivered product is lubricated for lifetime.

thread depth: 9 mm for piston Ø 16–40 mm, 12 mm for piston Ø 50–63 mm

thread depth: 6 mm for piston Ø 16–25 mm, 10 mm for piston Ø 32–50 mm, 15 mm for piston Ø 63–80 mm

Further dimensions, referring to more than just the long slide, can be found in the section on the basic version of the RTC-BV.

No second row for 1/4-20 UNC connections

The pressure dew point must be at least 15 °C less than ambient and medium temperature and may not exceed 3 °C.

The oil content of compressed air must remain constant during the life cycle.

Use only the approved oils from AVENTICS. Further information can be found in the “Technical information” document (available in <https://www.emerson.com/en-us/support>).

Rodless cylinders, Series RTC-BV

R480155522

AVENTICS
Series RTC
Rodless
cylinders

2024-04-22

Dimensions in mm

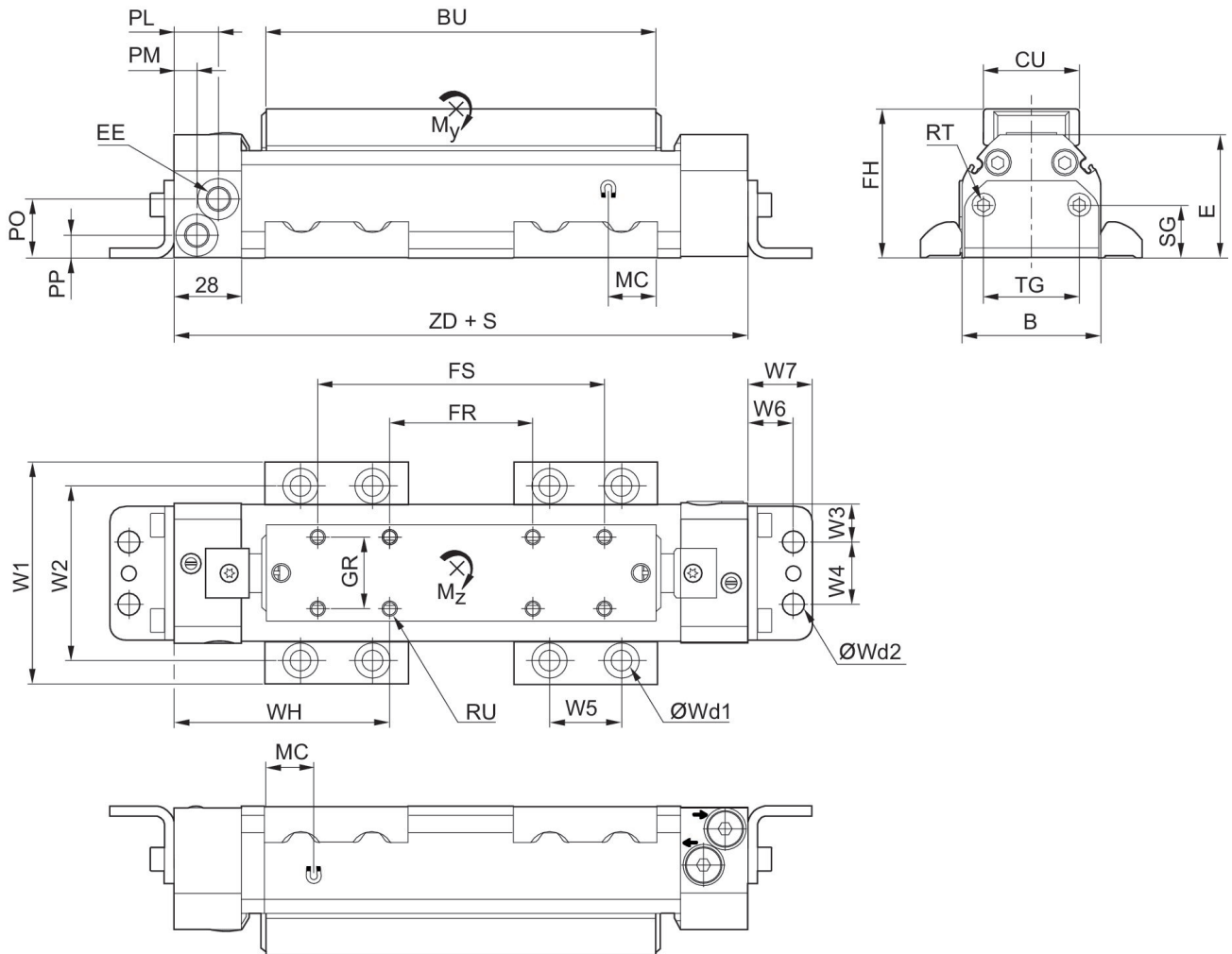

S = stroke

Piston \varnothing	B	BU	CU	E	EE	FH	FR	FS	GR
16	34	118	26	36	M7	41	60	100	20
25	44	147	26	45.5	G 1/8	50.6	40	100	20
32	58	163	40	51.5	G 1/8	62.1	60	120	30
40	70	182	40	60.5	G 1/4	71.1	60	120	30
50	92	205	40	67.5	G 1/4	78.3	60	140	30
63	112	233	55	82.5	G 3/8	93.3	100	180	40
80	140	269	55	103.5	G 3/8	114.2	100	180	40

Piston \varnothing	MC	PL	PM	PO	PP	RT 1)	RU 2)	SG	TG
16	12	21.5	9	13.1	7.5	M5	M4	17.3	19
25	15	20	8	21.5	9.3	M5	M4	17.3	19
32	20	18.5	9.5	24.5	9.5	M6	M6	22	40
40	17	18	10	31.5	11	M6	M6	22	40
50	23	16	16	35.5	12.5	M8	M6	22	40

Rodless cylinders, Series RTC-BV

R480155522

AVENTICS
Series RTC
Rodless
cylinders

Piston Ø	MC	PL	PM	PO	PP	RT 1)	RU 2)	SG	TG
63	25	14	14	45.5	14.5	M8	M8	30	80
80	27	14	14	59.5	16.5	M8	M8	30	80

Piston Ø	W1	W2	W3	W4	W5	W6	W7	Wd1	Wd2
16	63	45.5	8	18	30	13.5	19.8	M6	M6
25	73	55.5	13	18	30	13.5	19.8	M6	M6
32	93	72.5	16	26	30	19	26.8	M8	M8
40	105	84.5	22	26	30	19	26.8	M8	M8
50	140	114.5	11	70	40	22	32.7	M12	M12
63	160	134.5	31	50	40	22	32.7	M12	M12
80	188	162.5	45	50	40	22	32.7	M12	M12

Piston Ø	WH	ZD	Moving mass kg
16	63.5	187	0.08
25	87.5	215	0.16
32	90	240	0.32
40	101.5	263	0.49
50	117.1	294.2	0.73
63	116.5	333.2	1.31
80	130.5	361	2.14

For long slide

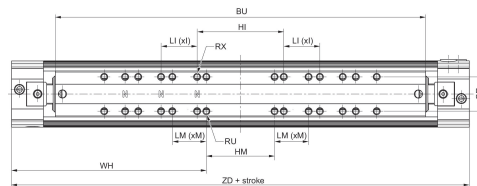

S = stroke

Piston Ø	BU	GR	HI	LI	I	HM	LM	M	RU
16	236	20	50.8	38.1	2	60	20	3	M4
25	294	20	76.2	31.75	2	40	30	3	M4
32	326	30	76.2	31.75	2	60	30	3	M6
40	364	30	76.2	31.75	3	60	30	4	M6
50	410	30	76.2	31.75	3*	60	40	3	M6
63	466	40	152.4	38.1	2	100	40	3	M8
80	538	40	152.4	38.1	3	100	40	4	M8

Piston Ø	RX	MCF	WH	ZD
16	8-36 UNF	258	122.5	305
25	8-36 UNF	313	161	362
32	1/4-20 UNC	344	171.5	403
40	1/4-20 UNC	387	192.5	445
50	1/4-20 UNC	431	219.6	499.2

Rodless cylinders, Series RTC-BV

R480155522

AVENTICS
Series RTC
Rodless
cylinders

2024-04-22

Piston Ø	RX	MCF	WH	ZD
63	5/16-18 UNC	492	233	566.2
80	5/16-18 UNC	557	265	630

Max. play and recommended max.
lever arm length



L = lever arm

M = moment (Nm)

For long slide

Piston Ø	α	β	Lx	Ly	Lz
16	0,25°	2,0° ±1°	324	188	324
25	0,25°	2,0° ±1°	434	246	434
32	0,3°	1,5° ±0,5°	480	278	480
40	0,2°	1,0° ±0,3°	550	316	550
50	0,2°	1,0° ±0,3°	634	362	634
63	0,15°	1,0° ±0,3°	736	418	736
80	0,15°	1,0° ±0,3°	870	490	870

Max. play and recommended max. lever arm length

Piston Ø	α	β	Lx	Ly	Lz
16	0,5°	2,0° ±1°	162	94	162
25	0,5°	2,0° ±1°	217	123	217
32	0,6°	1,5° ±0,5°	240	139	240
40	0,4°	1,0° ±0,3°	275	158	275
50	0,4°	1,0° ±0,3°	317	181	317
63	0,3°	1,0° ±0,3°	368	209	368
80	0,3°	1,0° ±0,3°	435	245	435