

AVENTICS Series SA1 Industrial shock absorbers

The AVENTICS Series SA1 industrial shock absorbers decelerate reliably moving masses and thereby increase process speed, production quality, the service life of production facilities and reduce operating noise.



Technical data

Industry	Industrial
Type	SA1-MA
Mounting thread	M64x2
Stroke	100 mm
Max. energy absorption/stroke	5000 Nm
Max. energy absorption/hour	350000 Nm
Cushioning	adjustable
Medium	Oil
Min. ambient temperature	-20 °C
Max. ambient temperature	80 °C
Effective mass m_e min.	1000 kg
Effective mass m_e max.	62500 kg
Min. return spring force	45 N
Max. return spring force	130 N
Min. impact speed	0.02 m/s
Max. impact speed	6 m/s
Mounting	Lock nut
Weight	3.9 kg

Industrial shock absorber, Series SA1-MA

R412010329

Series SA1

2024-01-10

Material

Material cylinder tube	Steel, chrome-plated
Surface cylinder tube	bronzed
Material piston rod	Stainless Steel
Surface piston rod	ground and hardened
Material stop	Steel, chrome-plated
Surface stop	hardened and bronzed
Material lock nut	Steel, chrome-plated
Surface lock nut	bronzed
Scraper material	Polyurethane
Part No.	R412010329

Dimensions

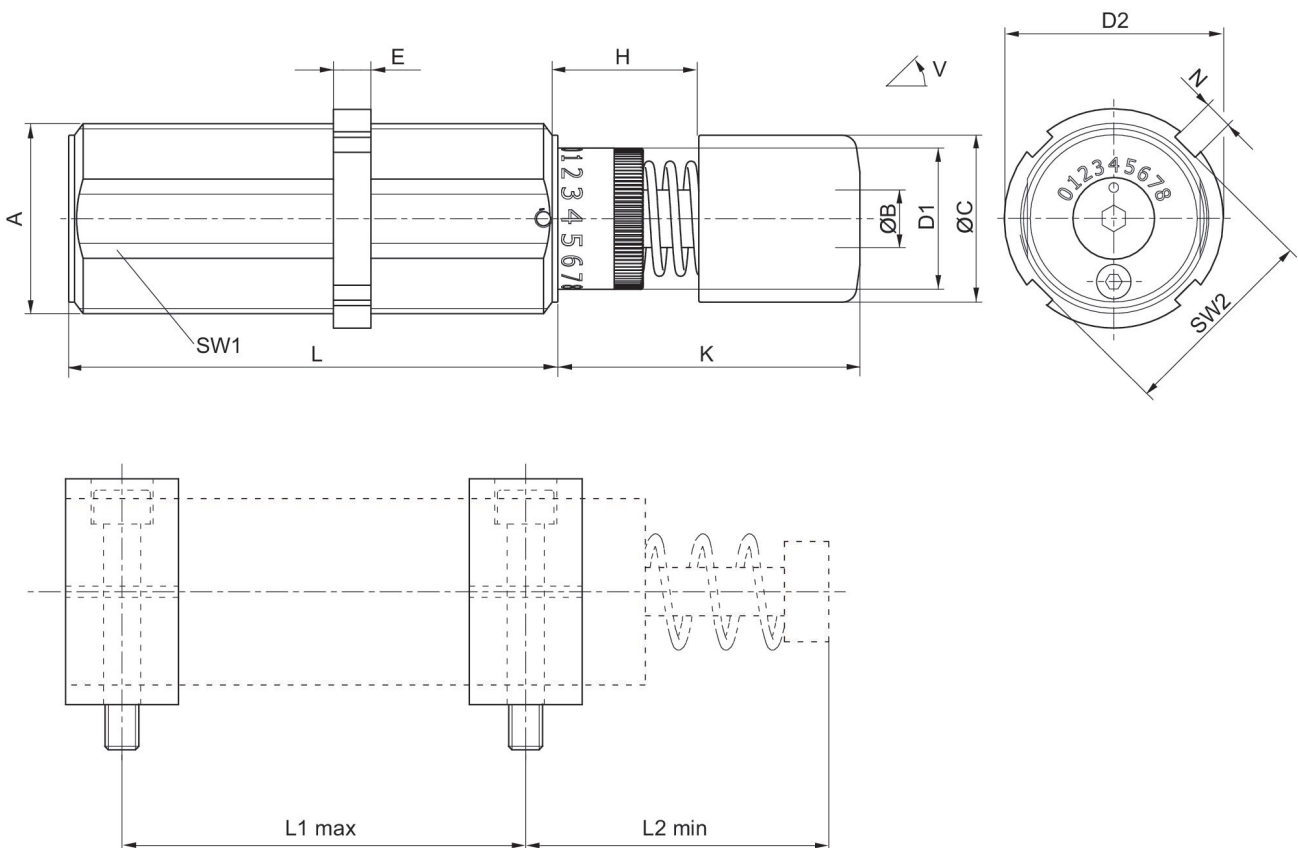

Positioning the clamping flanges
A = mounting thread
V = tilt

Industrial shock absorber, Series SA1-MA

Series SA1

R412010329

2024-01-10

Part No.	Type	Mounting thread	ØB	ØC	ØD1	ØD2	E	H	K
R412010327	SA1-MA	M33x1,5	10	29	24.5	38	6.5	25	53
R412010328	SA1-MA	M33x1,5	10	29	24.5	38	6.5	50	78
R412028893	SA1-MA	M42x3	10	29		54		50	78
R412028894	SA1-MA	M42x3	10	29		54		75	103
R412010329	SA1-MA	M64x2	22	59	51	74	10	100	157
R412010330	SA1-MA	M64x2	22	59	51	74	10	150	207

Part No.	L	N	SW1	SW2	W [°]
R412010327	85	5	30	35	4
R412010328	110	5	30	35	3
R412028893	110	6	36	51	
R412028894	140	6	51	54	
R412010329	179	10	60	71	3
R412010330	246	10	60	71	2

Part No.	Type	Mounting thread	L1 max	L2 min
R412010327	SA1-MA	M33x1,5	65	63
R412010328	SA1-MA	M33x1,5	90	88
R412010329	SA1-MA	M64x2	154	169,5
R412010330	SA1-MA	M64x2	221	219,5

You will find further dimensions on the catalog page for clamping flanges.