

AVENTICS Series SA1 Industrial shock absorbers

The AVENTICS Series SA1 industrial shock absorbers decelerate reliably moving masses and thereby increase process speed, production quality, the service life of production facilities and reduce operating noise.



Technical data

Industry	Industrial
Type	SA1-MC
Mounting thread	M10x1
Stroke	8 mm
Max. energy absorption/stroke	10 Nm
Max. energy absorption/hour	24000 Nm
Cushioning	self-compensating
Medium	Oil
Min. ambient temperature	-20 °C
Max. ambient temperature	80 °C
Effective mass m_e min.	4.3 kg
Effective mass m_e max.	20 kg
Min. return spring force	3.6 N
Max. return spring force	8 N
Mounting	Lock nut
Weight	0.02 kg

Material

Material cylinder tube	Steel, chrome-plated
------------------------	----------------------

Industrial shock absorber, Series SA1-MC

Series SA1

R412010289

2024-01-10

Surface cylinder tube	salt bath nitrocarburized
Material piston rod	Stainless Steel
Surface piston rod	ground and hardened
Material sealing for piston rod	Acrylonitrile butadiene rubber
Material stop	Polyurethane
Material lock nut	Steel, chrome-plated
Surface lock nut	steel bath nitrocarburized
Part No.	R412010289

Dimensions

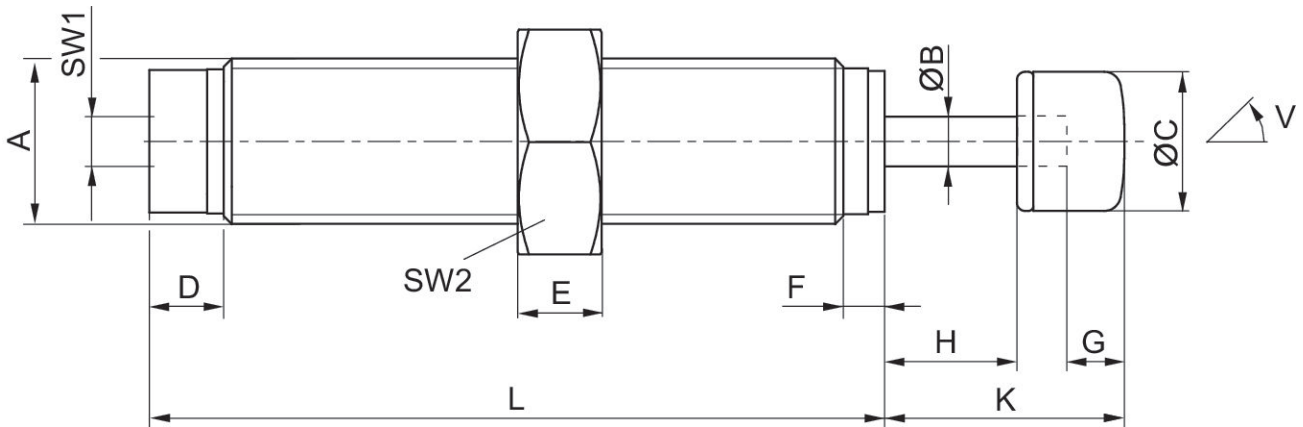

A = mounting thread
V = tilt

Part No.	Type	Mounting thread	ØB	ØC	D	E	F	G	H
R412010288	SA1-MC	M10x1	3	8.4	4.5	3	2.5	3	8
R412010289	SA1-MC	M10x1	3	8.4	4.5	3	2.5	3	8
R412010290	SA1-MC	M10x1	3	8.4	4.5	3	2.5	3	8

Part No.	K	L	SW1	SW2	W [°]
R412010288	14.5	44.5	3	13	2
R412010289	14.5	44.5	3	13	2
R412010290	14.5	44.5	3	13	2