

AVENTICS Series SA1 Industrial shock absorbers

The AVENTICS Series SA1 industrial shock absorbers decelerate reliably moving masses and thereby increase process speed, production quality, the service life of production facilities and reduce operating noise.



Technical data

Industry	Industrial
Type	SA1-MC
Mounting thread	M20x1,5
Stroke	13 mm
Max. energy absorption/stroke	65 Nm
Max. energy absorption/hour	52000 Nm
Cushioning	self-compensating
Medium	Oil
Min. ambient temperature	-20 °C
Max. ambient temperature	80 °C
Effective mass m_e min.	20 kg
Effective mass m_e max.	160 kg
Min. return spring force	12 N
Max. return spring force	23 N
Mounting	Clamping flange
Weight	0.22 kg

Material

Material cylinder tube	Steel, chrome-plated
------------------------	----------------------

Industrial shock absorber, Series SA1-MC

Series SA1

R412010317

2024-01-10

Surface cylinder tube	salt bath nitrocarburized
Material piston rod	Stainless Steel
Surface piston rod	ground and hardened
Material stop	Polyoxymethylene
Material clamping flange	Steel, chrome-plated
Surface clamping flange	salt bath nitrocarburized
Scraper material	Polyurethane
Part No.	R412010317

Dimensions

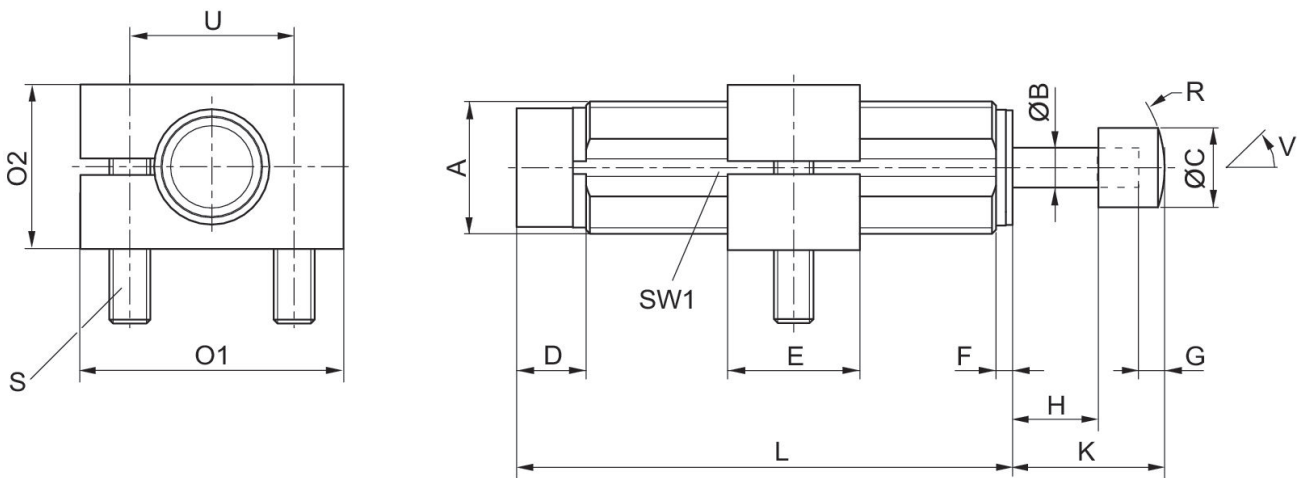

A = mounting thread
V = tilt

Part No.	Type	Mounting thread	ØB	ØC	D	E	F	G	H
R412010316	SA1-MC	M20x1,5	6	12	10.5	20	2.5	4	13
R412010317	SA1-MC	M20x1,5	6	12	10.5	20	2.5	4	13
R412010318	SA1-MC	M20x1,5	6	12	10.5	20	2.5	4	13
R412010319	SA1-MC	M20x1,5	8	16	9.5	25	3.5	5	25
R412010320	SA1-MC	M25x1,5	8	16	9.5	25	3.5	5	25
R412010321	SA1-MC	M25x1,5	8	16	9.5	25	3.5	5	25

Part No.	K	L	O1	O2	R	S	SW1	U	W [°]
R412010316	23	75	40	25	18.5	M6x30	18	28	4
R412010317	23	75	40	25	18.5	M6x30	18	28	4
R412010318	23	75	40	25	18.5	M6x30	18	28	4
R412010319	38	108	47	32	20	M6x40	23	34	2
R412010320	38	108	47	32	20	M6x40	23	34	2
R412010321	38	108	47	32	20	M6x40	23	34	2