

2/2-way stop valve, Series SC01

1823391910

General series information
AVENTICS Series SC01 Stop valves

- AVENTICS Series SC01 Stop valves are available even in 2/2 or 3/2 construction. SC01 stop valves control flow direction and support a diverse range of system requirements. Our ball valves are both reliable and robust when it comes to service and are available in various configurations and options.

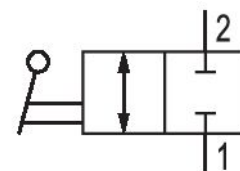

Technical data

Industry	Industrial
Type	Ball Valve
Switching principle	2/2
Medium	Compressed air
Compressed air connection 1	G 1/8
Compressed air connection type 1	Internal thread
Compressed air connection 2	G 1/8
Compressed air connection type 2	Internal thread
Min. ambient temperature	-18 °C
Max. ambient temperature	80 °C
Min. medium temperature	-18 °C
Max. medium temperature	80 °C
Working pressure min.	0 bar
Working pressure max	16 bar
Delivery unit	2 piece
Weight	0.035 kg

Material

Housing material	Brass
Housing material	nickel-plated

Seal material Polytetrafluorethylene
Material hand lever Polyamide
Part No. 1823391910

Fig. 1

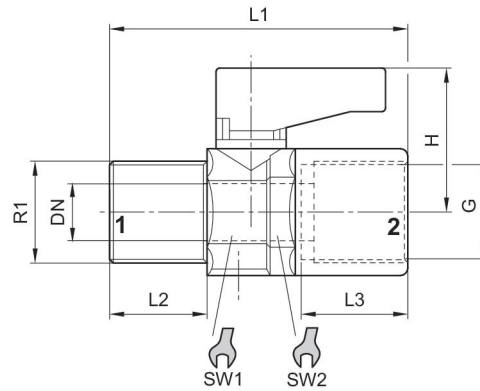

Part No.	Port G	R1	H	DN	L1	L2	L3	SW1	SW2
1823391906	G 1/8	R 1/8	21.5	5.5	36	8.6	8.6	14	15
1823391907	G 1/4	R 1/4	21.5	5.5	43	13.5	11.5	14	15
1823391908	G 3/8	R 3/8	22.5	8	46	13.5	11.8	18	19
R412010091	G 1/2	R1/2	30.5	10	57	16.5	15	22	23

Fig. 2

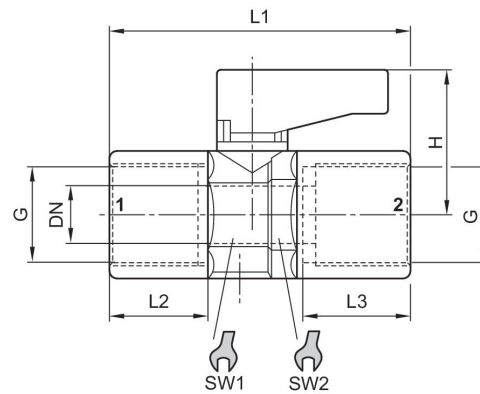

Part No.	Port G	H	DN	L1	L2	L3	SW1	SW2
1823391910	G 1/8	21.5	5.5	36	8.5	9	14	15
1823391911	G 1/4	21.5	5.5	43	12.6	11.5	14	15
1823391912	G 3/8	22.5	8	46	13	11.5	18	19