

- Installation of sensors on various cylinder series

AVENTICS Sensor mountings

AVENTICS Sensors mountings are especially designed to mount AVENTICS sensors on various cylinders.



Technical data

Industry

Industrial

For series

Archive product: Do not use in new constructions!

Min. ambient temperature

5 °C

Max. ambient temperature

60 °C

Min. cylinder Ø

2.5 mm

Max. cylinder Ø

10 mm

Scope of delivery

1 piece

Weight

0.01 kg

Material

Housing material

Aluminum

Surface housing

anodized

Part No.

3224180000

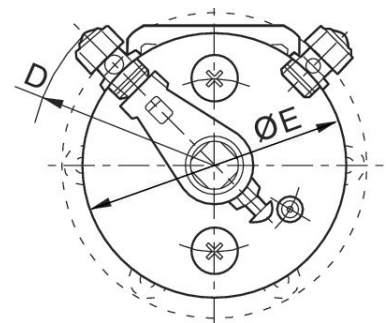
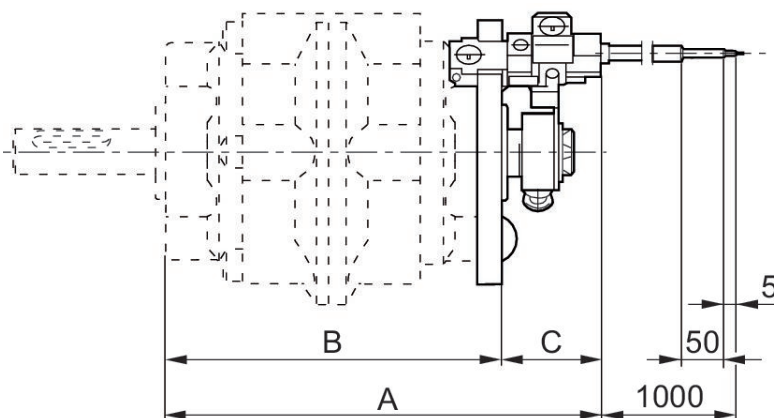

Sensor mounting

3224180000

Series CB1

2024-09-26

Part No.	Cylinders Ø	For series	A	B	C	D	E
3224160000	2.5 - 10 mm	RAK - 6S, RAK - 6D	115	87.2	25.5	R47	69
3224170000	2.5 - 10 mm	RAK - 7S, RAK - 7D	131.7	104.2	27.5	R61	97
3224180000	2.5 - 10 mm	RAK - 8S, RAK - 8D	161.2	126.2	35	R69	113