

# Sensors, Series SM6-AL

## R412010898

General series information  
AVENTICS Series SM6-AL Distance measuring sensors

- The AVENTICS Series SM6-AL are analog distance measuring sensors, which ensure a continuous detection of the piston movements in measuring ranges from 107 mm up to 1007 mm. A control element on the sensor allows for setting of the zero point and variable selection of the distance measurement range.

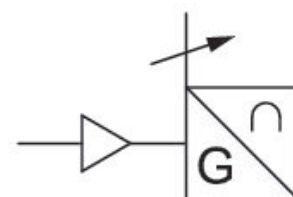

### Technical data

Industry  
Indirect mounting for series

Electrical connection

Cable

Cable length

Quiescent current (without load)

Repetitive precision max. measuring range

Maximum load (analog current output)

Output signal

Residual ripple

sampling interval

Certificates

Industrial

PRA

ITS

RTC

CVI

Plug

with cable

0.3 m

< 35 mA

typ. 0,06 % FSR

500  $\Omega$

0 - 10 V DC, 4 - 20 mA

$\leq 10$  %

1,15 ms

cULus

Protection class	IP65 IP67
Min. ambient temperature	-20 °C
Max. ambient temperature	70 °C
max. measuring range	755 mm
Max. measuring range resolution	typ. 0,03 % FSR
Linearity deviation	0,5 mm
Shock resistance	30 g / 11 ms
Vibration resistance	10 - 55 Hz, 1 mm
Display	2 LED

## Material

Housing material	Aluminum
Part No.	R412010898

## Technical information

Holders for cylinder series PRA are included in the scope of delivery. For cylinder series ITS, please order the appropriate holders separately.

FSR: Full Scale Range, max. measurement range

The IO-Link device description (IODD) for the SM6-AL distance measuring sensor is available for download in the Media Centre.

The pressure dew point must be at least 15 °C less than ambient and medium temperature and may not exceed 3 °C.

The oil content of compressed air must remain constant during the life cycle.

Use only the approved oils from AVENTICS. Further information can be found in the "Technical information" document (available in <https://www.emerson.com/en-us/support>).

## Dimensions

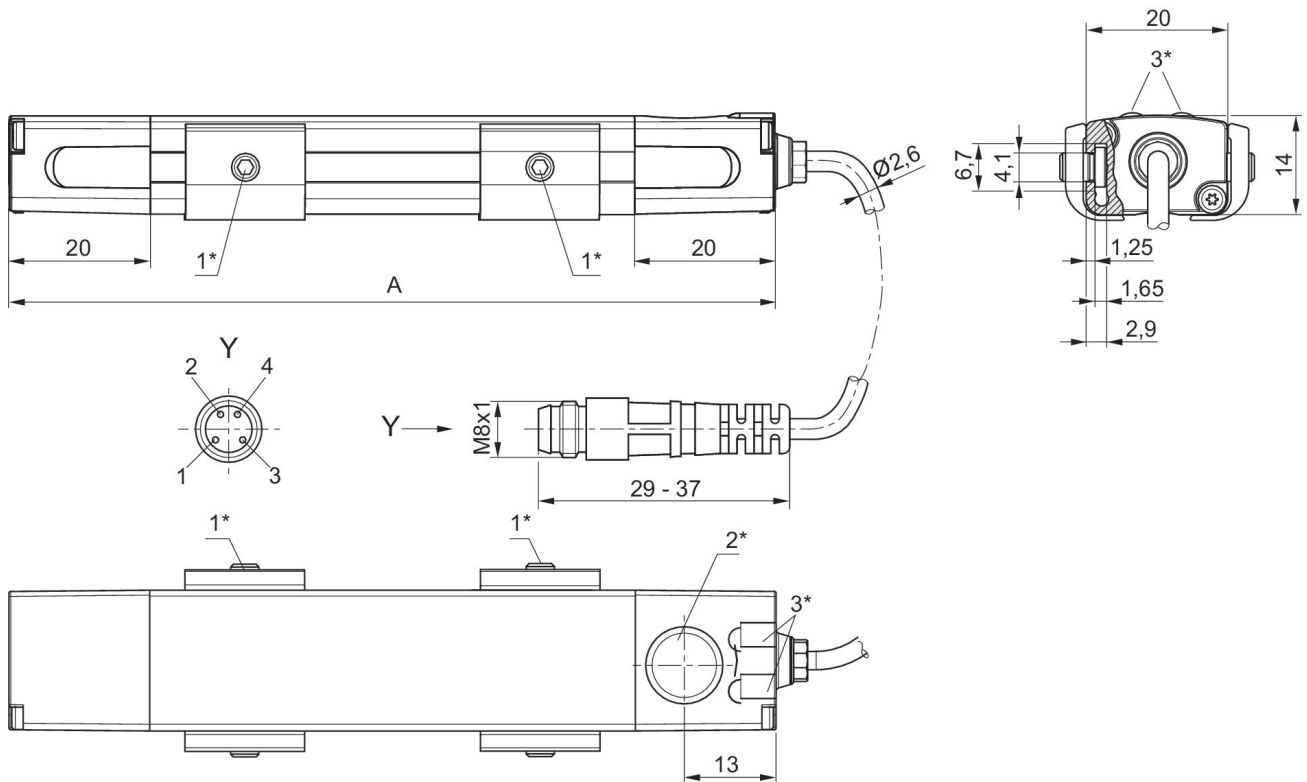

1\* = threaded pin M3x11 2\* = teach area 3\* = LED  
A = sensor length  
Pin assignment: 1 = (+), 2 = (OUT 1) 3 = (GND), 4 = (OUT 2/IO-Link), EN 60947-5-7  
LED 1: yellow = measuring operation, red = error  
LED 2: green = voltage signal, blue = current signal