

Series SPRA Electric Rod-Style Actuators

R481633876

General series information
Series SPRA Electric Rod-Style Actuators

- The AVENTICS Series SPRA electric rod-style actuators are the ideal solution to perform fast and powerful linear movements. They are very flexible, precise and energy efficient, improving sustainability and Total Cost of Ownership (TCO). The modular concept of the Series SPRA enables easy connection to your preferred motor and control system, saving you time and costs on design and programming. The Series SPRA is ISO 15552 compliant and uses high-grade materials such as a IP54S sealing system, ensuring a high level of reliability even in harsh conditions.

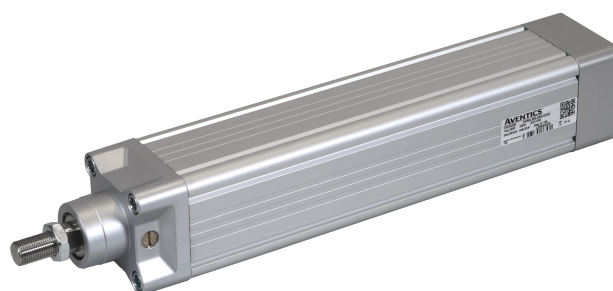

Technical data

Industry	Industrial
Piston Ø	100 mm
Piston rod thread	M27x2
Max. dynamic axial force	48 kN
Max. static axial force	60 kN
Max. dyn. axial force L10	47 kN
Dynamic load capacity	61.5 kN
Max. torque (for Fmax)	90 Nm
Max. linear speed	210 mm/s
Max. rotational speed	1260 1/min
Max. acceleration	6 m/s ²
Duty cycle	100 %

Mechanical data

Screw type	Ball screw
Screw diameter	40 mm
Screw lead	10 mm
Lead accuracy	G9

Stroke	300 mm
Internal overstroke (double)	2 mm
Backlash	0.2 mm
Efficiency [%]	>85
Inertia at 0 mm stroke	$0.00051 \cdot 10^{-4} \text{ kgm}^2$
Inertia per 100 mm stroke	$0.000144 \cdot 10^{-4} \text{ kgm}^2$
Weight 0 mm stroke	12.7 kg
Weight +100 mm stroke	2.7 kg

Environmental requirements

Protection class	IP54S
Max. humidity	95 %
Min. ambient temperature	-20 °C
Max. ambient temperature	50 °C

Material

Part No. R481633876

Dimensions in mm

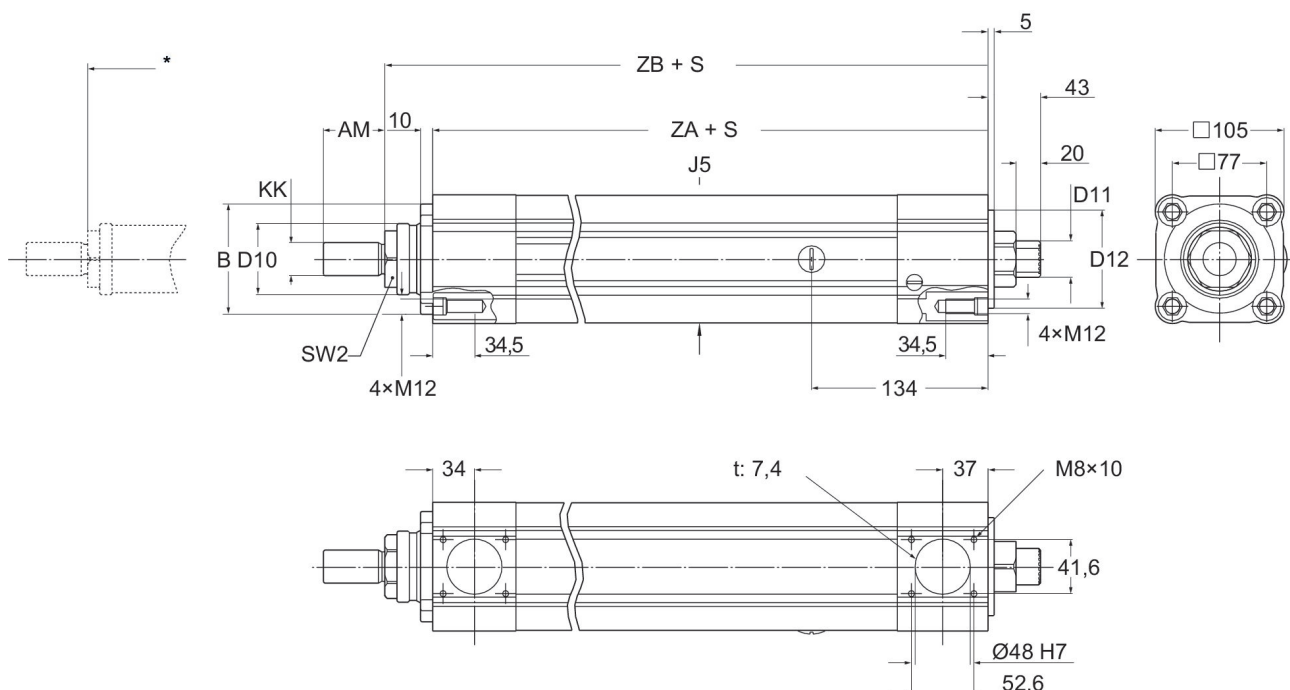

S = stroke
* Nominal stroke
t = depth

KK	SW2	J5 mm	ZA	ZB	B -0,1 / -0,35	D10	AM	D12 -0,02 / -0,07	D11
M27 x 2	AF 46	#104	287±1.5	326±2	Ø90	Ø58	50	Ø80	DIN5480 W 30x1.25x22x8f

Pressure characteristics curve

