

Series SPRA Electric Rod-Style Actuators

R481633804

General series information
Series SPRA Electric Rod-Style Actuators

- The AVENTICS Series SPRA electric rod-style actuators are the ideal solution to perform fast and powerful linear movements. They are very flexible, precise and energy efficient, improving sustainability and Total Cost of Ownership (TCO). The modular concept of the Series SPRA enables easy connection to your preferred motor and control system, saving you time and costs on design and programming. The Series SPRA is ISO 15552 compliant and uses high-grade materials such as a IP54S sealing system, ensuring a high level of reliability even in harsh conditions.

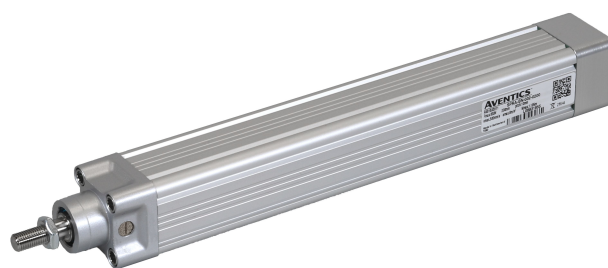

Technical data

Industry	Industrial
Piston Ø	32 mm
Piston rod thread	M10x1,25
Max. dynamic axial force	0.7 kN
Max. static axial force	0.7 kN
Dynamic load capacity	2.8 kN
Max. torque (for Fmax)	0.45 Nm
Max. linear speed	150 mm/s
Max. rotational speed	3000 1/min
Max. acceleration	6 m/s ²
Duty cycle	100 %

Mechanical data

Screw type	Ball screw
Screw diameter	10 mm
Screw lead	3 mm
Lead accuracy	G7
Stroke	150 mm

Internal overstroke (double)	1 mm
Backlash	0.06 mm
Efficiency [%]	75
Inertia at 0 mm stroke	$0.042 \cdot 10^{-4} \text{ kgm}^2$
Inertia per 100 mm stroke	$0.0047 \cdot 10^{-4} \text{ kgm}^2$
Weight 0 mm stroke	0.74 kg
Weight +100 mm stroke	0.34 kg

Environmental requirements

Standardization	ISO 15552
Protection class	IP54S
Max. humidity	95 %
Min. ambient temperature	0 °C
Max. ambient temperature	50 °C

Material

Part No. R481633804

Dimensions in mm

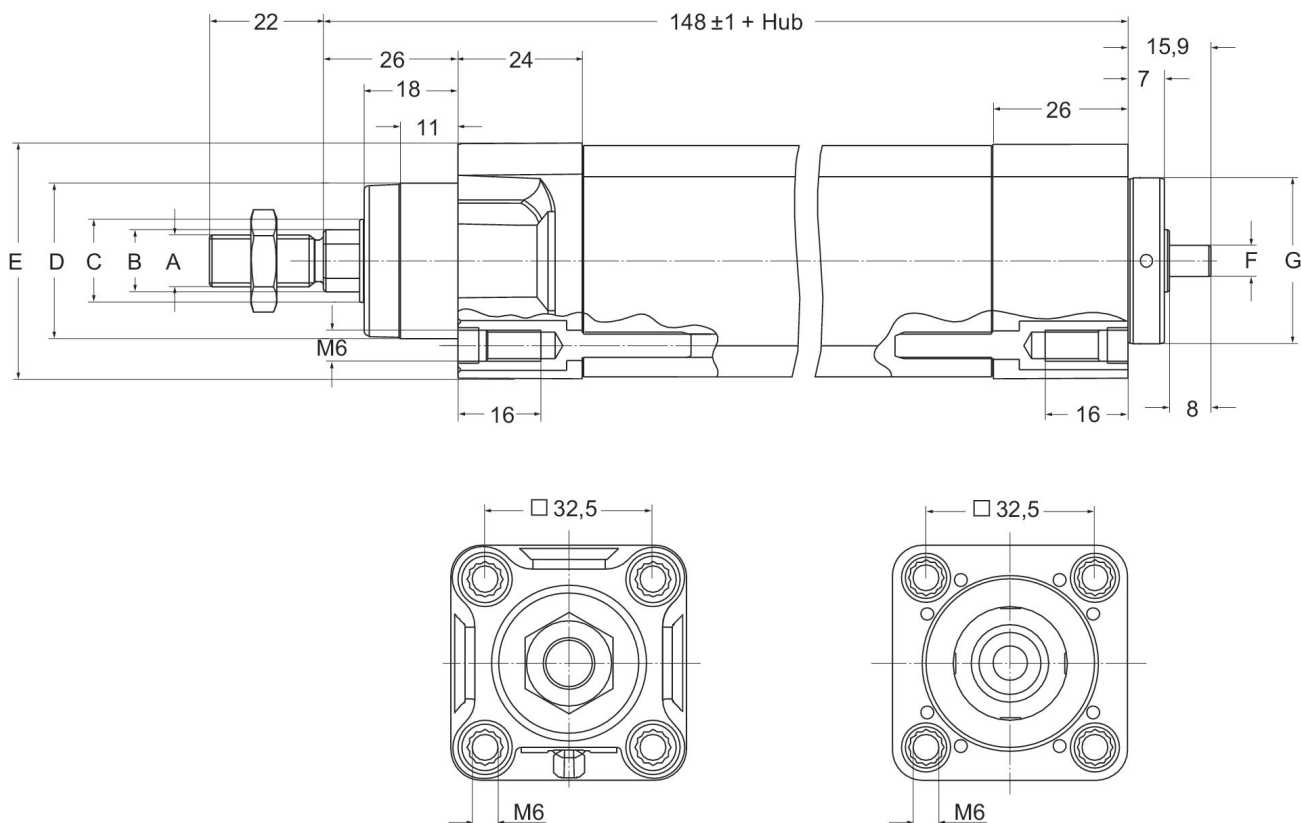

	A	B mm	C	D	E	F	G -0,05 / -0,07
SPRA-32	M10 x 1,25	Ø12	Ø16	Ø30 d11	#45.7	Ø6 h6	Ø32

Pressure characteristics curve

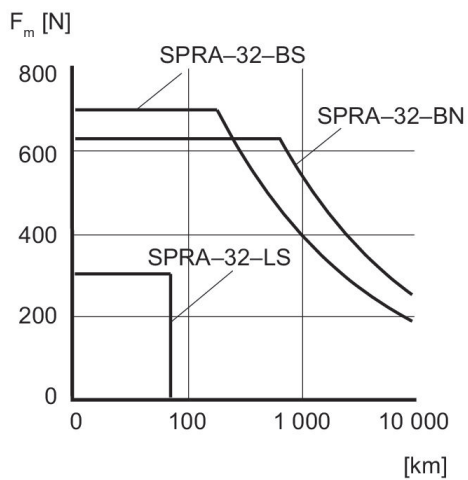

Diagram

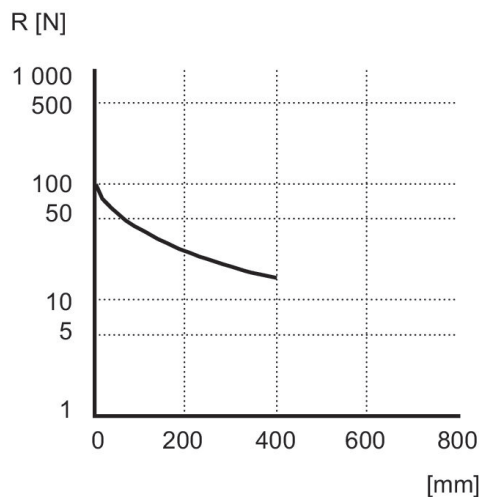

Diagram

