

# Series SPRA Electric Rod-Style Actuators

## R481633815

General series information  
Series SPRA Electric Rod-Style Actuators

- The AVENTICS Series SPRA electric rod-style actuators are the ideal solution to perform fast and powerful linear movements. They are very flexible, precise and energy efficient, improving sustainability and Total Cost of Ownership (TCO). The modular concept of the Series SPRA enables easy connection to your preferred motor and control system, saving you time and costs on design and programming. The Series SPRA is ISO 15552 compliant and uses high-grade materials such as a IP54S sealing system, ensuring a high level of reliability even in harsh conditions.

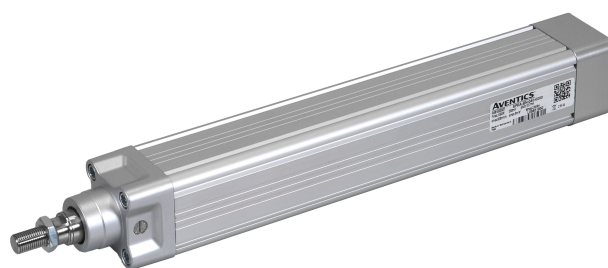

### Technical data

Industry	Industrial
Piston Ø	40 mm
Piston rod thread	M12x1,25
Max. dynamic axial force	0.6 kN
Max. static axial force	1.5 kN
Max. torque (for Fmax)	0.63 Nm
Max. linear speed	70 mm/s
Max. rotational speed	1680 1/min
Max. acceleration	1 m/s <sup>2</sup>
Duty cycle	60 %

### Mechanical data

Screw type	Lead screw
Screw diameter	12.5 mm
Screw lead	2.5 mm
Stroke	200 mm
Internal overstroke (double)	1 mm
Efficiency [%]	38

Inertia at 0 mm stroke	0.1262 *10 <sup>-4</sup> kgm <sup>2</sup>
Inertia per 100 mm stroke	0.0123 *10 <sup>-4</sup> kgm <sup>2</sup>
Weight 0 mm stroke	1.25 kg
Weight +100 mm stroke	0.46 kg

### Environmental requirements

Standardization	ISO 15552
Protection class	IP54S
Max. humidity	95 %
Min. ambient temperature	0 °C
Max. ambient temperature	50 °C

### Material

Part No.	R481633815
----------	------------

### Dimensions in mm

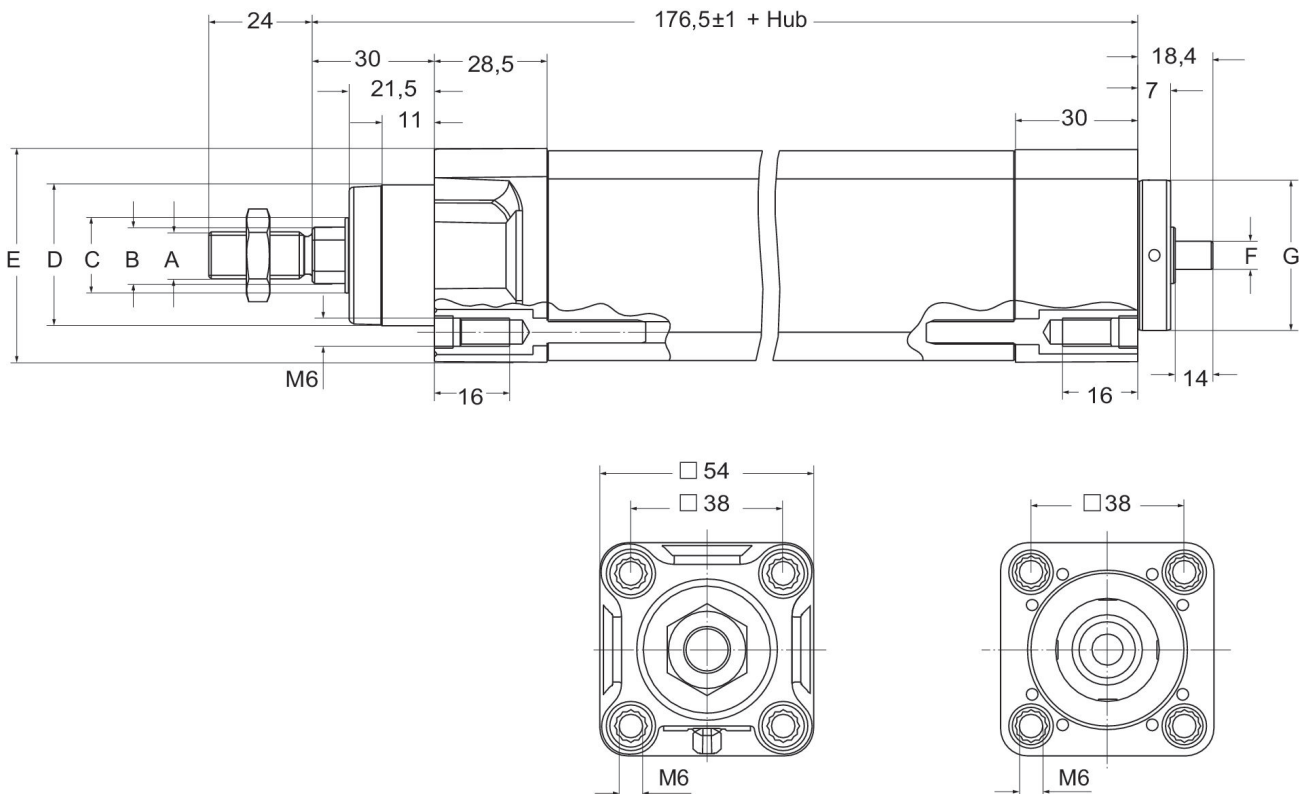

	A	B mm	C	D	E	F	G -0,09 / -0,1
SPRA-40	M12 x 1,25	Ø16	Ø20	Ø35 d11	54,3	Ø8 h6	Ø40

### Pressure characteristics curve

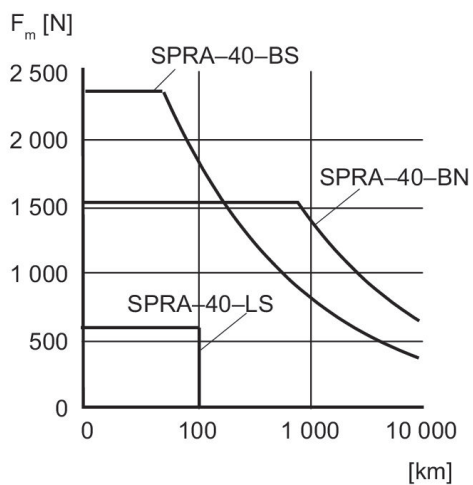

### Diagram

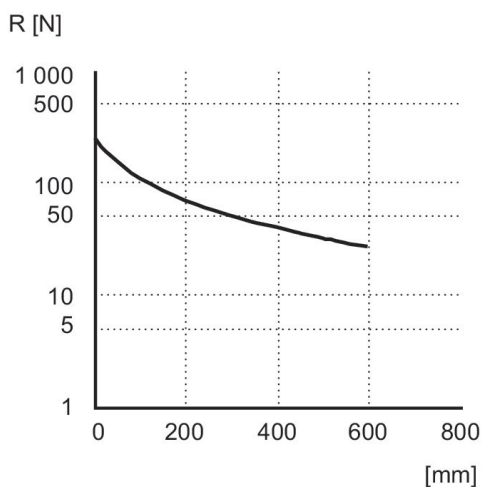

### Diagram

