

Short-stroke cylinder, Series SSI, single-acting, with magnetic piston

Series SSI

2024-08-09

R480637926

- Ideal for simple assembly and clamping movements, tight installation space, and short strokes
- Mount on moving machine parts possible thanks to their low weight
- Intelligent connection concept
- Available in piston diameters from 12 mm to 100 mm
- Available as piston rod, single or double-acting cylinders, with a hollow piston rod, as a non-rotating version with a front plate, or an especially short version without a magnet



AVENTICS Series SSI Short-stroke cylinders (ISO 15524)

The AVENTICS Series SSI are short stroke cylinders in accordance with the latest ISO standard 15524. The cylinders are compact and up to 30% lighter than comparable cylinders thanks to weight optimized profiles. In addition, they provide a high degree of flexibility in sensor assembly and extremely effective elastic cushioning.



Technical data

Industry	Industrial
Standards	ISO 15524
Piston Ø	20 mm
Stroke	25 mm
Ports	M5
Functional principle	Single-acting, retracted without pressure
Cushioning	Elastic cushioning
Magnetic piston	Piston with magnet
Environmental requirements	Industry standard
Piston rod thread - type	Piston rod: internal thread
Piston rod thread	M5
Piston rod	single
Scraper	Standard Industry Scraper
Pressure for determining piston forces	6,3 bar
Retracting piston force	6.5 N
Extracting piston force	198 N
Min. ambient temperature	-20 °C
Max. ambient temperature	80 °C
Min. working pressure	1.5 bar

Short-stroke cylinder, Series SSI, single-acting, with magnetic piston

Series SSI

2024-08-09

R480637926

Max. working pressure 10 bar

Impact energy 0.04 J

Weight 0 mm stroke 0.077 kg

Weight +10 mm stroke 0.02 kg

Stroke max. 25 mm

Medium Compressed air

Min. medium temperature -20 °C

Max. medium temperature 80 °C

Max. particle size 50 µm

Min. oil content of compressed air 0 mg/m³

Max. oil content of compressed air 5 mg/m³

Material

Piston rod Stainless Steel

Seal material Nitrile butadiene rubber

Material, front cover Aluminum

Cylinder tube Aluminum

End cover Aluminum

Part No. R480637926

Technical information

Please note that this variant does not use a scraper.

For this variant with external thread, two different external threads with the dimensions indicated below can be selected in the configurator .

The pressure dew point must be at least 15 °C less than ambient and medium temperature and may not exceed 3 °C.

The oil content of compressed air must remain constant during the life cycle.

Use only the approved oils from AVENTICS. Further information can be found in the "Technical information" document (available in <https://www.emerson.com/en-us/support>).

Short-stroke cylinder, Series SSI, single-acting, with magnetic piston

Series SSI

2024-08-09

R480637926
Dimensions

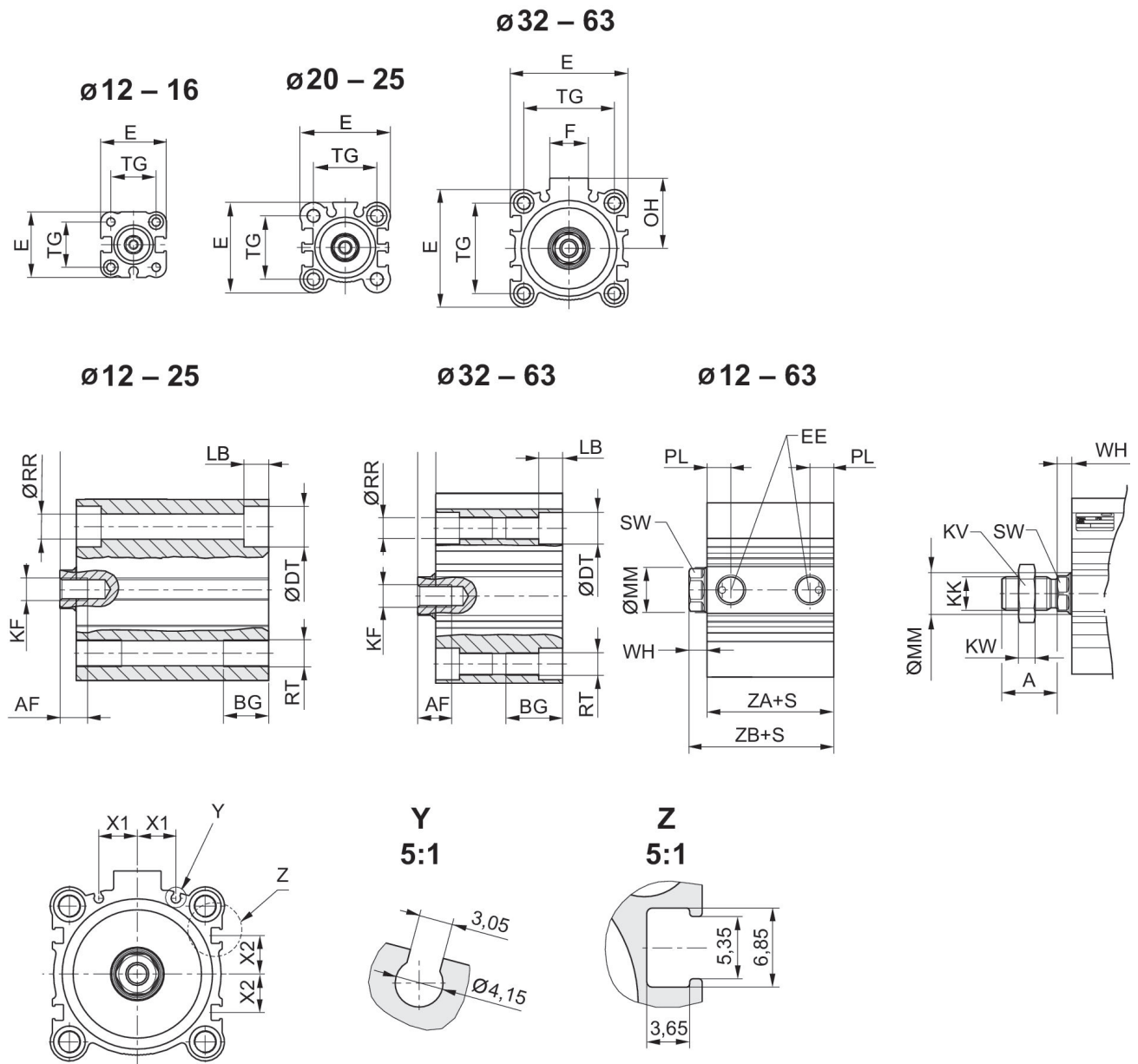

S = stroke

Piston Ø	A ±0.3	AF	BG	ØDT	E	EE	F	KF	KK 1)
12	10,5	6	7	6,5	25	M5	-	M3	M4
16	12	8	7	6,5	29	M5	-	M4	M6
20	14	7	10	9	36	M5	-	M5	M8
25	17,5	12	10	9	40	M5	-	M6	M10x1,25
32	21,5	13	16	9	45	G 1/8	17	M8	M12x1,25
40	21,5	13	16	9	52	G 1/8	17	M8	M12x1,25
50	26,5	15	20	11	64	G 1/4	21	M10	M16x1,5
63	26,5	15	25	14	77	G 1/4	21	M10	M16x1,5

Short-stroke cylinder, Series SSI, single-acting, with magnetic piston

Series SSI

2024-08-09

R480637926

Piston Ø	KK 2)	KV 1)	KV 2)	KW 1)	KW 2)	LB max.	ØMM f8	OH	PL
12	M5	7	8	2,2	2,7	3,5	6	-	5,5
16	M6	10	10	3,2	3,2	3,5	8	-	5,5
20	M8	13	13	4	4	5,5	10	-	5,5
25	M10x1,25	17	17	6	6	5,5	12	-	5,5
32	M14x1,5	18	22	6	8	5,5	16	27	7,5
40	M14x1,5	18	22	6	8	5,5	16	31	7,5
50	M18x1,5	24	27	8	9	8	20	39	10,5
63	M18x1,5	24	27	8	9	10,5	20	45,5	10,5

Piston Ø	ØRR	RT	SW	TG	WH 3)	WH 4)	X1	X2	ZA±0,2
12	3,7	M4	5	15,5 ±0,3	3,5 ±1,5	3,5 ±1,5	0	0	28
16	3,7	M4	7	20 ±0,3	3,5 ±1,5	3,5 ±1,5	0	0	30,5
20	5,55	M6	8	25,5 ±0,3	4,5 ±1,5	4,5 ±1,5	5,7	4,275	31,5 5)
25	5,55	M6	10	28 ±0,3	5 ±1,5	5 ±1,5	6	5	32,5 5)
32	5,55	M6	13	34 ±0,3	7 ±2	7 ±2	8,5	7,5	33
40	5,55	M6	13	40 ±0,3	7 ±2	7 ±2	10,75	11	39,5
50	7.4	M8	17	50 ±0,5	8 ±2	7 ±2	14	13	40,5
63	9,3	M10	17	60 ±0,5	8 ±2	7 ±2	17	17	46

Piston Ø	ZB±2 3)	ZB±2 4)
12	31,5	31,5
16	34	34
20	36 5)	36 5)
25	37,5 5)	37,5 5)
32	40	40
40	46,5	46,5
50	48,5	47,5
63	54	53

- 1) Compatible with piston rod accessories
 2) Compatible with third-party products
 3) Internal thread

- 4) External thread
 5) For stroke 11-25 mm + 6.5 mm

Short-stroke cylinder, Series SSI, single-acting, with magnetic piston

Series SSI

2024-08-09

R480637926

Retracting piston force

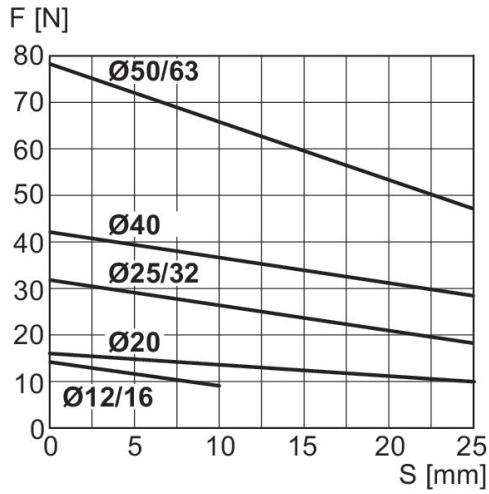

F = spring return force, s = return stroke

Maximum admissible lateral force

$\text{Ø} 12 \dots 25 \text{ mm}$

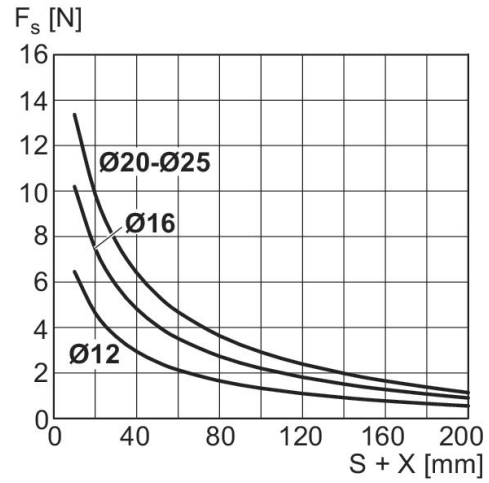

X = distance between force application point and cylinder cover
 F_s = lateral force
 S = stroke

Maximum admissible lateral force

$\text{Ø} 32 \dots 63 \text{ mm}$

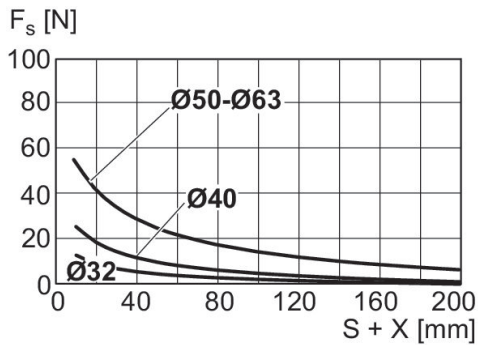

X = distance between force application point and cylinder cover
 F_s = lateral force
 S = stroke

Maximum admissible lateral force

$\text{Ø} 12 \dots 25 \text{ mm}$

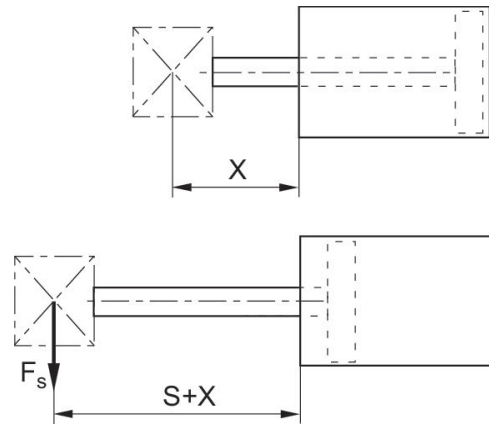

X = distance between force application point and cylinder cover
 F_s = lateral force
 S = stroke

Short-stroke cylinder, Series SSI, single-acting, with magnetic piston

Series SSI

2024-08-09

R480637926
Overview drawing



Use our Internet configurator to order variants with an external thread.

NOTE: This overview drawing is only for orientation to indicate where the various accessory parts can be fastened to the cylinder. The illustration has been simplified for this purpose. It is thus not possible to derive the dimensions from this overview.