

AVENTICS Series ST4 Magnetic proximity sensors

The AVENTICS Series ST4 sensors can be integrated with all AVENTICS pneumatic actuators and are ideal for small handling. The Series ST4 can be assembled quickly and easily with just a quarter turn of the combination screw.

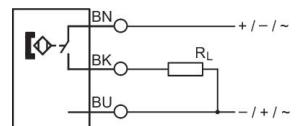

Technical data

Industry

Direct mounting for series

Indirect mounting for series

Slot width

Cable

Type of contact

Switching capacity

Certificates

Protection class

Industrial

PRA

SSI

GSU

RTC

CKP

GPC

MSC

MSN

RCM

CVI

MNI

CSL-RD

ICM

4 mm C-slot

with cable

Reed

3 W / 3 VA

UL (Underwriters Laboratories)

cULus

RoHS

IP65

Sensor, Series ST4

R412019686

Sensors,
Series ST4

2023-10-25

	IP67
Min. ambient temperature	-30 °C
Max. ambient temperature	80 °C
Voltage drop U at I _{max}	≤ 0,5 V
Max. DC switching current	0.13 A
Max. AC switching current	0.13 A
Switching point precision	±0,1 mT
Switching logic	NO (make contact)
Display	LED
LED status display	Yellow
Electrical connection 2, type	Plug
Electrical connection 2, thread size	M8
Electrical connection 2, number of poles	3-pin
Min. operating voltage DC	5 V DC
Max. operating voltage DC	30 V DC
Short circuit resistance	Protected against polarity reversal
Shock resistance	30 g / 11 ms
Vibration resistance	10 - 55 Hz, 1 mm
Cable length L	0.5 m
Mounting screw	Combination: slotted and hexagon socket

Material

Housing material	Polyamide fiber-glass reinforced
Material cable sheath	Polyurethane
Part No.	R412019686

Technical information

The max. switching capacity must not be exceeded.

The pressure dew point must be at least 15 °C less than ambient and medium temperature and may not exceed 3 °C.

The oil content of compressed air must remain constant during the life cycle.

Use only the approved oils from AVENTICS. Further information can be found in the "Technical information" document (available in <https://www.emerson.com/en-us/support>).

Sensor, Series ST4

R412019686

Sensors,
Series ST4

2023-10-25

Dimensions

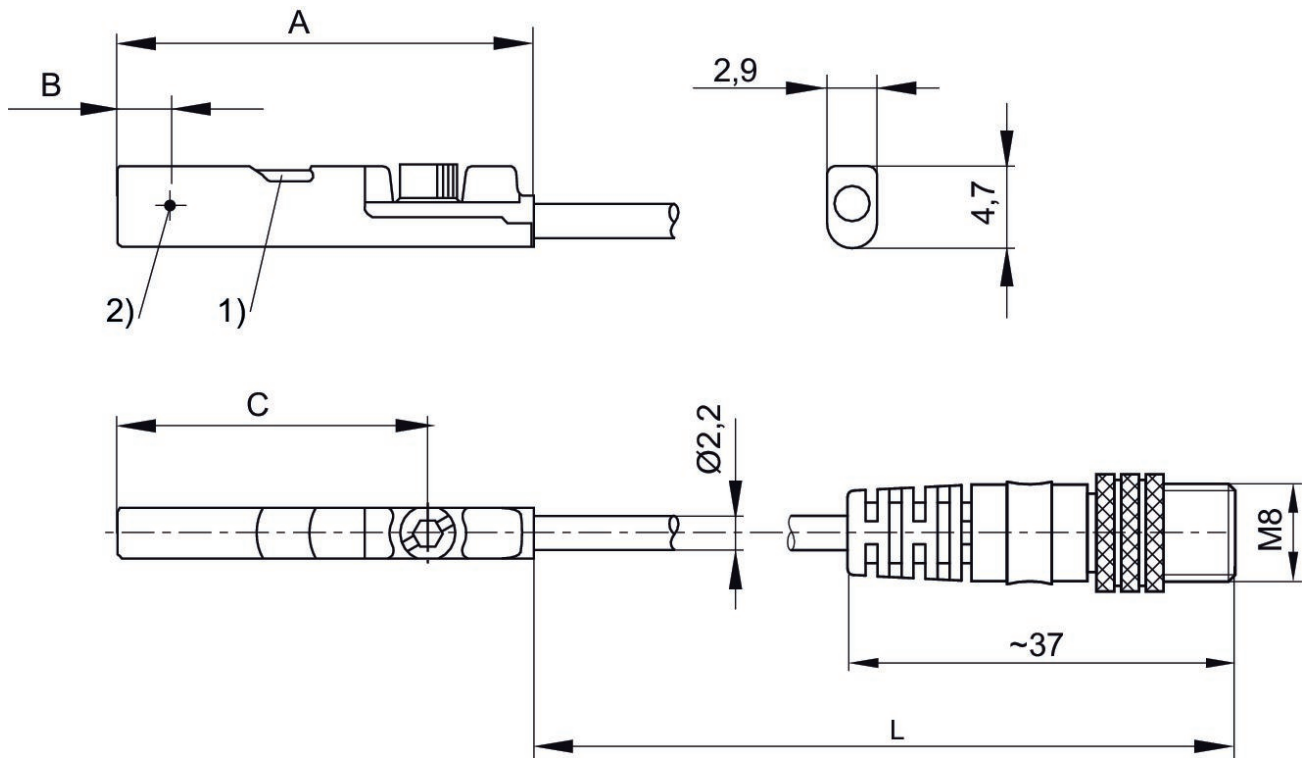

1) LED 2) Switching point
L = cable length

Part No.	A	B	C
R412019490	26.3	6.3	20.3
R412019686	26.3	6.3	20.3
R412019493	23.7	2.8	17.7
R412019687	23.7	2.8	17.7

Sensor, Series ST4

R412019686

Sensors,
Series ST4

2023-10-25

Pin assignment M8x1 (3-pin)

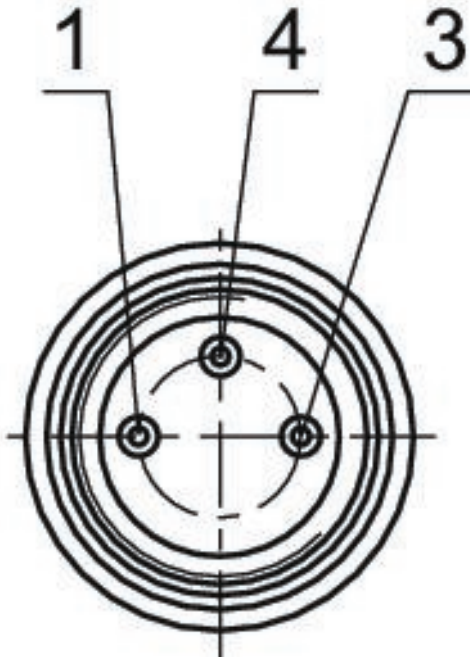

Pin assignments

Pin	Allocation
1	(+)
3	(-)
4	(OUT)