

AVENTICS Series TC15 Directional valves

The AVENTICS Series TC08/TC15 includes a wide range of spool valves with housings made of high-performance polymers with robust and flexible metal inserts. It is designed for flow rate performances from 800 to 1500 l/min. These directional valves are easy to assemble, making them ideal for applications requiring the highest efficiency in limited spaces.

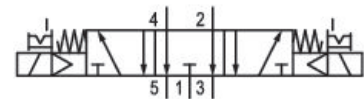

Technical data

Industry	Industrial
Activation	Electrically
Note	Operating voltage 12 V AC, 110 V AC, 230 V AC
Valve type	Spool valve, positive overlapping
Valve function	Exhausted Center
Actuating control	Double Solenoid
Sealing principle	Soft seal
Connection type	Pipe connection
Manual override	with detent
Standard compressed air connection	according to ANSI B1.20.3
Compressed air connection input	1/4 - 18 NPTF
Compressed air connection output	1/4 - 18 NPTF
Compressed air connection, exhaust	1/4 - 18 NPTF
Nominal flow Qn	1300 l/min
Flow conductance b	0.31
Flow conductance C	5.9 l/(s*bar)

5/3-directional valve, Series TC15 - inch

2024-05-06

R422101283

Min. working pressure	3 bar
Max. working pressure	10 bar
Min. control pressure	3 bar
Max. control pressure	10 bar
Electrical connection type	Plug
Electrical connection size	ISO 15217, form C
Connector standard	ISO 15217
Protection class with connection	IP65
Operational voltage	230 V AC
Operational voltage AC at 50 Hz	230 V
Voltage tolerance AC 50 Hz	-10% / +10%
Operational voltage AC at 60 Hz	230 V
Voltage tolerance AC 60 Hz	-10% / +10%
Pilot	Internal
Coil width	15.6 mm
Pilot valve width	15 mm
Nominal resistance	185 Ω
Holding power AC 50 Hz	3 VA
Holding power AC 60 Hz	2.4 VA
Switch-on power AC 50 Hz	4 VA
Switch-on power AC 60 Hz	3.8 VA
Duty cycle	100 %
Typ. switch-on time	12 ms
Typ. switch-off time	13 ms
Min. ambient temperature	-10 °C
Max. ambient temperature	50 °C
Min. medium temperature	-10 °C
Max. medium temperature	50 °C
Medium	Compressed air
Min. oil content of compressed air	0 mg/m ³
Max. oil content of compressed air	5 mg/m ³
Max. particle size	5 μ m
Mounting on manifold strip	P-strip
Mounting screw tightening torque	2.5 Nm

5/3-directional valve, Series TC15 - inch

2024-05-06

R422101283

Weight 0.309 kg

Material

Housing material	Polyamide fiber-glass reinforced
Seal material	Acrylonitrile butadiene rubber Hydrogenated nitrile butadiene rubber
Material threaded bushing	Brass Die cast zinc
Material front plate	Polyamide fiber-glass reinforced

Part No. R422101283

Technical information

The min. control pressure must be adhered to, since otherwise faulty switching and valve failure may result!

The pressure dew point must be at least 15 °C less than ambient and medium temperature and may not exceed 3 °C.

The oil content of compressed air must remain constant during the life cycle.

Use only the approved oils from AVENTICS. Further information can be found in the "Technical information" document (available in <https://www.emerson.com/en-us/support>).

5/3-directional valve, Series TC15 - inch

2024-05-06

R422101283

Dimensions in inches

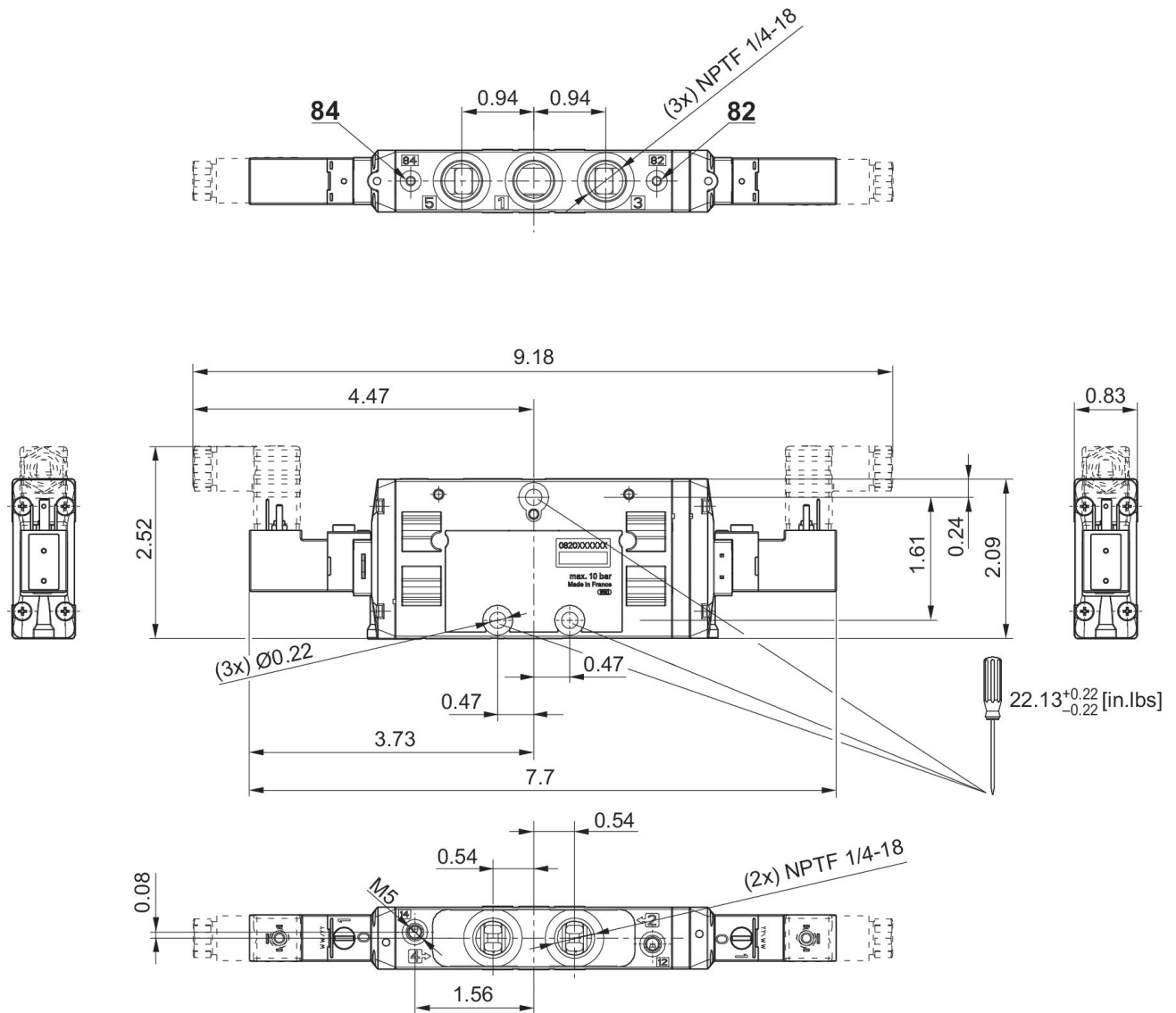

5/3-directional valve, Series TC15 - inch

2024-05-06

R422101283

Dimensions in mm

