

Flange mounting, Series MF1, MF2

R432013382

Flange
mountings

2023-11-14

AVENTICS Flange mountings



Technical data

Industry	Industrial
Standardization	NFPA
Piston diameter	63.5 mm
Weight	0.0544 kg

Material

Housing material	Aluminum
Part No.	R432013382

Dimensions in inches

Flange mounting, Series MF1, MF2

R432013382

Flange
mountings

2023-11-14

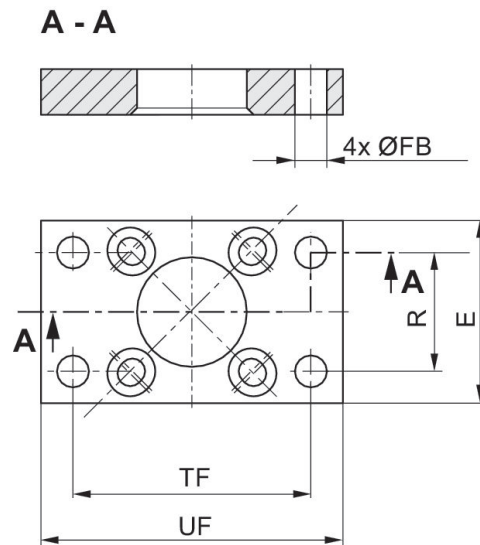

Dimensions in inches

Part No.	Ø	E	Ø FB	R	TF	UF
R432013373	38.1	2.00	0.34	1.43	2.75	3.38
R432012520	50.8	2.50	0.41	1.84	3.38	4.13
R432013382	63.5	3.00	0.41	2.19	3.88	4.63
R432013388	82.55	3.50	0.47	2.76	4.69	5.50
R432013396	101.6	4.50	0.47	3.32	5.44	6.25