

## AVENTICS Series TRB Tie rod cylinders (ISO 1552)

The AVENTICS Series TRB (ISO 1552) cylinders are among the most frequently implemented in industries where heavy duty cylinders are required, such as wood and aluminium, steel and automotive, heavy-duty machinery and mining to name just a few.



### Technical data

Industry	Industrial
Standards	ISO 1552
Piston Ø	32 mm
Stroke	80 mm
Ports	G 1/8
Functional principle	Double-acting
Cushioning	Pneumatic adjustable cushioning
Magnetic piston	Piston with magnet
Environmental requirements	Industry standard
Piston rod thread - type	External thread
Piston rod thread	M10x1,25
Piston rod	single
Cylinder special features	Bellows
Scraper	Standard Industry Scraper
Pressure for determining piston forces	6,3 bar
Retracting piston force	435 N
Extracting piston force	505 N
Min. ambient temperature	-20 °C
Max. ambient temperature	80 °C

# Tie rod cylinder ISO 15552, Series TRB

series TRB

R481602133

2024-04-26

---

Min. working pressure	1.5 bar
Max. working pressure	10 bar
Max. speed	1 m/s
Cushioning length	16.5 mm
Cushioning energy	4.8 J
Stroke max.	250 mm
Medium	Compressed air
Min. medium temperature	-20 °C
Max. medium temperature	80 °C
Max. particle size	50 µm
Min. oil content of compressed air	0 mg/m <sup>3</sup>
Max. oil content of compressed air	5 mg/m <sup>3</sup>

## Material

Piston rod	Stainless Steel
Scraper material	Polyurethane
Material tie-rod	Stainless Steel
Seal material	Polyurethane
Material, front cover	Die-cast aluminum
Cylinder tube	Aluminum
End cover	Die-cast aluminum
Nut for piston rod	Steel, chrome-plated
Bellow	Carboxylated nitrile rubber
Part No.	R481602133

## Technical information

The pressure dew point must be at least 15 °C less than ambient and medium temperature and may not exceed 3 °C.

The oil content of compressed air must remain constant during the life cycle.

Use only the approved oils from AVENTICS. Further information can be found in the "Technical information" document (available in <https://www.emerson.com/en-us/support>).

# Tie rod cylinder ISO 1552, Series TRB

series TRB

R481602133

2024-04-26

## Dimensions

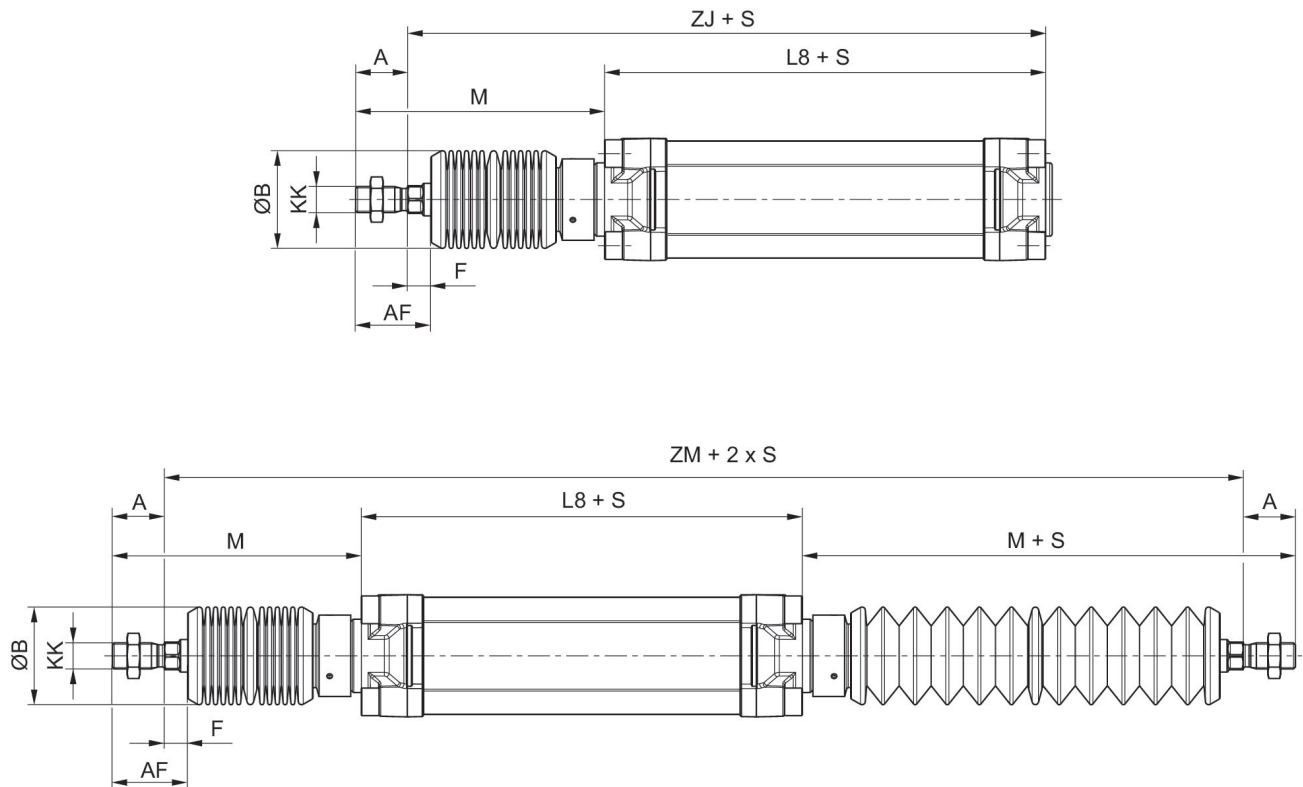

S = stroke

## Stroke-dependent dimensions

Piston Ø	S=0-75 M	S=0-75 ZJ	S=0-75 ZM	S=76-150 M	S=76-150 ZJ	S=76-150 ZM	S=151-250 M	S=151-250 ZJ	S=151-250 ZM
32	81	153	212	107	179	264	127	199	304
40	138	219	333	138	219	333	138	219	333
50	153	227	348	153	227	348	153	227	348
63	153	242	363	153	242	363	153	242	363
80	170	258	388	170	258	388	170	258	388
100	160	258	378	160	258	378	160	258	378
125	188	294	418	188	294	428	188	294	428

Piston Ø	S=251-5000 M	S=251-500 ZJ	S=251-500 ZM	S=501-750 M	S=501-750 ZJ	S=501-750 ZM	S=751-1000 M	S=751-1000 ZJ	S=751-1000 ZM
32	-	-	-	-	-	-	-	-	-
40	218	299	493	-	-	-	-	-	-
50	233	307	508	313	387	668	-	-	-
63	233	322	523	313	402	683	394	483	845
80	250	338	548	330	418	708	411	499	870
100	220	318	498	280	378	618	340	438	738
125	248	354	548	308	414	668	368	474	788

S = stroke

# Tie rod cylinder ISO 1552, Series TRB

R481602133

series TRB

2024-04-26

	A	Ø B	KK	L8	AF	F
R481602131	22	42	M10x1.25	94	34	12
R481602139	24	42	M12x1.25	105	39	15
R481602150	32	64	M16x1,5	106	47	15
R481602161	32	64	M16x1,5	121	47	15
R481602172	40	64	M20x1,5	128	57	17
R481602183	40	64	M20x1,5	138	57	17
R481602194	54	94	M27x2	160	71	17

## Cushioning diagram



$v_1$  = Piston velocity [m/s]  $m$  = Cushionable mass [kg]

# Tie rod cylinder ISO 1552, Series TRB

series TRB

R481602133

2024-04-26

