

AVENTICS Series TRB Tie rod cylinders (ISO 15552)

The AVENTICS Series TRB (ISO 15552) cylinders are among the most frequently implemented in industries where heavy duty cylinders are required, such as wood and aluminium, steel and automotive, heavy-duty machinery and mining to name just a few.

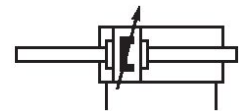

Technical data

Industry	Industrial
Standards	ISO 15552
Piston Ø	32 mm
Stroke	80 mm
Ports	G 1/8
Functional principle	Double-acting
Cushioning	Pneumatic adjustable cushioning
Magnetic piston	Piston with magnet
Environmental requirements	Industry standard ATEX optional
Piston rod thread - type	External thread
Piston rod thread	M10x1,25
Piston rod	through
Scraper	Standard Industry Scraper
Pressure for determining piston forces	6,3 bar
Retracting piston force	435 N
Extracting piston force	435 N
Min. ambient temperature	-20 °C
Max. ambient temperature	80 °C
Min. working pressure	1.5 bar

Tie rod cylinder ISO 15552, Series TRB

series TRB

0822340503

2024-04-26

Max. working pressure	10 bar
Cushioning length	16.5 mm
Cushioning energy	4.8 J
Weight 0 mm stroke	0.52 kg
Weight +10 mm stroke	0.033 kg
Stroke max.	1500 mm
Medium	Compressed air
Min. medium temperature	-20 °C
Max. medium temperature	80 °C
Max. particle size	50 µm
Min. oil content of compressed air	0 mg/m ³
Max. oil content of compressed air	5 mg/m ³

Material

Piston rod	Stainless Steel
Scraper material	Polyurethane
Material tie-rod	Stainless Steel
Seal material	Polyurethane
Material, front cover	Die-cast aluminum
Cylinder tube	Aluminum
End cover	Die-cast aluminum
Nut for piston rod	Steel, chrome-plated
Part No.	0822340503

Technical information

The pressure dew point must be at least 15 °C less than ambient and medium temperature and may not exceed 3 °C.

The oil content of compressed air must remain constant during the life cycle.

Use only the approved oils from AVENTICS. Further information can be found in the “Technical information” document (available in <https://www.emerson.com/en-us/support>).

Tie rod cylinder ISO 1552, Series TRB

series TRB

0822340503

2024-04-26

Dimensions

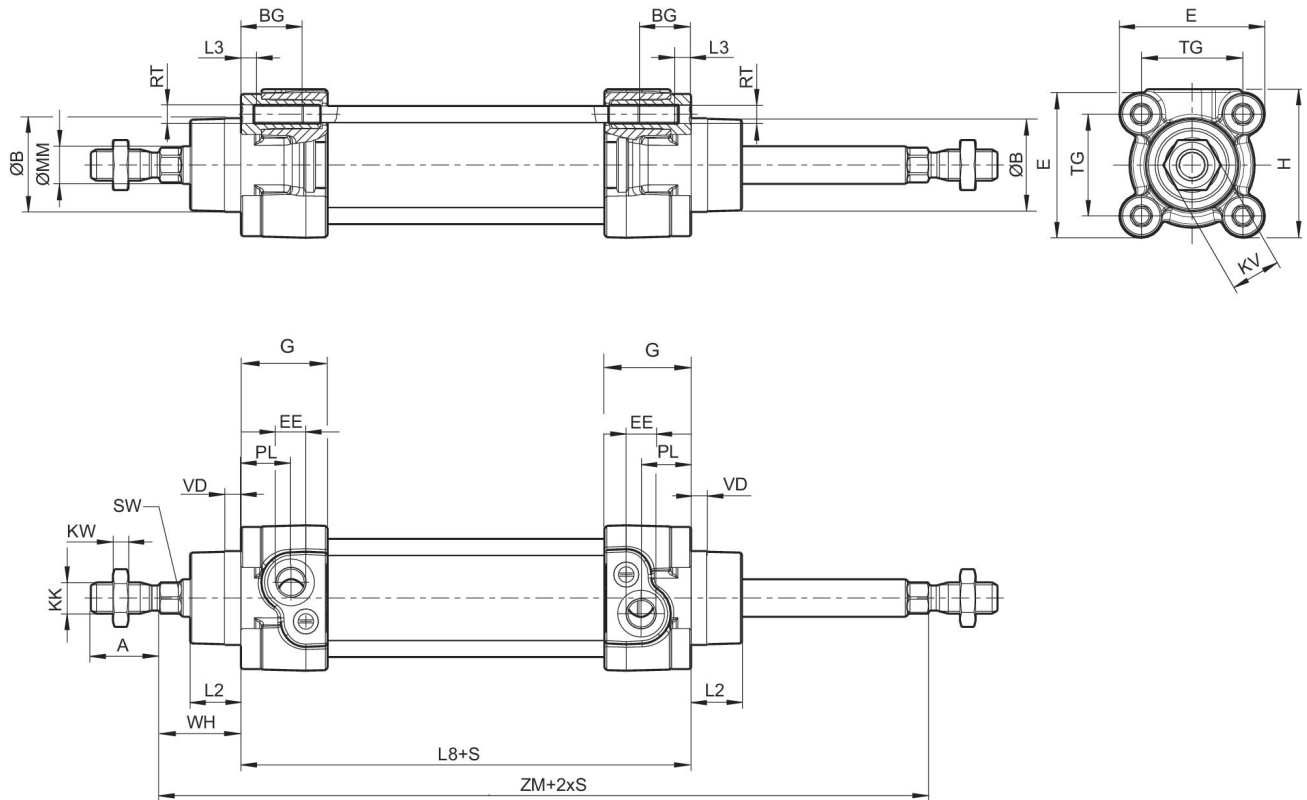

S = stroke

Piston \varnothing	A -2	$\varnothing B$ d11	BG min.	E	EE	G	H	KK	KV
32	22	30	16	46.5	G1/8	27.75	47.5	M10x1,25	16
40	24	35	16	53	G1/4	33.25	53	M12x1,25	18
50	32	40	16	65	G1/4	31	65	M16x1,5	24
63	32	45	16	75	G3/8	38.25	75	M16x1,5	24
80	40	45	17	95	G3/8	38.25	95	M20x1,5	30
100	40	55	17	115	G1/2	42.25	115	M20x1,5	30
125	54	60	20	140	G1/2	53.85	140	M27x2	41

Piston \varnothing	KW	$\varnothing MM$ f8	PL	L2	L3 $\pm 0,5$	L8	RT	SW	TG
32	5	12	16	16.25	4.5	94 $\pm 0,4$	M6	10	32,5 $\pm 0,5$
40	6	16	20	18.25	4.5	105 $\pm 0,7$	M6	13	38 $\pm 0,5$
50	8	20	19	25	4.5	106 $\pm 0,7$	M8	17	46,5 $\pm 0,6$
63	8	20	24	25	4.5	121 $\pm 0,8$	M8	17	56,5 $\pm 0,7$
80	10	25	23.5	33	0	128 $\pm 0,8$	M10	22	72 $\pm 0,7$
100	10	25	25	36	0	138 ± 1	M10	22	89 $\pm 0,7$
125	13.5	32	33	45	0	160 ± 1	M12	27	110 $\pm 1,1$

Piston \varnothing	VD	WH	ZM
32	5	26 $\pm 1,4$	146+3/-1,5

Tie rod cylinder ISO 1552, Series TRB

series TRB

0822340503

2024-04-26

Piston Ø	VD	WH	ZM
40	5	30±1,4	165+3/-1,5
50	5	37±1,4	180+3/-1,5
63	5	37±1,8	195+3/-1,5
80	5	46±1,8	220+3/-1,5
100	5	51±1,8	240+3,5/-2
125	7	65±2,2	290+3,5/-2

Cushioning diagram



v_i = Piston velocity [m/s] m = Cushionable mass [kg]

Tie rod cylinder ISO 1552, Series TRB

series TRB

0822340503

2024-04-26

