

AVENTICS Series TRB Tie rod cylinders (ISO 1552)

The AVENTICS Series TRB (ISO 1552) cylinders are among the most frequently implemented in industries where heavy duty cylinders are required, such as wood and aluminium, steel and automotive, heavy-duty machinery and mining to name just a few.

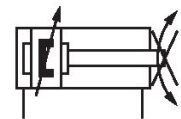

Technical data

Industry	Industrial
Standards	ISO 15552
Piston Ø	32 mm
Stroke	125 mm
Ports	G 1/8
Functional principle	Double-acting
Cushioning	Pneumatic adjustable cushioning
Magnetic piston	Piston with magnet
Environmental requirements	Industry standard
Piston rod thread - type	External thread
Piston rod thread	M10x1,25
Piston rod	non-rotating
Scraper	Standard Industry Scraper
Pressure for determining piston forces	6,3 bar
Retracting piston force	435 N
Extracting piston force	505 N
Min. ambient temperature	-20 °C
Max. ambient temperature	80 °C
Min. working pressure	1.5 bar

Tie rod cylinder ISO 15552, Series TRB

series TRB

R481602017

2024-04-26

Max. working pressure	10 bar
Cushioning length	16.5 mm
Cushioning energy	4.8 J
Max. torque for torsion protection	0.75 Nm
Rotation angle tolerance (±)	1.8 °
Weight 0 mm stroke	0.46 kg
Weight +10 mm stroke	0.024 kg
Stroke max.	1500 mm
Medium	Compressed air
Min. medium temperature	-20 °C
Max. medium temperature	80 °C
Max. particle size	50 µm
Min. oil content of compressed air	0 mg/m ³
Max. oil content of compressed air	5 mg/m ³

Material

Piston rod	Stainless Steel
Scraper material	Polyurethane
Material tie-rod	Stainless Steel
Seal material	Polyurethane
Material, front cover	Die-cast aluminum
Cylinder tube	Aluminum
End cover	Die-cast aluminum
Nut for piston rod	Steel, chrome-plated
Part No.	R481602017

Technical information

The pressure dew point must be at least 15 °C less than ambient and medium temperature and may not exceed 3 °C.

The oil content of compressed air must remain constant during the life cycle.

Use only the approved oils from AVENTICS. Further information can be found in the “Technical information” document (available in <https://www.emerson.com/en-us/support>).

Tie rod cylinder ISO 15552, Series TRB

series TRB

R481602017

2024-04-26

Dimensions

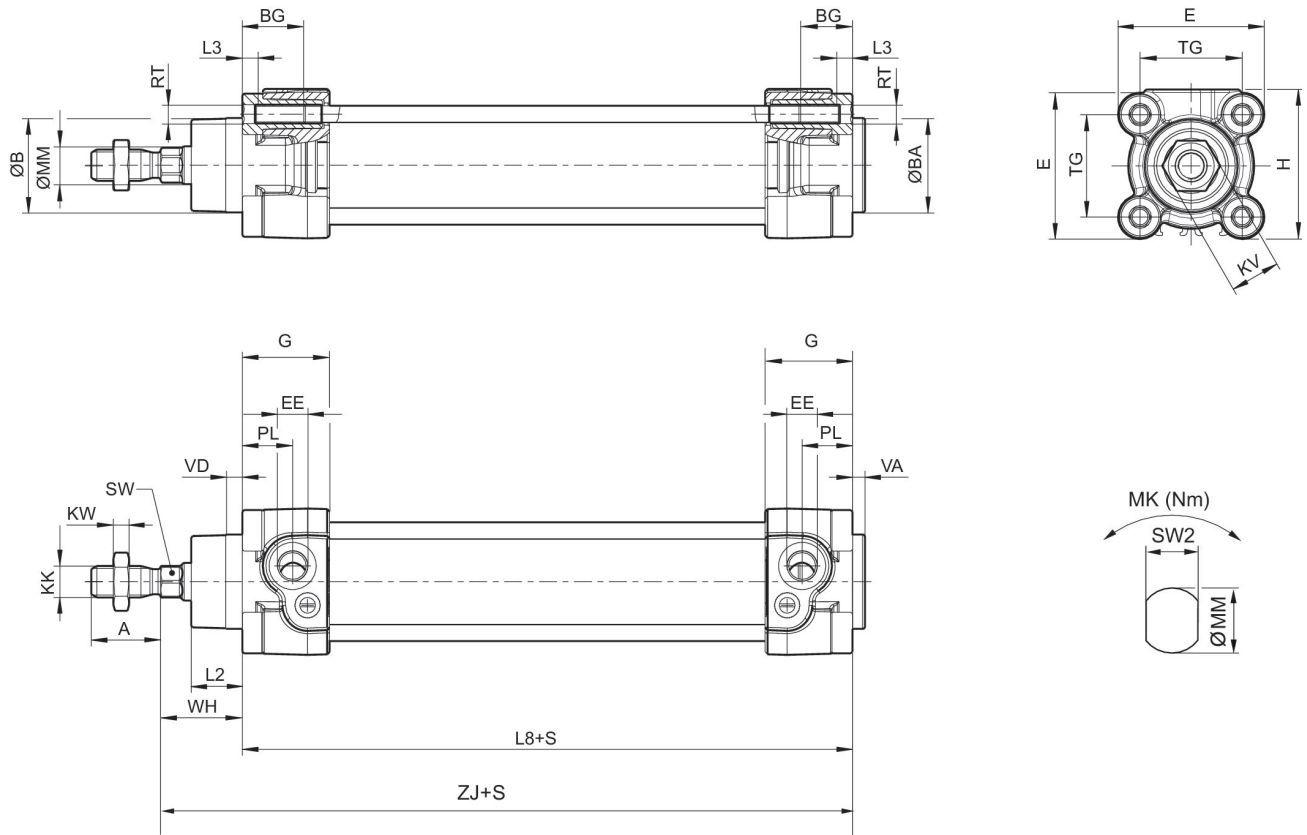

S = stroke

Piston \varnothing	A -2	$\varnothing B$ d11	$\varnothing BA$ d11	BG min.	E	EE	G	H	KF
32	22	30	30	16	46.5	G 1/8	27.75	47.5	M6
40	24	35	35	16	53	G 1/4	33.25	53	M8
50	32	40	40	16	65	G 1/4	31	65	M10
63	32	45	45	16	75	G 3/8	38.25	75	M10

Piston \varnothing	KK	KV	KW	$\varnothing MM$ f8	PL	L2	L3 $\pm 0,5$	L8	RT
32	M10x1,25	16	5	12	16	16.25	4.5	94 $\pm 0,4$	M6
40	M12x1,25	18	6	16	20	18.25	4.5	105 $\pm 0,7$	M6
50	M16x1,5	24	8	20	19	25	4.5	106 $\pm 0,7$	M8
63	M16x1,5	24	8	20	24	25	4.5	121 $\pm 0,8$	M8

Piston \varnothing	SW	TG	VA -1	VD	WH	ZJ	MK	SW2
32	10	32,5 $\pm 0,5$	4	5	26 $\pm 1,4$	120	0.75	10
40	13	38 $\pm 0,5$	4	5	30 $\pm 1,4$	135	1.5	13
50	16*	46,5 $\pm 0,6$	4	5	37 $\pm 1,4$	143	2	16
63	16*	56,5 $\pm 0,7$	4	5	37 $\pm 1,8$	158	2	16

* not according to ISO 15552

Cushioning diagram



v_1 = Piston velocity [m/s] m = Cushionable mass [kg]

Tie rod cylinder ISO 1552, Series TRB

series TRB

R481602017

2024-04-26

