

AVENTICS Series TRB Tie rod cylinders (ISO 15552)

The AVENTICS Series TRB (ISO 15552) cylinders are among the most frequently implemented in industries where heavy duty cylinders are required, such as wood and aluminium, steel and automotive, heavy-duty machinery and mining to name just a few.

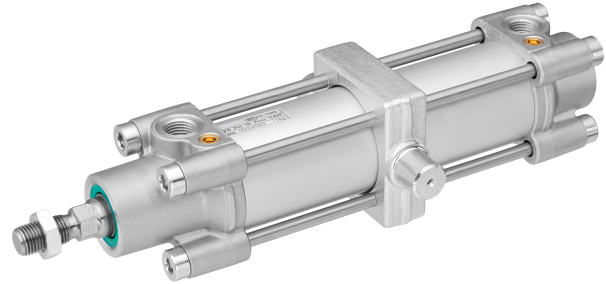

Technical data

Industry	Industrial
Standards	ISO 15552
Piston Ø	50 mm
Stroke	125 mm
Ports	G 1/4
Functional principle	Double-acting
Cushioning	Pneumatic adjustable cushioning
Magnetic piston	Piston with magnet
Environmental requirements	Industry standard ATEX optional
Piston rod thread - type	External thread
Piston rod thread	M16x1,5
Piston rod	single
Cylinder special features	with trunnion mounting
Scraper	Standard Industry Scraper
Pressure for determining piston forces	6,3 bar
Retracting piston force	1035 N
Extracting piston force	1235 N
Min. ambient temperature	-20 °C
Max. ambient temperature	80 °C

Tie rod cylinder ISO 15552, Series TRB

series TRB

0822342904

2024-04-26

Min. working pressure	1.5 bar
Max. working pressure	10 bar
Cushioning length	17 mm
Cushioning energy	15 J
Weight 0 mm stroke	1.84 kg
Weight +10 mm stroke	0.036 kg
Stroke max.	2100 mm
Medium	Compressed air
Min. medium temperature	-20 °C
Max. medium temperature	80 °C
Max. particle size	50 µm
Min. oil content of compressed air	0 mg/m ³
Max. oil content of compressed air	5 mg/m ³

Material

Piston rod	Stainless Steel
Scraper material	Polyurethane
Material tie-rod	Steel, chrome-plated
Seal material	Polyurethane
Material, front cover	Die-cast aluminum
Cylinder tube	Aluminum
End cover	Die-cast aluminum
Nut for piston rod	Steel, chrome-plated
Trunnion mounting	Nodular graphite iron
Part No.	0822342904

Technical information

NOTE: The orientation and position of the trunnion mounting in the center of the cylinder may not be changed!

The pressure dew point must be at least 15 °C less than ambient and medium temperature and may not exceed 3 °C.

The oil content of compressed air must remain constant during the life cycle.

Use only the approved oils from AVENTICS. Further information can be found in the "Technical information" document (available in <https://www.emerson.com/en-us/support>).

Tie rod cylinder ISO 1552, Series TRB

series TRB

0822342904

2024-04-26

Dimensions

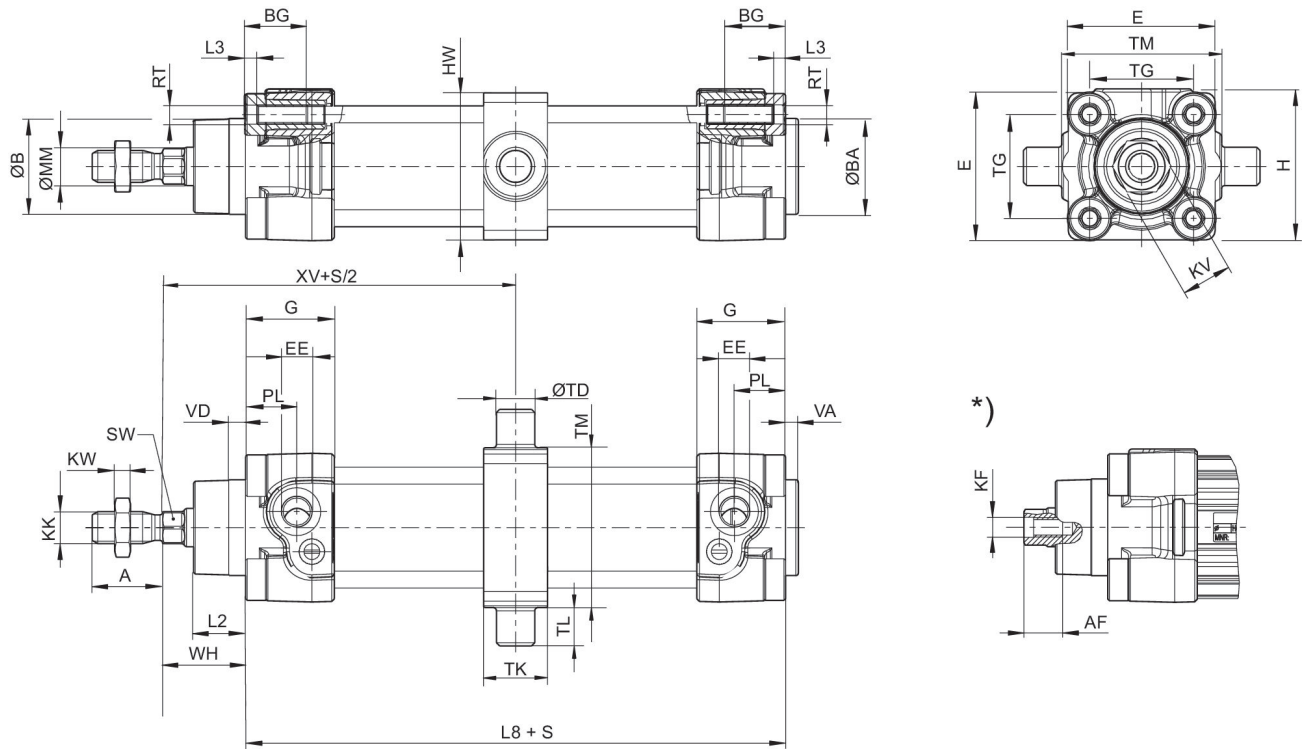

S = stroke

*) For cylinders with optional piston rod with internal thread

Piston Ø	A -2	AF+1	ØB d11	ØBA d11	BG min.	E	EE	G	H
32	22	12	30	30	16	46.5	G1/8	27.75	47.5
40	24	13.5	35	35	16	53	G1/4	33.25	53
50	32	17	40	40	16	65	G1/4	31	65
63	32	17	45	45	16	75	G3/8	38.25	75
80	40	21	45	45	17	95	G3/8	38.25	95
100	40	21	55	55	17	115	G1/2	42.25	115
125	54	28	60	60	20	140	G1/2	53.85	140

Piston Ø	KF	KK	KV	KW	ØMM f8	PL	L2	L3 ±0,5	L8
32	M6	M10x1,25	16	5	12	16	16.25	4.5	94±0,4
40	M8	M12x1,25	18	6	16	20	18.25	4.5	105±0,7
50	M10	M16x1,5	24	8	20	19	25	4.5	106±0,7
63	M10	M16x1,5	24	8	20	24	25	4.5	121±0,8
80	M12	M20x1,5	30	10	25	23.5	33	0	128±0,8
100	M12	M20x1,5	30	10	25	25	36	0	138±1
125	M16	M27x2	41	13.5	32	33	45	0	160±1

Piston Ø	RT	SW	TG	VA -1	VD	WH	HW	ØTD e9	TK
32	M6	10	32,5±0,5	4	5	26±1,4	46	12	20
40	M6	13	38±0,5	4	5	30±1,4	59	16	20

Tie rod cylinder ISO 15552, Series TRB

series TRB

0822342904

2024-04-26

Piston Ø	RT	SW	TG	VA -1	VD	WH	HW	ØTD e9	TK
50	M8	17	46,5±0,6	4	5	37±1,4	69	16	25
63	M8	17	56,5±0,7	4	5	37±1,8	84	20	30
80	M10	22	72±0,7	4	5	46±1,8	102	20	35
100	M10	22	89±0,7	4	5	51±1,8	125	25	46
125	M12	27	110±1,1	6	7	65±2,2	155	25	32

Piston Ø	TL h14	TM h14	XV
32	12	50	73
40	16	63	82.5
50	16	75	90
63	20	90	97.5
80	20	110	110
100	25	132	120
125	25	160	145

Cushioning diagram

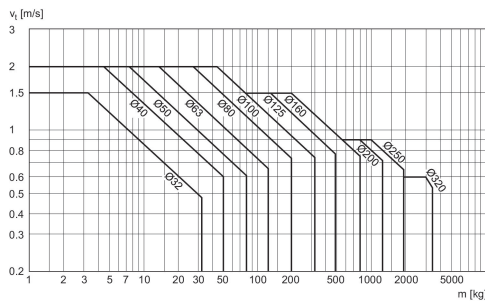

v_1 = Piston velocity [m/s] m = Cushionable mass [kg]

Tie rod cylinder ISO 1552, Series TRB

series TRB

0822342904

2024-04-26

