

AVENTICS Series TRB Tie rod cylinders (ISO 1552)

The AVENTICS Series TRB (ISO 1552) cylinders are among the most frequently implemented in industries where heavy duty cylinders are required, such as wood and aluminium, steel and automotive, heavy-duty machinery and mining to name just a few.

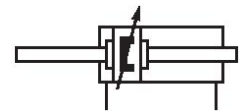

Technical data

Industry	Industrial
Piston Ø	80 mm
Stroke	254 mm
Ports	3/8 NPT
Functional principle	Double-acting
Cushioning	Pneumatic adjustable cushioning
Magnetic piston	Piston with magnet
Environmental requirements	Industry standard ATEX optional
Piston rod thread - type	External thread
Piston rod thread	3/4-16 UNF
Scraper	Standard Industry Scraper
Pressure for determining piston forces	6,3 bar
Retracting piston force	2855 N
Extracting piston force	2855 N
Min. ambient temperature	-20 °C
Max. ambient temperature	80 °C
Min. working pressure	2 bar
Max. working pressure	10 bar
Cushioning length	19.5 mm

Tie rod cylinder ISO 15552, Series TRB - inch

R480177190

TRB

2024-04-26

Cushioning energy	54 J
Weight 0 mm stroke	2.67 kg
Weight +10 mm stroke	0.099 kg
Stroke max.	2800 mm
Medium	Compressed air
Min. medium temperature	-20 °C
Max. medium temperature	80 °C
Max. particle size	50 µm
Min. oil content of compressed air	0 mg/m ³
Max. oil content of compressed air	5 mg/m ³

Material

Piston rod	Stainless Steel
Scraper material	Polyurethane
Material tie-rod	Steel, chrome-plated
Seal material	Polyurethane
Material, front cover	Die-cast aluminum
Cylinder tube	Aluminum
End cover	Die-cast aluminum
Nut for piston rod	Steel, chrome-plated
Part No.	R480177190

Technical information

The pressure dew point must be at least 15 °C less than ambient and medium temperature and may not exceed 3 °C.

The oil content of compressed air must remain constant during the life cycle.

Use only the approved oils from AVENTICS. Further information can be found in the “Technical information” document (available in <https://www.emerson.com/en-us/support>).

Tie rod cylinder ISO 15552, Series TRB - inch

R480177190

TRB

2024-04-26

Dimensions

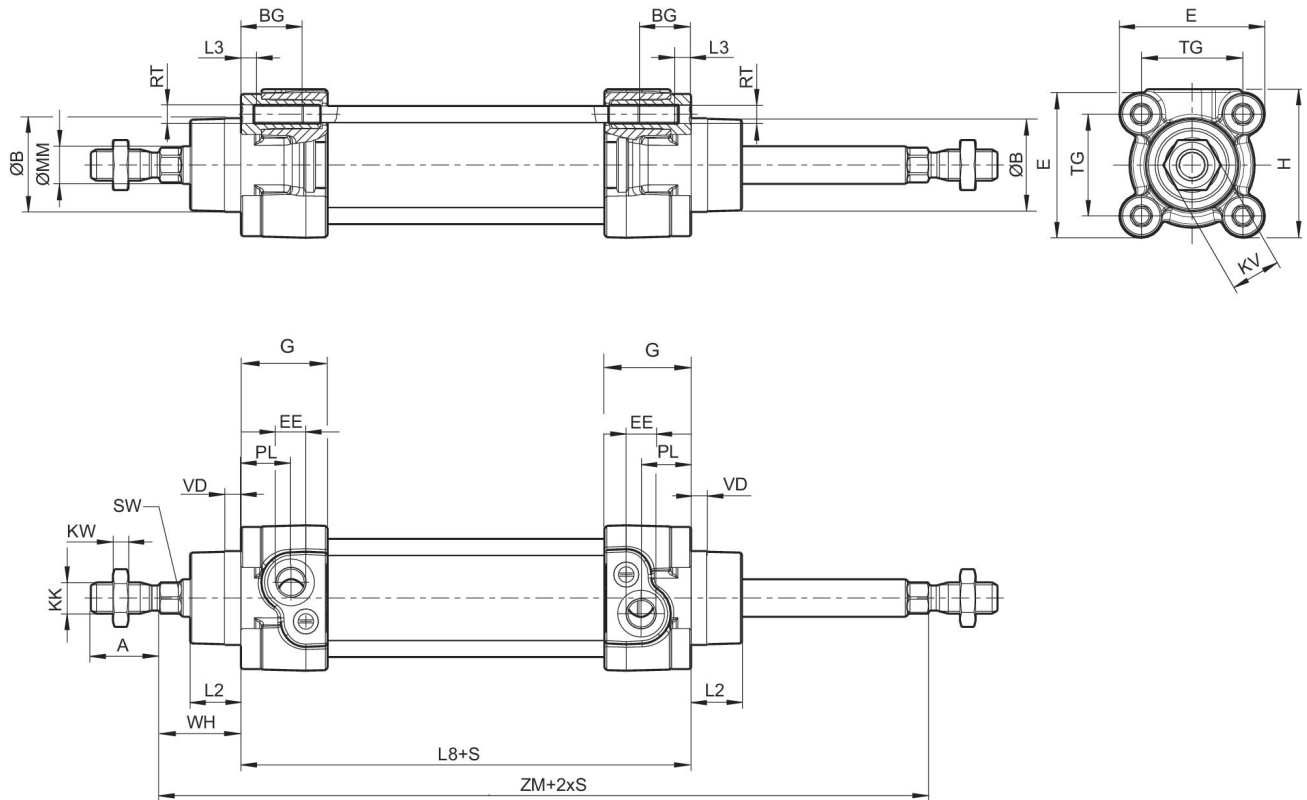

S = stroke

Dimensions in inches

Part No. Ø [mm]	Ø [inch]	A -0,08	ØB d11	BG min.	E	EE	KK	G	H
32	1 1/4	0.87	1.18	0.63	1.83	1/8 NPT	7/16 - 20 UNF	1.09	1.87
40	1 1/2	0.94	1.38	0.63	2.09	1/4 NPT	1/2 - 20 UNF	1.31	2.09
50	2	1.26	1.57	0.63	2.56	1/4 NPT	3/4 - 16 UNF	1.22	2.56
63	2 1/2	1.26	1.77	0.63	2.95	3/8 NPT	3/4 - 16 UNF	1.22	2.95
80	3	1.57	1.77	0.67	3.74	3/8 NPT	3/4 - 16 UNF	1.51	3.74
100	4	1.57	2.17	0.67	4.53	1/2 NPT	3/4 - 16 UNF	1.51	4.53
125	5	2.13	2.36	0.79	5.51	1/2 NPT	1 - 14 UNF	1.66	5.51

Part No. Ø [mm]	KV	KW	ØMM f8	PL	L2	L3 ±0,02	L8	RT	SW
32	0.63	0.2	0.47	0.63	0.64	0.18	3.7±0.02	M6	0.39
40	0.71	0.24	0.63	0.79	0.72	0.18	4.13±0.03	M6	0.51
50	0.94	0.31	0.79	0.75	0.98	0.18	4.17±0.03	M8	0.67
63	0.94	0.31	0.79	0.94	0.98	0.18	4.76±0.03	M8	0.67
80	1.18	0.39	0.98	0.93	1.3	0	5.04±0.03	M10	0.87
100	1.18	0.39	0.98	0.98	1.42	0	5.43±0.04	M10	0.87
125	1.61	0.53	1.26	1.3	1.77	0	6.3±0.04	M12	1.06

Tie rod cylinder ISO 15552, Series TRB - inch

R480177190

TRB

2024-04-26

Part No. Ø [mm]	TG	VD	WH	ZM
32	1.28±0.02	0.2	26±1.4	5.75+0.12/0.06
40	1.5±0.02	0.2	30±1.4	6.5+0.12/0.06
50	1.83±0.02	0.2	37±1.4	7.09+0.12/0.06
63	2.22±0.03	0.2	37±1.8	7.68+0.12/0.06
80	2.83±0.03	0.2	46±1.8	8.66+0.12/0.06
100	3.5±0.03	0.2	51±1.8	9.45+0.08/0.08
125	4.33±0.04	0.28	65±2.2	11.42+0.08/0.08

Cushioning diagram

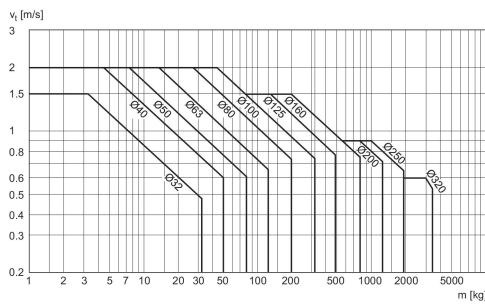

v_t = Piston velocity [m/s] m = Cushionable mass [kg]

Tie rod cylinder ISO 1552, Series TRB - inch

R480177190

TRB

2024-04-26

Overview drawing



NOTE: This overview drawing is only for orientation to indicate where the various accessory parts can be fastened to the cylinder. The illustration has been simplified for this purpose. It is thus not possible to derive the dimensions from this overview.