

Double piston cylinder, Series TWC-HL

R402000864

AVENTICS
Series TWC
Double
piston
cylinders

AVENTICS Series TWC Double piston cylinders

The AVENTICS Series TWC is a compact and powerful cylinder with its double piston offering also an high non-rotating accuracy.

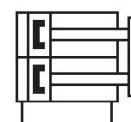
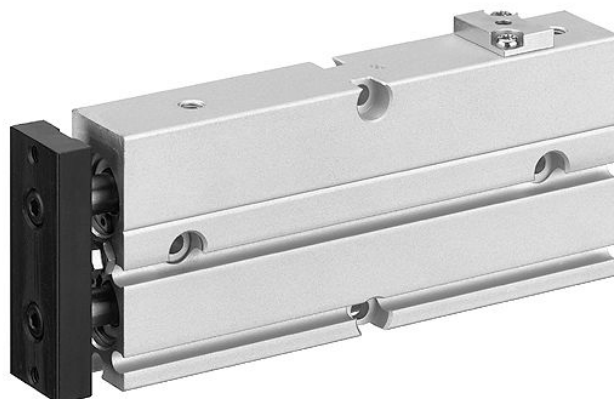

Technical data

Industry	Industrial
Piston Ø	25 mm
Stroke	30 mm
Port	M5
Functional principle	Double-acting
Magnetic piston	with magnetic piston
End position lock	retracted cylinder
Medium	Compressed air
Max. particle size	5 µm
Pressure for determining piston forces	6,3 bar
Cushioning	elastic
Min. ambient temperature	0 °C
Max. ambient temperature	60 °C
Min. oil content of compressed air	0 mg/m ³
Max. oil content of compressed air	1 mg/m ³
Min. working pressure	1.5 bar
Max. working pressure	7 bar
Retracting piston force	475 N
Extracting piston force	618 N
Max. speed	0.5 m/s
Max. holding force when locked	235 N
Max. play with locked end position	1 mm
Max. cushioning energy	0.23 J
Weight 10 mm stroke	0.64 kg
Weight +10 mm stroke	0.052 kg

Double piston cylinder, Series TWC-HL

R402000864

AVENTICS
Series TWC
Double
piston
cylinders

Max. play (radial) 0.6 °

2024-04-05

Material

Material, front cover	Steel, chrome-plated
Surface front cover	nickel-plated
Material of rear cover	Polyoxymethylene
Housing material	Aluminum
Surface housing	anodized
Material piston rod	Steel, chrome-plated
Surface piston rod	hardened
Material front plate	Steel, chrome-plated
Surface front plate	galvanized
Seal material	Acrylonitrile butadiene rubber
Material guide bushing	Aluminum
Surface guide bushing	anodized
Part No.	R402000864

Technical information

Additional function: end position lock with pressure drop

The pressure dew point must be at least 15 °C less than ambient and medium temperature and may not exceed 3 °C.

The oil content of compressed air must remain constant during the life cycle.

Use only the approved oils from AVENTICS. Further information can be found in the "Technical information" document (available in <https://www.emerson.com/en-us/support>).

Double piston cylinder, Series TWC-HL

R402000864

AVENTICS
Series TWC
Double
piston
cylinders

TWC 16-HL - 25-HL

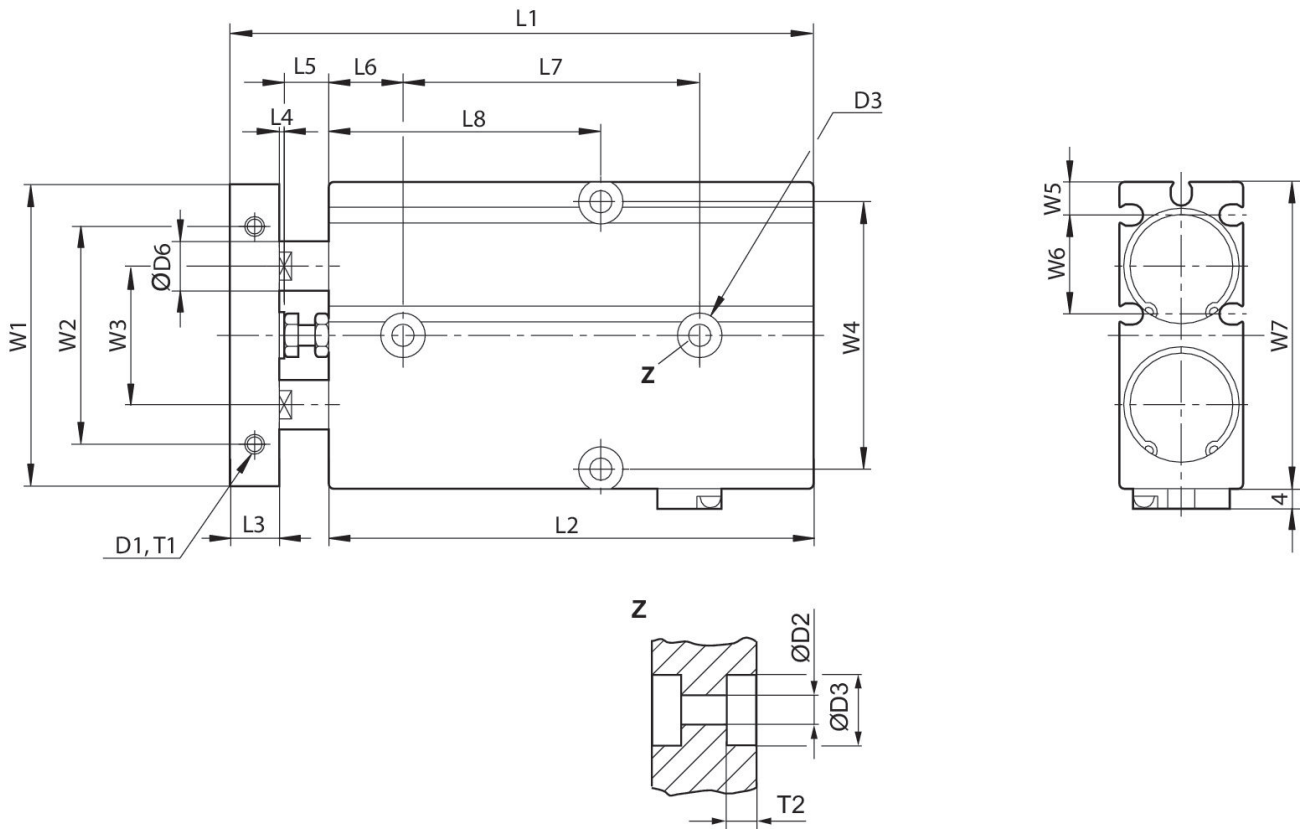

TWC 16-HL - 25-HL

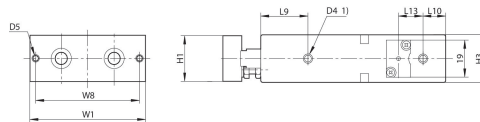

T1 = depth of thread

1) Compressed air connection

Piston Ø	D1	T1	Ø D2	Ø D3	T2	D4	D5	Ø D6	H1
16	2xM4	5	4,5	8	5,5	M5	2xM4	8	20
20	2xM4	5	4,5	8	5,5	M5	2xM4	10	24
25	2xM5	6	4,5	9	6	M5	2xM4	12	29

Piston Ø	H3	L1 ±0,8 1)	L2 ±0,2 S=10 2)	L2 ±0,2 S=20 2)	L2 ±0,2 S=30 2)	L2 ±0,2 S=40 2)	L2 ±0,2 S=50 2)	L2 ±0,2 S=60 2)	L2 ±0,2 S=70 2)
16	21	88	83	93	103	113	123	133	143
20	25	98	88	98	108	118	128	138	148
25	30	101	92	102	112	122	132	142	152

Piston Ø	L2 ±0,2 S=80 2)	L3	L4	L5	L6	L7 ±0,2 1)	L8 ±0,2 S=10 2)	L8 ±0,2 S=20 2)	L8 ±0,2 S=30 2)
16	153	8	1	6	15	40	40	45	50
20	158	10	1	9	15	40	40	45	50

Double piston cylinder, Series TWC-HL

R402000864

AVENTICS
Series TWC
Double
piston

Piston Ø	L2 ±0,2 S=80 2)	L3	L4	L5	L6	L7 ±0,2 1)	L8 ±0,2 S=10 2)	L8 ±0,2 S=20 2)	L8 ±0,2 S=30 2)
25	162	10	1	8	15	50	45	50	55

2024-04-05

Piston Ø	L8 ±0,2 S=40 2)	L8 ±0,2 S=50 2)	L8 ±0,2 S=60 2)	L8 ±0,2 S=70 2)	L8 ±0,2 S=80 2)	L9	L10	L13	W1
16	55	60	65	70	75	22	10	13	53
20	55	60	65	70	75	25	12	13	61
25	60	65	70	75	80	30	12	10	72

Piston Ø	W2 ±0,2	W3	W4 ±0,2	W5	W6	W7	W8 ±0,2
16	34	24	47	5.7	18.5	54	47
20	44	28	55	6.8	20	62	55
25	56	34	66	8.3	22.5	73	66

S = stroke

1) + Stroke

2) Dimensions for corresponding stroke