

Double piston cylinder, Series TWC

R402000830

AVENTICS
Series TWC
Double
piston
cylinders

AVENTICS Series TWC Double piston cylinders

The AVENTICS Series TWC is a compact and powerful cylinder with its double piston offering also an high non-rotating accuracy.

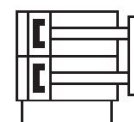
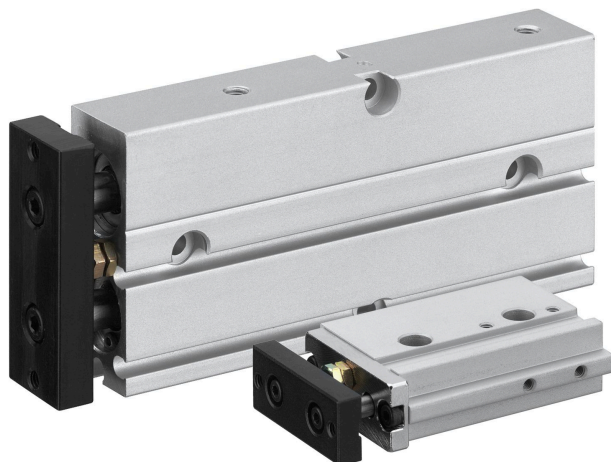

Technical data

Industry	Industrial
Piston Ø	25 mm
Stroke	50 mm
Port	M5
Functional principle	Double-acting
Magnetic piston	with magnetic piston
Medium	Compressed air
Max. particle size	5 µm
Pressure for determining piston forces	6,3 bar
Cushioning	elastic
Min. ambient temperature	0 °C
Max. ambient temperature	60 °C
Min. oil content of compressed air	0 mg/m ³
Max. oil content of compressed air	1 mg/m ³
Min. working pressure	1.5 bar
Max. working pressure	7 bar
Retracting piston force	475 N
Extracting piston force	618 N
Max. speed	0.5 m/s

Double piston cylinder, Series TWC

R402000830

AVENTICS
Series TWC
Double
piston
cylinders

2024-04-05

Max. retracted stroke setting	-5 mm
Max. cushioning energy	0.23 J
Weight 10 mm stroke	0.58 kg
Weight +10 mm stroke	0.051 kg
Max. play (radial)	0.6 °

Material

Material, front cover	Steel, chrome-plated
Surface front cover	nickel-plated
Material of rear cover	Polyoxymethylene
Housing material	Aluminum
Surface housing	anodized
Material piston rod	Steel, chrome-plated
Surface piston rod	hardened
Material front plate	Steel, chrome-plated
Surface front plate	galvanized
Seal material	Acrylonitrile butadiene rubber
Material guide bushing	Aluminum
Surface guide bushing	anodized
Part No.	R402000830

Technical information

The pressure dew point must be at least 15 °C less than ambient and medium temperature and may not exceed 3 °C.

The oil content of compressed air must remain constant during the life cycle.

Use only the approved oils from AVENTICS. Further information can be found in the "Technical information" document (available in <https://www.emerson.com/en-us/support>).

Double piston cylinder, Series TWC

R402000830

AVENTICS
Series TWC
Double
piston

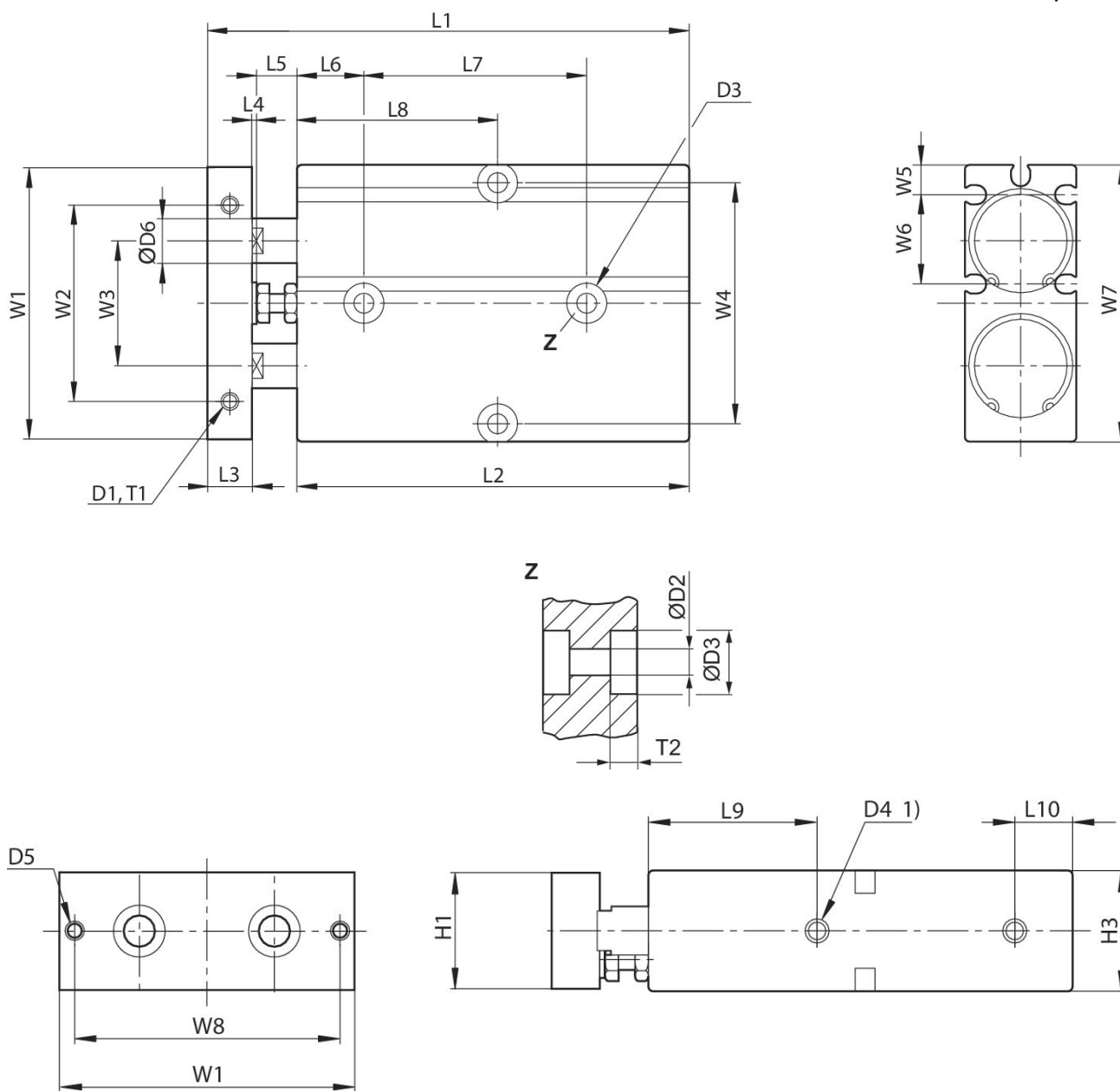

1) Compressed air connection
T1 = depth of thread

Piston Ø	D1	T1	Ø D2	Ø D3	T2	D4	D5	Ø D6	H1
6									
10	2xM3	4	3,4	6	5	M5	2xM3	6	16
16	2xM4	5	4,5	8	5,5	M5	2xM4	8	20
20	2xM4	5	4,5	8	5,5	M5	2xM4	10	24
25	2xM5	6	4,5	9	6	M5	2xM4	12	29
32	2xM8	10	5,5	9,5	10,5	G 1/8	2xM6	16	38

Double piston cylinder, Series TWC

R402000830

AVENTICS
Series TWC
Double
piston
cylinder

Piston Ø	H3	L1 ±0,8 1)	L2±0,2 S=10 2)	L2±0,2 S=20 2)	L2±0,2 S=30 2)	L2±0,2 S=40 2)	L2±0,2 S=50 2)	L2±0,2 S=60 2)	L2±0,2 S=70 2)
6									
10	17	68	66	76	86	96	106	116	126
16	21	78	73	83	93	103	113	123	133
20	25	88	78	88	98	108	118	128	138
25	30	91	82	92	102	112	122	132	142
32	40	118	98	108	118	128	138	148	158

Piston Ø	L2±0,2 S=80 2)	L2±0,2 S=90 2)	L2±0,2 S=100 2)	L3	L4	L5	L6	L7 ±0,2 1)	L8 ±0,2 S=10 2)
6									
10				5	1	6	15	25	25
16	143	153	163	8	1	6	15	30	40
20	148	158	168	10	1	9	15	30	45
25	152	162	172	10	1	8	15	40	50
32	168	178	188	17	1	12	17	45	55

Piston Ø	L8 ±0,2 S=20 2)	L8 ±0,2 S=30 2)	L8 ±0,2 S=40 2)	L8 ±0,2 S=50 2)	L8 ±0,2 S=60 2)	L8 ±0,2 S=70 2)	L8 ±0,2 S=80 2)	L8 ±0,2 S=90 2)	L8 ±0,2 S=100 2)
6									
10	40	45	50	55	60	65			
16	45	50	55	60	65	70	75	80	85
20	45	45	50	55	60	65	70	75	80
25	50	50	55	60	65	70	75	80	85
32	60	65	70	75	80	85	90	95	100

Piston Ø	L9	L10	W1	W2 ±0,2	W3	W4 ±0,2	W5	W6	W7
6									
10	32	10	41	26	18	34	5	14	42
16	32	10	53	34	24	47	5.7	18.5	54
20	35	12	61	44	28	55	6.8	20	62
25	40	12	72	56	34	66	8.3	22.5	73
32	46	15	94	72	42	83	10.1	34	96

Piston Ø	W8 ±0,2
6	
10	34
16	47
20	55
25	66
32	83

S = stroke
1) + Stroke

2) Dimensions for corresponding stroke

Double piston cylinder, Series TWC

R402000830

AVENTICS
Series TWC
Double
piston
cylinders

2024-04-05

Ø 10 ... 16

Max. transverse force F depending on the stroke length

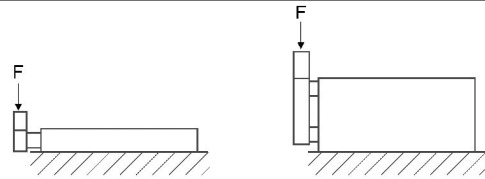
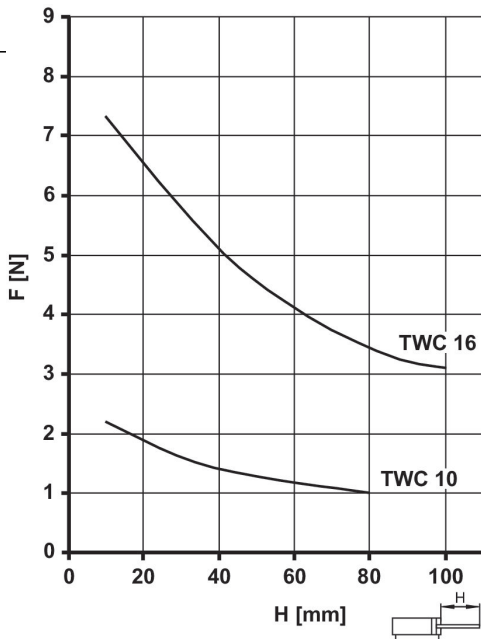

Ø 20 ... 32

Maximum permissible moving mass depending on the impact speed

