

AVENTICS Series 563/565/567 Directional valves

The AVENTICS Series 563/565/567 have an aluminium housing, and are suited for assembly on single or manifold subbases and offer flow rate performances of up to 13620 l/min with a working pressure of up to 30 bar.

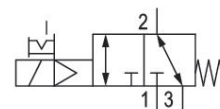

Technical data

Industry	Industrial
Activation	Electrically
Valve type	Poppet valve
Switching principle	3/2, with spring return
Valve function	NO/NC
Connection type	Plate connection
Manual override	with detent
Compressed air connection input	G 1
Nominal flow Qn	13620 l/min
Min. working pressure	3.5 bar
Max. working pressure	10 bar
Min. control pressure	3.5 bar
Max. control pressure	10 bar
Electrical connection type	Plug
Electrical connection size	EN 175301-803, form A

3/2-directional valve, Series 567

2023-11-13

5673011320

Protection class with connection	IP65
Operational voltage	110 V AC
Operational voltage AC at 60 Hz	110 V
Voltage tolerance AC 60 Hz	-10% / +10%

Pilot	External Internal
Holding power AC 60 Hz	16 VA
Switch-on power AC 60 Hz	26 VA

Duty cycle	100 %
------------	-------

Min. ambient temperature	-20 °C
Max. ambient temperature	50 °C
Min. medium temperature	-20 °C
Max. medium temperature	50 °C
Medium	Compressed air
Min. oil content of compressed air	0 mg/m ³
Max. oil content of compressed air	5 mg/m ³
Max. particle size	5 µm

Weight	2 kg
--------	------

Material

Housing material	Aluminum
Seal material	Acrylonitrile butadiene rubber
Part No.	5673011320

Technical information

Min./max. operating pressure for external pilot: -[[1] bar]/[[10] bar]

The valves can be energized via the port closed with a plug on the front side of the cover.

The size of the compressed air connection output for series 563, 565, 567 can vary due to optional use of the base plate. The base plate can be found under "Mechanical accessories".

The min. control pressure must be adhered to and should be equal or higher than the working pressure. Otherwise faulty switching and valve failure may result!

The pressure dew point must be at least 15 °C less than ambient and medium temperature and may not exceed 3 °C.

The oil content of compressed air must remain constant during the life cycle.

Use only the approved oils from AVENTICS. Further information can be found in the "Technical information" document (available in <https://www.emerson.com/en-us/support>).

3/2-directional valve, Series 567

2023-11-13

5673011320

Dimensions

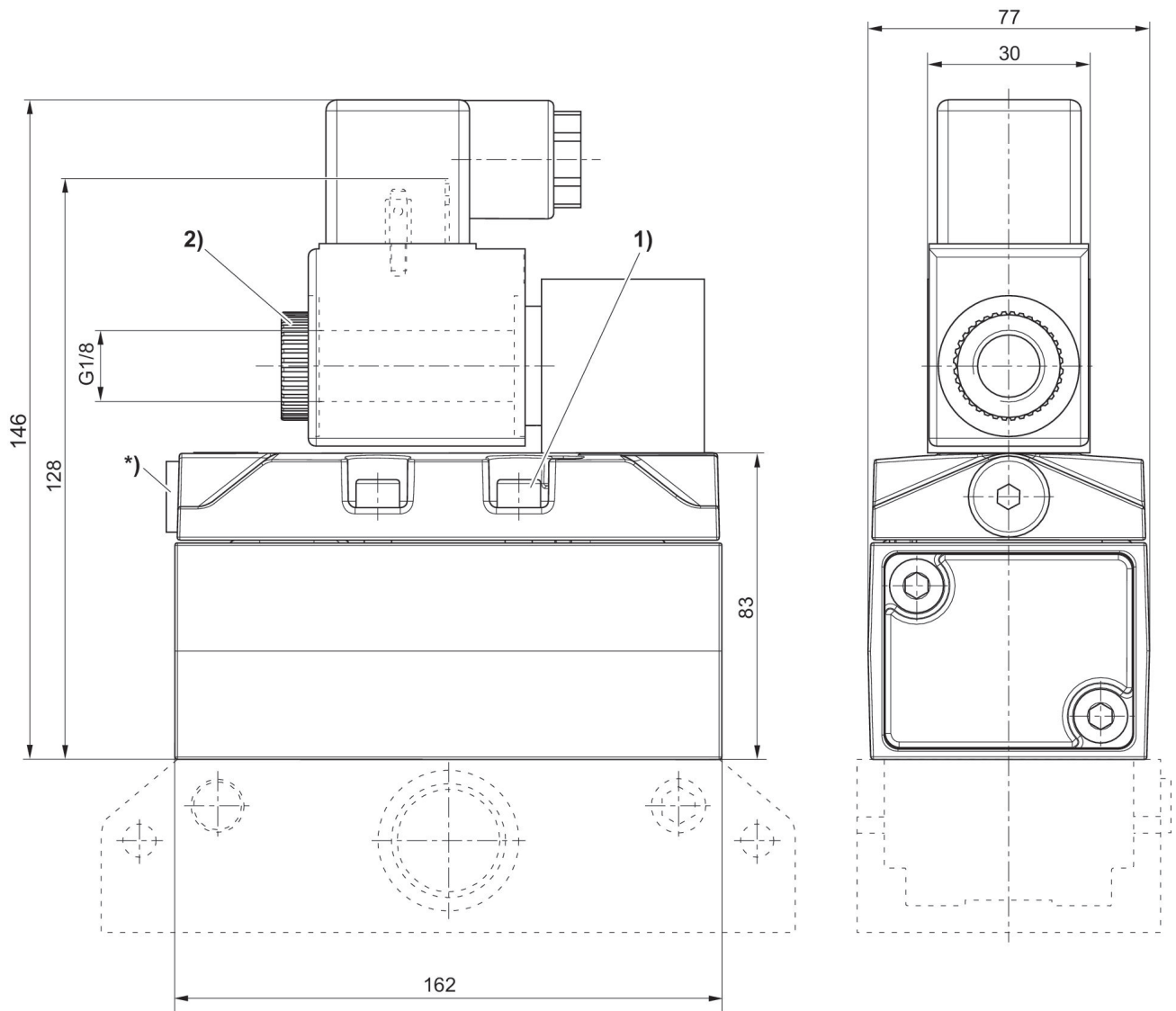

1) Tightening torque for mounting screws: 2.2 ± 0.2 Nm

2) Tightening torque for lock nut: 1 ± 0.2 Nm

* Plugged port G 1/8 for external pilot

Base plate not included in the scope of delivery