

5794400720

## AVENTICS Series 490/579/589 Directional Control Valves

The AVENTICS Series 490/579/589 have a robust polymer housing that can be mounted individually or as a block. They cover a large range of voltages and feature fast connections for pneumatic tubing.

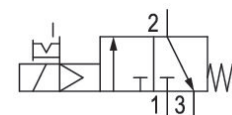

### Technical data

Industry	Industrial
Activation	Electrically
Valve type	Poppet valve
Switching principle	3/2, with spring return
Valve function	NC
Sealing principle	Soft seal
Connection type	Pipe connection
Manual override	with detent
Compressed air connection input	Ø 1/4"
Compressed air connection output	Ø 1/4"
Min. working pressure	2 bar
Max. working pressure	8 bar
Protection class with connection	IP65
Reverse polarity protection	Protected against polarity reversal
Operational voltage	24 V DC

# 3/2-directional valve, Series 579

2023-11-02

5794400720

---

Operational voltage DC	24 V
Voltage tolerance DC	-10% / +10%

Pilot	Internal
Coil width	20 mm
Power consumption DC	1.7 W

Duty cycle	100 %
Typ. switch-on time	18 ms
Typ. switch-off time	16 ms

Blocking principle	Single valve
Min. ambient temperature	-15 °C
Max. ambient temperature	50 °C
Min. medium temperature	-15 °C
Max. medium temperature	50 °C
Medium	Compressed air
Min. oil content of compressed air	0 mg/m <sup>3</sup>
Max. oil content of compressed air	1 mg/m <sup>3</sup>
Max. particle size	5 µm

Weight	0.093 kg
--------	----------

## Material

Housing material	Polyamide
Seal material	Acrylonitrile butadiene rubber Polyurethane
Part No.	5794400720

## Technical information

At an ambient temperature of [[40] °C] the max. working pressure is [[10] bar].

Versions with voltage of less than 50 V DC do not have a protective ground.

The min. control pressure must be adhered to, since otherwise faulty switching and valve failure may result!

The pressure dew point must be at least 15 °C less than ambient and medium temperature and may not exceed 3 °C.

The oil content of compressed air must remain constant during the life cycle.

Use only the approved oils from AVENTICS. Further information can be found in the "Technical information" document (available in <https://www.emerson.com/en-us/support>).

# 3/2-directional valve, Series 579

2023-11-02

5794400720

## Dimensions in inches

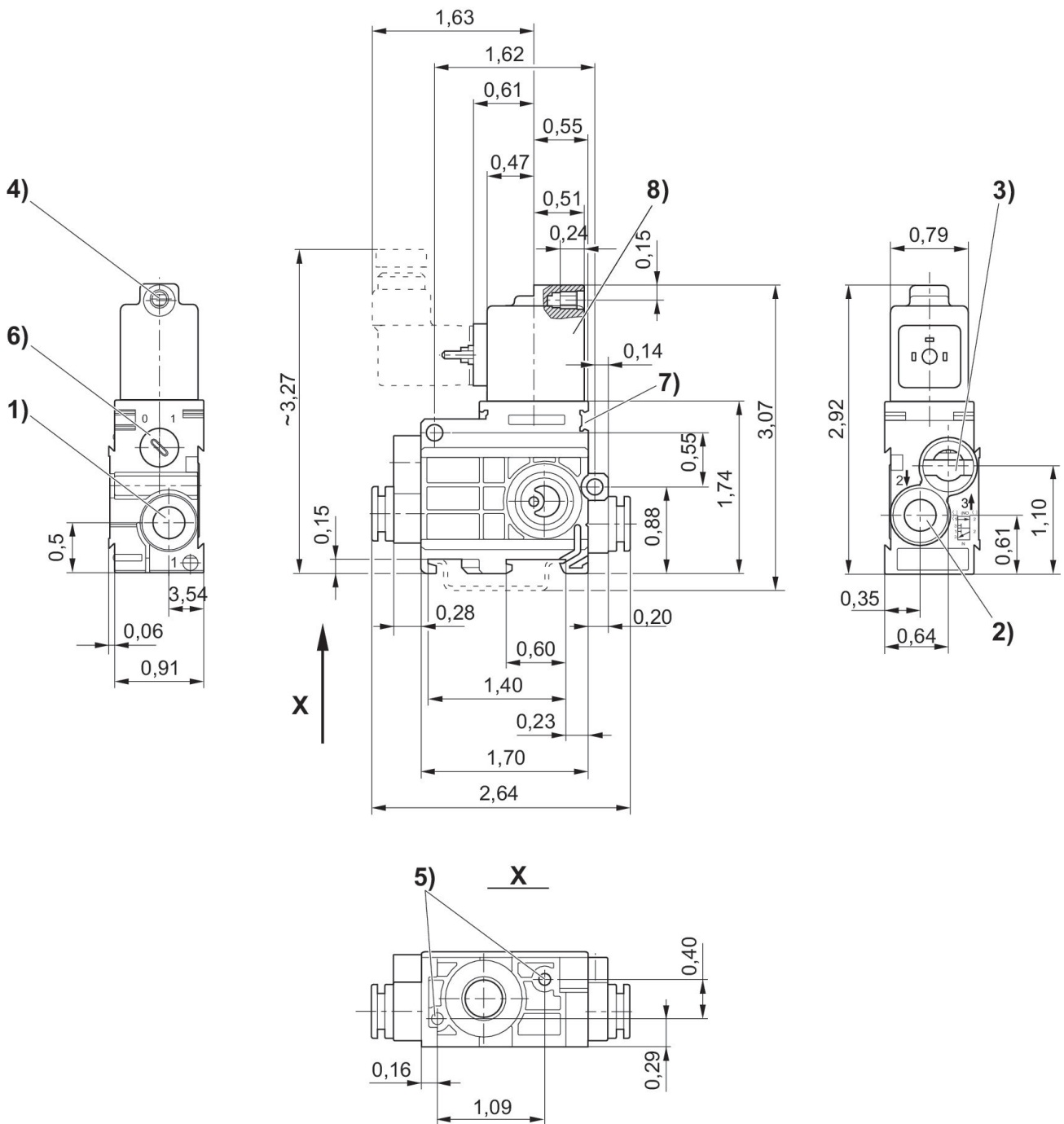

1) Port 1 2) Port 2 3) Port 3, core Ø for M5 4) Manual override 5) Pocket hole 6 mm deep for 3.5 self-tapping screw 6) Mounting space for name plate 7) Coil can be rotated at 180° intervals 8) Pilot valve