

AVENTICS Series 490/579/589 Directional Control Valves

The AVENTICS Series 490/579/589 have a robust polymer housing that can be mounted individually or as a block. They cover a large range of voltages and feature fast connections for pneumatic tubing.

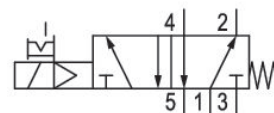

Technical data

Industry	Industrial
Activation	Electrically
Valve type	Poppet valve
Switching principle	5/2, with spring return
Sealing principle	Soft seal
Connection type	Pipe connection
Manual override	with detent
Compressed air connection input	Ø 1/4"
Compressed air connection output	Ø 1/4"
Min. working pressure	2 bar
Max. working pressure	8 bar
Protection class with connection	IP65
Reverse polarity protection	Protected against polarity reversal
Operational voltage	24 V DC
Operational voltage DC	24 V

5/2-directional valve, Series 579

2023-11-02

5794700720

Voltage tolerance DC -10% / +10%

Pilot Internal

Coil width 20 mm

Power consumption DC 1.7 W

Duty cycle 100 %

Typ. switch-on time 27 ms

Typ. switch-off time 28 ms

Blocking principle Single valve

Min. ambient temperature -15 °C

Max. ambient temperature 50 °C

Min. medium temperature -15 °C

Max. medium temperature 50 °C

Medium Compressed air

Min. oil content of compressed air 0 mg/m³

Max. oil content of compressed air 1 mg/m³

Max. particle size 5 µm

Weight 0.133 kg

Material

Housing material Polyamide
Polyurethane

Part No. 5794700720

Technical information

At an ambient temperature of [[40] °C] the max. working pressure is [[10] bar].

Versions with voltage of less than 50 V DC do not have a protective ground.

The min. control pressure must be adhered to, since otherwise faulty switching and valve failure may result!

The pressure dew point must be at least 15 °C less than ambient and medium temperature and may not exceed 3 °C.

The oil content of compressed air must remain constant during the life cycle.

Use only the approved oils from AVENTICS. Further information can be found in the "Technical information" document (available in <https://www.emerson.com/en-us/support>).

5/2-directional valve, Series 579

2023-11-02

5794700720

Dimensions

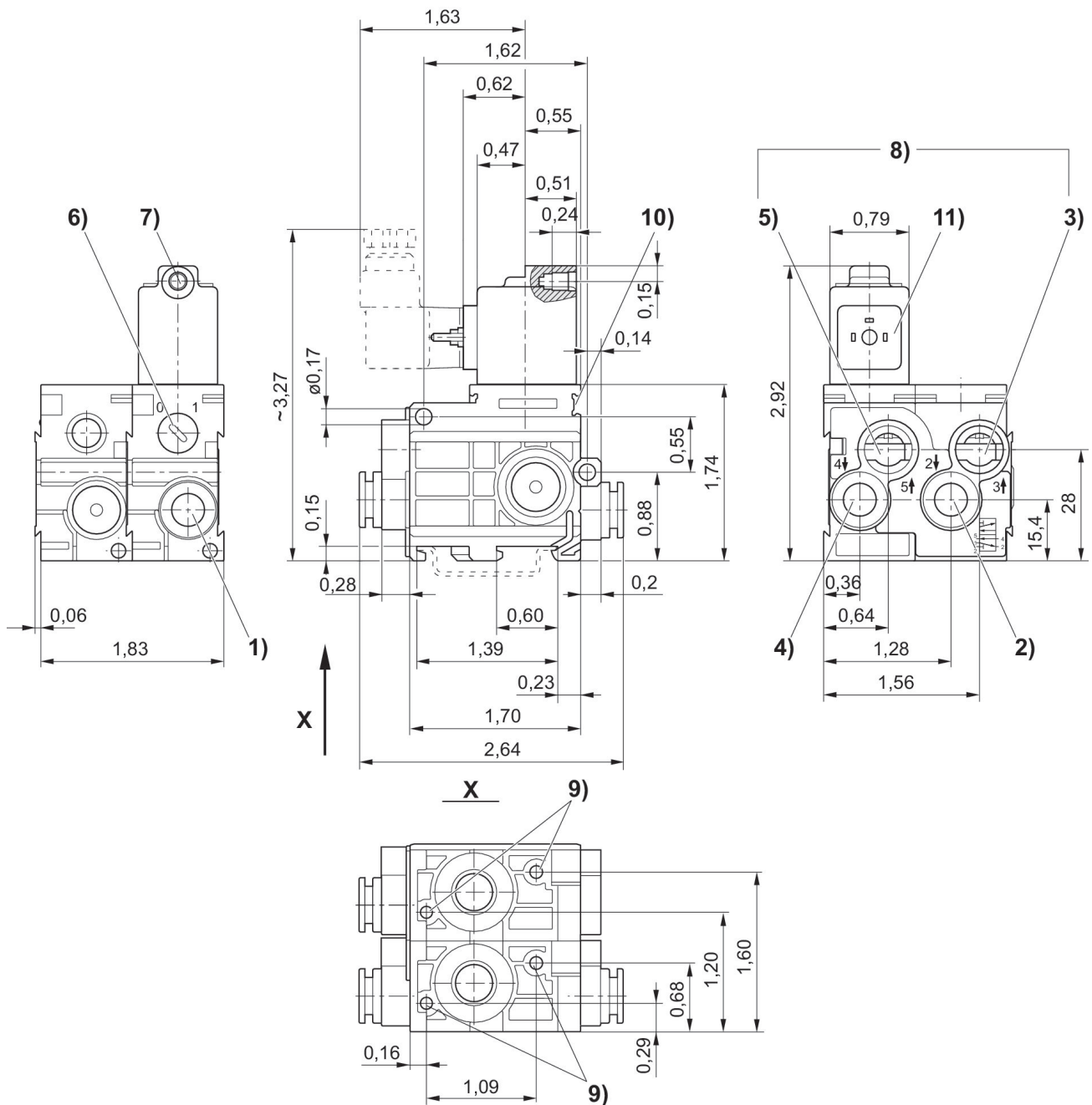

1) port 1 2) port 2 3) port 3 4) port 4 5) port 5 6) manual override 7) core Ø for M 5 8) exhaust air must not be throttled 9) pocket hole 6 mm deep for 3.5 self-tapping screw 10) mounting space for name plate 11) coil can be rotated at 180° intervals