

# 5/2-directional valve, Series 581, size 2

## 5812611200

ISO 5599-1, size 2, series 581

■  $Q_n = 2100 \dots 2700$  l/min

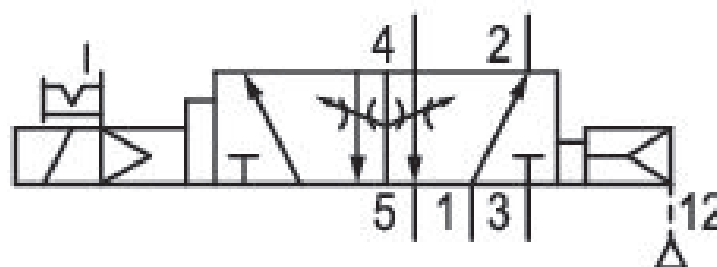

### Technical data

Industry  
Industrial

Activation  
Electrically

Nominal flow  $Q_n$   
2700 l/min

Switching principle  
5/2

Compressed air connection output  
Base plate ISO 5599-1

Working pressure min.  
2.7 bar

Working pressure max  
10 bar

Operational voltage AC at 50 Hz  
24 V

Voltage tolerance AC 50 Hz  
-10% / +10%

Manual override  
with detent

Electrical connection type  
Plug

Electrical connection size  
Form B, industry

Sealing principle  
Soft Seal

Pilot  
Internal

<b>Standards</b> ISO 5599-1	<b>Max. ambient temperature</b> 50 °C
<b>Pilot valve width</b> 22 mm	<b>Min. medium temperature</b> -15 °C
<b>Valve type</b> Spool valve	<b>Max. medium temperature</b> 50 °C
<b>Blocking principle</b> Single base plate principle	<b>Medium</b> Compressed air
<b>Connection type</b> Plate connection	<b>Max. particle size</b> 50 µm
<b>Return</b> with air spring return	<b>Oil content of compressed air min.</b> 0 mg/m <sup>3</sup>
<b>Compressed air connection input</b> Base plate ISO 5599-1	<b>Oil content of compressed air max.</b> 5 mg/m <sup>3</sup>
<b>Compressed air connection, exhaust</b> Base plate ISO 5599-1	<b>Protection class with connection</b> IP65
<b>Compressed air connection pilot exhaust</b> M5	<b>Duty cycle</b> 100 %
<b>Holding power AC 50 Hz</b> 8 VA	<b>Typ. switch-on time</b> 12 ms
<b>Switch-on power AC 50 Hz</b> 10 VA	<b>Typ. switch-off time</b> 41 ms
<b>Flow conductance C</b> 10.8 l/(s*bar)	<b>mounting screws</b> with hexagon socket
<b>Throttle</b> with throttle	<b>Mounting screw tightening torque</b> 3.5 Nm
<b>Frame size</b> ISO 2	<b>Weight</b> 0.34 kg
<b>Control pressure min.</b> 2.7 bar	<b>Housing material</b> Polyamide fiber-glass reinforced
<b>Control pressure max.</b> 10 bar	<b>Seal material</b> Acrylonitrile butadiene rubber
<b>Min. ambient temperature</b> -15 °C	<b>Part No.</b> 5812611200

## Technical information

The min. control pressure must be adhered to, since otherwise faulty switching and valve failure may result!

The pressure dew point must be at least 15 °C under ambient and medium temperature and may not exceed 3 °C .

The oil content of compressed air must remain constant during the life cycle.

Use only the approved oils from AVENTICS. Further information can be found in the “Technical information” document (available in <https://www.emerson.com/en-us/support>).

## Dimensions

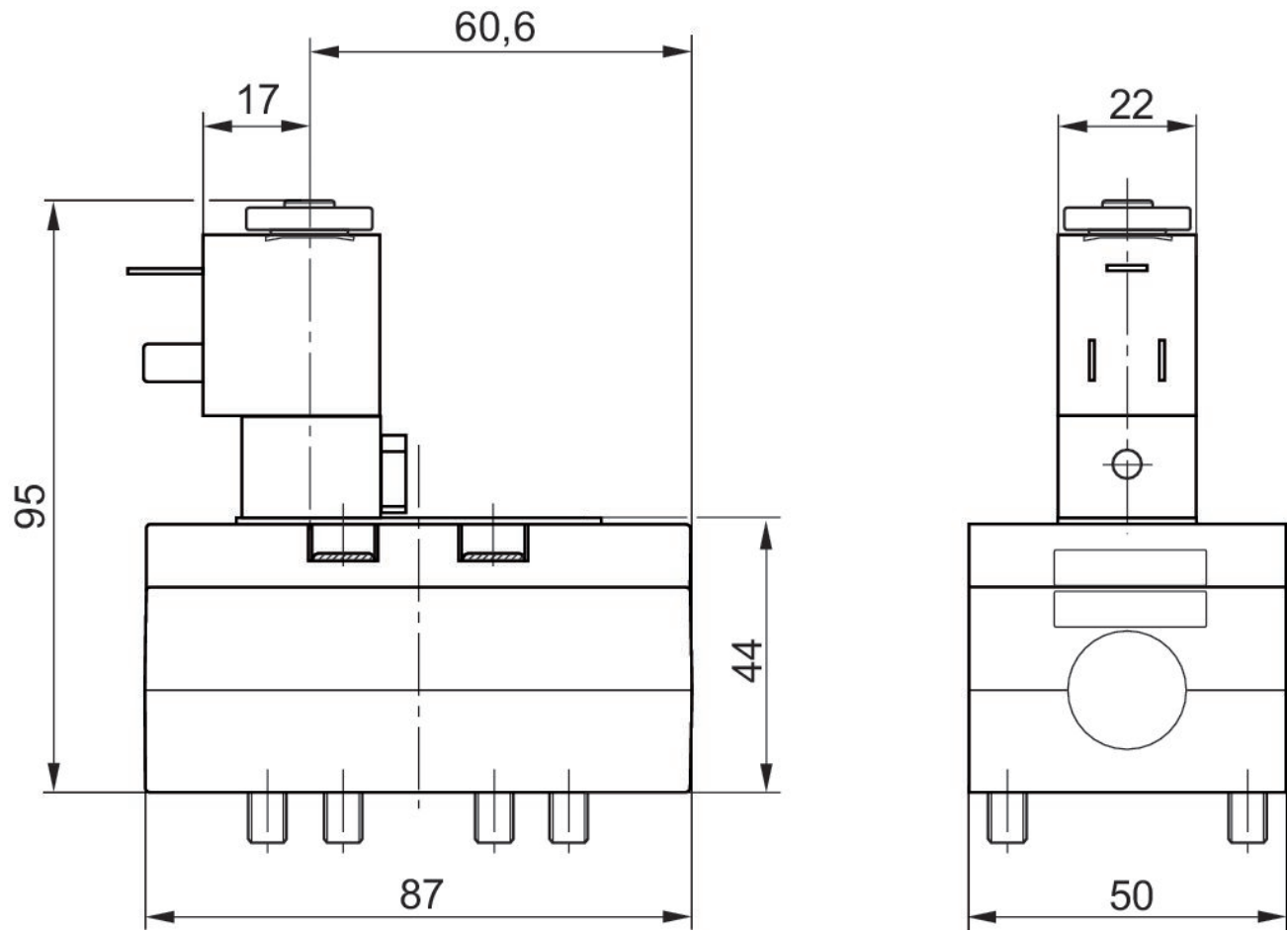

The pilot valves can be loosened and turned through 180°.