

5/2-directional valve, Series 581, size 2

5812611100

ISO 5599-1, size 2, series 581

■ $Q_n = 2100 \dots 2700$ l/min

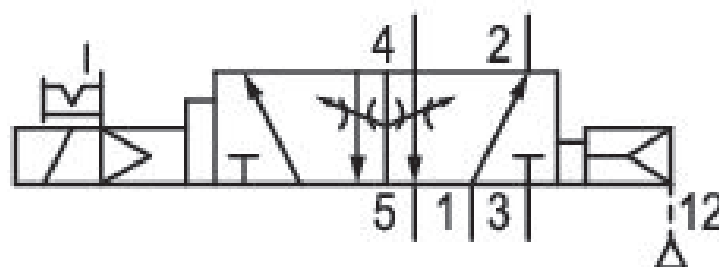

Technical data

Industry
Industrial

Activation
Electrically

Nominal flow Q_n
2700 l/min

Switching principle
5/2

Compressed air connection output
Base plate ISO 5599-1

Working pressure min.
2.7 bar

Working pressure max
10 bar

DC operating voltage
24 V

Voltage tolerance DC
-10% / +10%

Manual override
with detent

Electrical connection type
Plug

Electrical connection size
Form B, industry

Sealing principle
Soft Seal

Pilot
Internal

Standards ISO 5599-1	Min. medium temperature -15 °C
Pilot valve width 22 mm	Max. medium temperature 50 °C
Valve type Spool valve	Medium Compressed air
Blocking principle Single base plate principle	Max. particle size 50 µm
Connection type Plate connection	Oil content of compressed air min. 0 mg/m ³
Return with air spring return	Oil content of compressed air max. 5 mg/m ³
Compressed air connection input Base plate ISO 5599-1	Protection class with connection IP65
Compressed air connection, exhaust Base plate ISO 5599-1	Duty cycle 100 %
Compressed air connection pilot exhaust M5	Typ. switch-on time 12 ms
Power consumption DC 5 W	Typ. switch-off time 41 ms
Flow conductance C 10.8 l/(s*bar)	mounting screws with hexagon socket
Throttle with throttle	Mounting screw tightening torque 3.5 Nm
Frame size ISO 2	Weight 0.34 kg
Control pressure min. 2.7 bar	Housing material Polyamide fiber-glass reinforced
Control pressure max. 10 bar	Seal material Acrylonitrile butadiene rubber
Min. ambient temperature -15 °C	Part No. 5812611100
Max. ambient temperature 50 °C	

Technical information

The min. control pressure must be adhered to, since otherwise faulty switching and valve failure may result!

The pressure dew point must be at least 15 °C under ambient and medium temperature and may not exceed 3 °C .

The oil content of compressed air must remain constant during the life cycle.

Use only the approved oils from AVENTICS. Further information can be found in the “Technical information” document (available in <https://www.emerson.com/en-us/support>).

Dimensions

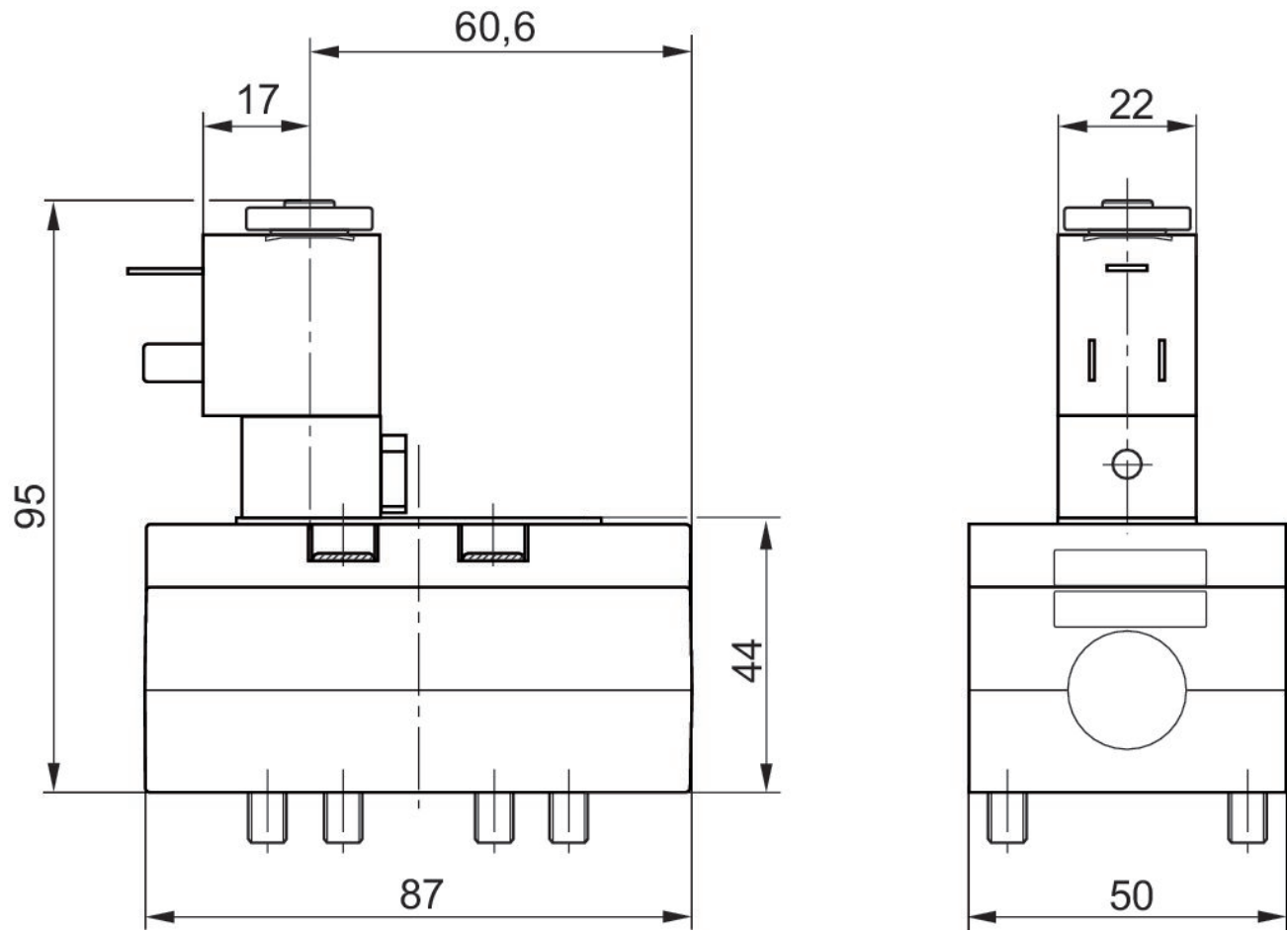

The pilot valves can be loosened and turned through 180°.