

5811110200

- $Q_n = 950 \dots 1400$ l/min

AVENTICS Series 581 - Size 1 Standardized valves

The AVENTICS series 581 complies with the ISO 5599-1 valve standard. Due to the high degree of modularity, the series offers all valve functions, integrated throttle valves, various pilot coils and an extensive range of accessories.

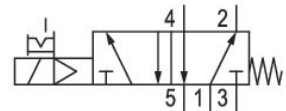

Technical data

Industry	Industrial
Activation	Electrically
Nominal flow Q_n	1400 l/min
Switching principle	5/2, with spring return
Compressed air connection output	Base plate ISO 5599-1
Min. working pressure	3 bar
Max. working pressure	10 bar
Operational voltage	24 V AC
Operational voltage AC at 50 Hz	24 V
Voltage tolerance AC 50 Hz	-10% / +10%
Manual override	with detent
Electrical connection type	Plug
Electrical connection size	Form B, industry
Actuating control	Single Solenoid
Sealing principle	Soft seal
Pilot	Internal
Standards	ISO 5599-1
Pilot valve width	22 mm
Valve type	Spool valve

5811110200

Blocking principle	Single base plate principle
Connection type	Plate connection
Return	With spring return
Compressed air connection input	Base plate ISO 5599-1
Compressed air connection, exhaust	Base plate ISO 5599-1
Compressed air connection pilot exhaust	M5
Holding power AC 50 Hz	8 VA
Switch-on power AC 50 Hz	10 VA
Flow conductance C	5.2 l/(s*bar)
Frame size	ISO 1
Min. control pressure	3 bar
Max. control pressure	10 bar
Min. ambient temperature	-15 °C
Max. ambient temperature	50 °C
Min. medium temperature	-15 °C
Max. medium temperature	50 °C
Medium	Compressed air
Max. particle size	50 µm
Min. oil content of compressed air	0 mg/m ³
Max. oil content of compressed air	5 mg/m ³
Protection class with connection	IP65
Duty cycle	100 %
Typ. switch-on time	12 ms
Typ. switch-off time	28 ms
Mounting screws	with hexagon socket
Mounting screw tightening torque	2 Nm
Weight	0.23 kg
Housing material	Polyamide fiber-glass reinforced
Seal material	Acrylonitrile butadiene rubber
Part No.	5811110200

Technical information

The min. control pressure must be adhered to, since otherwise faulty switching and valve failure may result!

The pressure dew point must be at least 15 °C less than ambient and medium temperature and may not exceed 3 °C.

The oil content of compressed air must remain constant during the life cycle.

Use only the approved oils from AVENTICS. Further information can be found in the "Technical information" document (available in <https://www.emerson.com/en-us/support>).

5/2-directional valve, Series 581, size 1

2023-11-28

5811110200

Dimensions

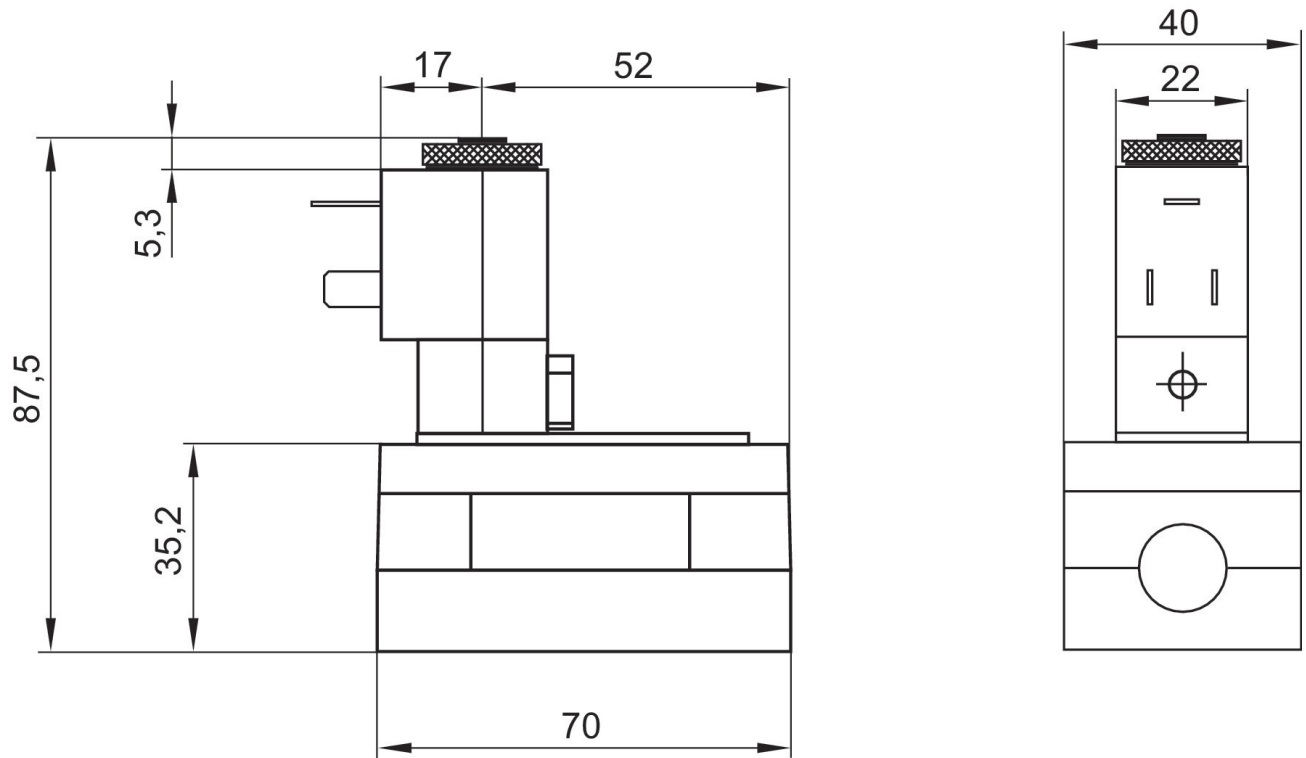

The pilot valves can be loosened and turned through 180°.