

5/2-directional valve, Series 581, size 2

5812112400

ISO 5599-1, size 2, series 581

■ $Q_n = 2100 \dots 2700$ l/min

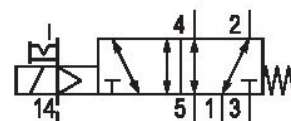

Technical data

Industry
Industrial

Activation
Electrically

Nominal flow Q_n
2700 l/min

Switching principle
5/2

Compressed air connection output
Base plate ISO 5599-1

Working pressure min.
-0.95 bar

Working pressure max
10 bar

Operational voltage AC at 50 Hz
230 V

Voltage tolerance AC 50 Hz
-10% / +10%

Manual override
with detent

Electrical connection type
Plug

Electrical connection size
Form B, industry

Actuating control
Single Solenoid

Sealing principle
Soft Seal

Pilot
External

Standards
ISO 5599-1

Pilot valve width
22 mm

Valve type
Spool valve

Blocking principle Single base plate principle	Max. medium temperature 50 °C
Connection type Plate connection	Medium Compressed air
Return With spring return	Max. particle size 50 µm
Compressed air connection input Base plate ISO 5599-1	Oil content of compressed air min. 0 mg/m ³
Compressed air connection, exhaust Base plate ISO 5599-1	Oil content of compressed air max. 5 mg/m ³
Compressed air connection pilot exhaust M5	Protection class with connection IP65
Holding power AC 50 Hz 8 VA	Duty cycle 100 %
Switch-on power AC 50 Hz 10 VA	Typ. switch-on time 15 ms
Flow conductance C 10.8 l/(s*bar)	Typ. switch-off time 46 ms
Frame size ISO 2	mounting screws with hexagon socket
Control pressure min. 3 bar	Mounting screw tightening torque 3.5 Nm
Control pressure max. 10 bar	Weight 0.34 kg
Min. ambient temperature -15 °C	Housing material Polyamide fiber-glass reinforced
Max. ambient temperature 50 °C	Seal material Acrylonitrile butadiene rubber
Min. medium temperature -15 °C	Part No. 5812112400

Technical information

The min. control pressure must be adhered to, since otherwise faulty switching and valve failure may result!

The pressure dew point must be at least 15 °C under ambient and medium temperature and may not exceed 3 °C .

The oil content of compressed air must remain constant during the life cycle.

Use only the approved oils from AVENTICS. Further information can be found in the “Technical information” document (available in <https://www.emerson.com/en-us/support>).

Dimensions

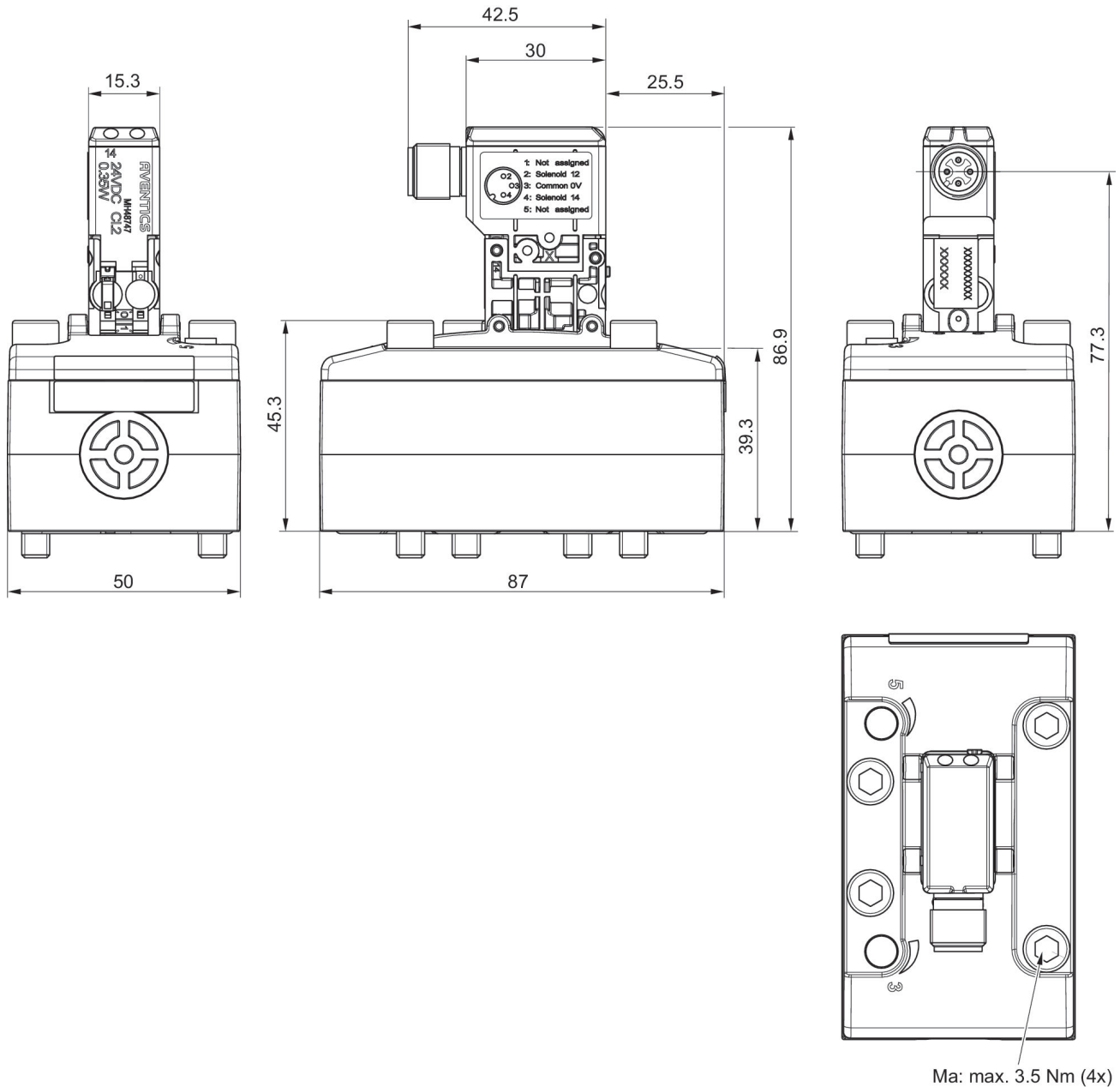

Dimensions

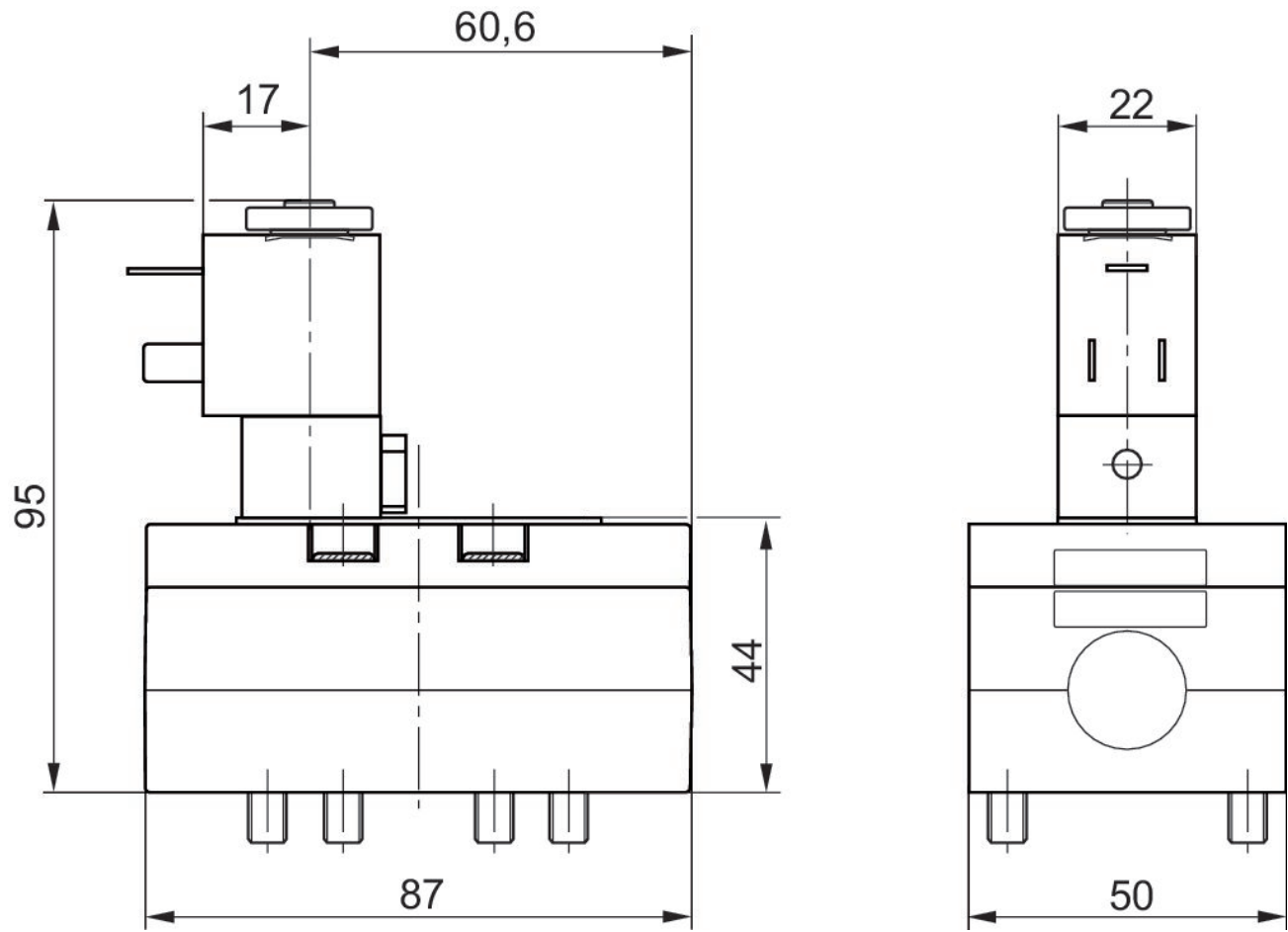

The pilot valves can be loosened and turned through 180°.

Pin assignments

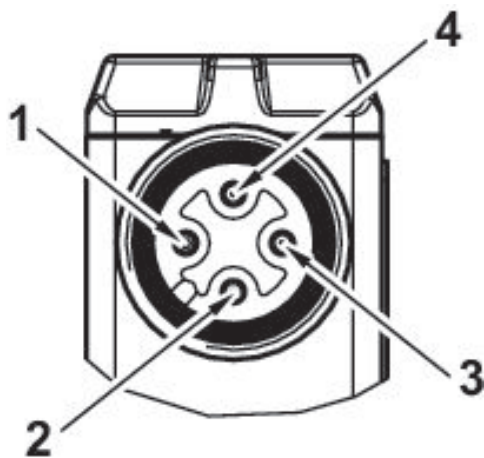

- 1) not assigned
- 2) Coil 12
- 3) 0 V DC
- 4) Coil 14