

# 5/3-directional valve, Series 581, size 3

581, size 3

5813441000

2023-12-18

## ISO 5599-1, series 581, size 3

Qn = 1400 l/min

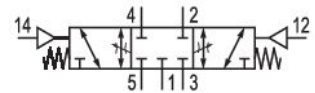

## Technical data

Industry	Industrial
Activation	Pneumatically
Switching principle	5/3, closed center
Connection type	Plate connection
Nominal flow Qn	4100 l/min
Compressed air connection output	Base plate ISO 5599-1
Min. working pressure	-0.95 bar
Max. working pressure	16 bar
Sealing principle	Soft seal
Standards	ISO 5599-1
Valve type	Spool valve
Version	ISO 3
Throttle	with throttle
Can be assembled into blocks	Can be assembled into blocks
Blocking principle	Single base plate principle
Min. control pressure	3 bar
Max. control pressure	16 bar
Min. ambient temperature	-20 °C
Max. ambient temperature	70 °C
Min. medium temperature	-20 °C
Max. medium temperature	70 °C
Medium	Compressed air
Max. particle size	50 µm
Min. oil content of compressed air	0 mg/m <sup>3</sup>

# 5/3-directional valve, Series 581, size 3

581, size 3

5813441000

2023-12-18

Max. oil content of compressed air	5 mg/m <sup>3</sup>
version pneumatic port	Closed Center
Compressed air connection input	Base plate ISO 5599-1
Flow conductance C	14.1 l/(s*bar)
Mounting screw	with hexagon socket
Mounting screw tightening torque	10 Nm
Weight	0.85 kg
Housing material	Aluminum
Seal material	Acrylonitrile butadiene rubber
Part No.	5813441000

## Technical information

The min. control pressure must be adhered to, since otherwise faulty switching and valve failure may result!

The pressure dew point must be at least 15 °C less than ambient and medium temperature and may not exceed 3 °C.

The oil content of compressed air must remain constant during the life cycle.

Use only the approved oils from AVENTICS. Further information can be found in the "Technical information" document (available in <https://www.emerson.com/en-us/support>).

Fig. 1

Hole pattern for logic modules

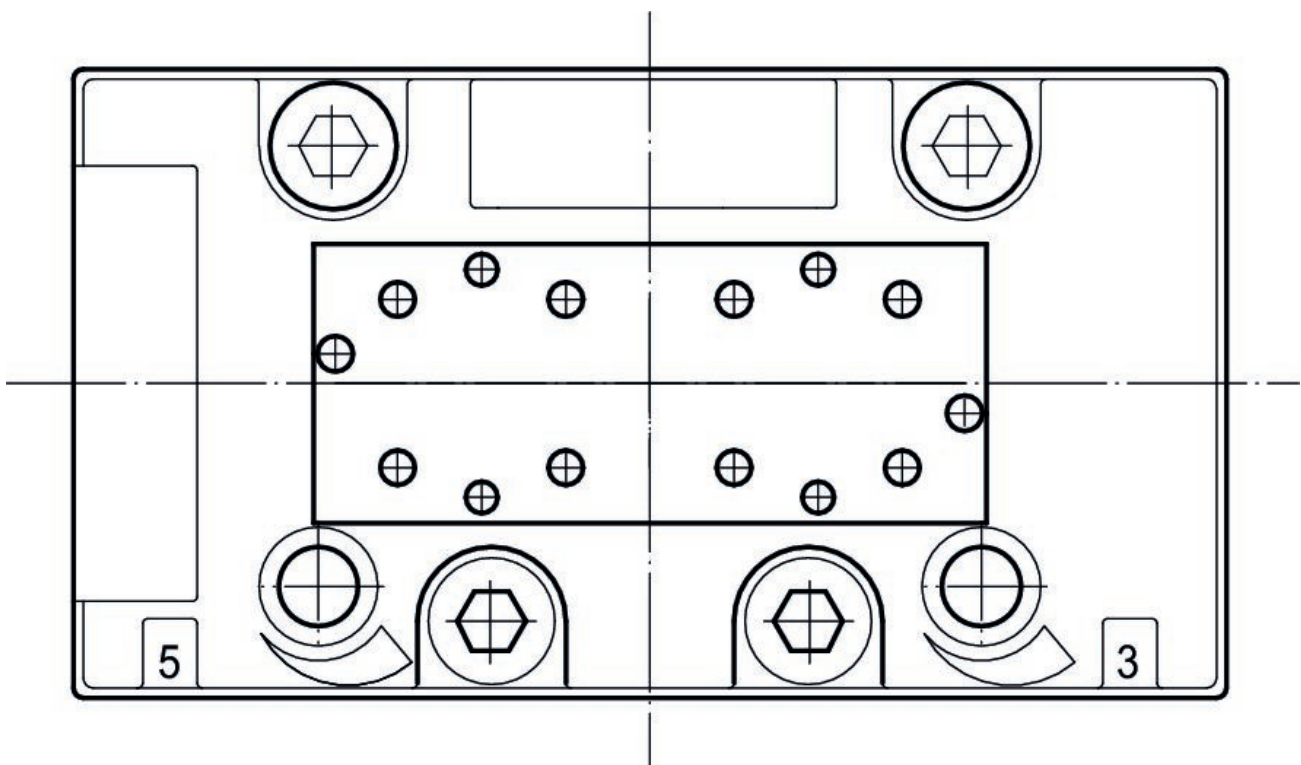

# 5/3-directional valve, Series 581, size 3

581, size 3

5813441000

2023-12-18

## Dimensions

