

AVENTICS Series Easy-2-Combine Interface

The AVENTICS Easy-2-Combine standardized mounting interface with interlocking connections make it possible to combine the mini slide, rodless cylinders and rotary modules into multi-axis systems without additional connection plates. This simplifies machine design and construction and saves time and money.

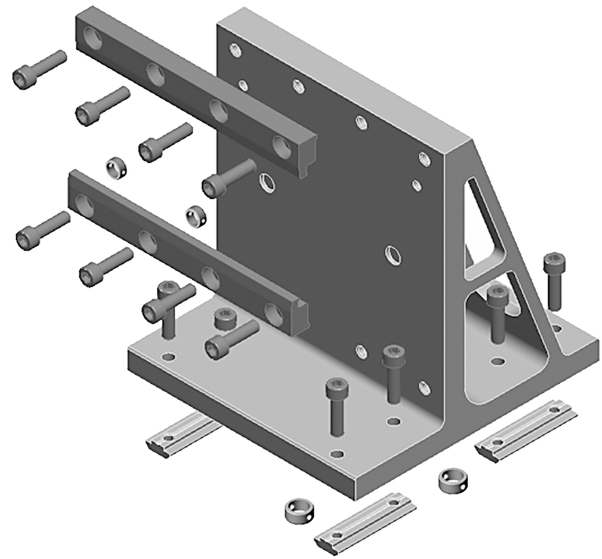

Technical data

Industry

Industrial

For series

CKP

CKP

Easy2Combine basic

CKP-32

Easy2Combine add-on part

CKP-32

Weight

2.8 kg

Material

Material centering sleeve

Stainless Steel

Connection plate material

Aluminum

Screws material

Steel, chrome-plated

Part No.

R039110258

Y-axis connected by the carriage (profile travels)

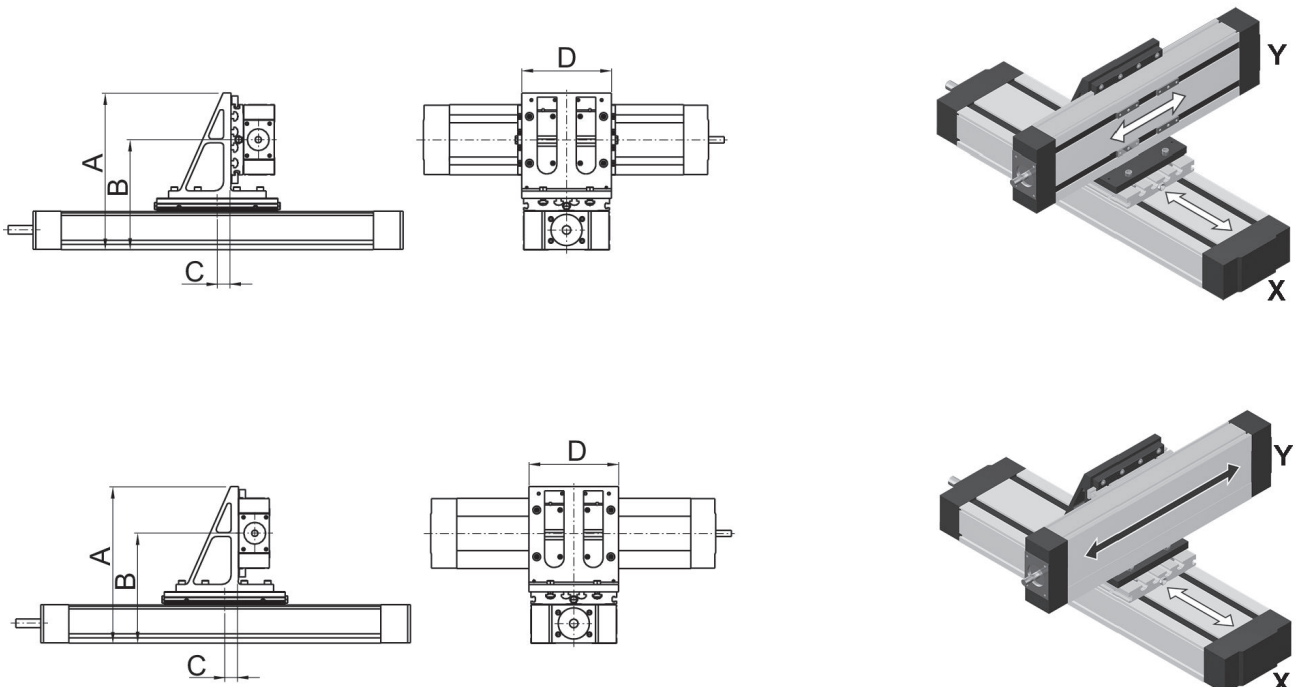

Part No.	X 1)	Y 2)	X/Y A	X/Y B	X/Y C	D	m [kg]
R039110255	CKP-16 CKP-25	CKP-16	191 201	131 141	17.5	115	1.1
R039110256	CKP-25	CKP-25	226.5	152	18.5	145	1.5
R039110326	CKP-32	CKP-25	248	176	21	145	2.1
R039110258	CKP-32	CKP-32	286	193.5	21	175	2.8

1) basic
2) add-on-part
m = mass