

Solenoid valves MHJ, fast-switching valves, NPT

FESTO

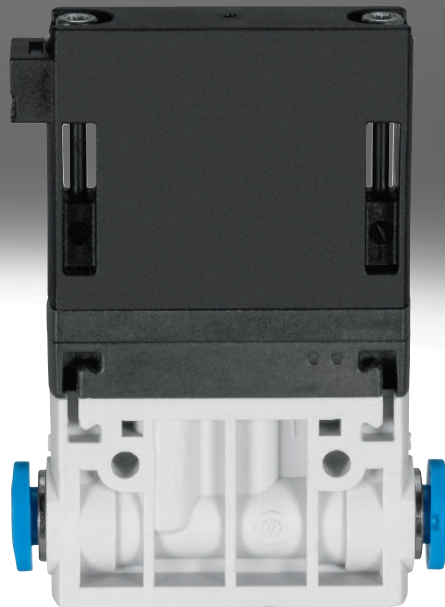

Key features



Innovative

- Individual electrical connection via moulded-in cable, control electronics included in the valve
- Switching times of less than one millisecond
- Signal control range 3 ... 30 V DC

Reliable

- Reliable servicing thanks to valves that can be replaced quickly and easily
- No electrical plug connections thanks to integrated control electronics
- Up to 5 billion switching cycles

MHJ10

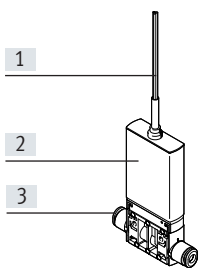

[1] Connecting cables

[2] In-line valve

[3] Push-in connector

In-line valve

- Integrated quick push-in connector
- Electrical connection with moulded-in connecting cable

Integrated control electronics

- Compact design
- Quick installation

Product range overview

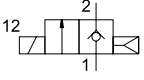
Function	Design	Operating voltage [V DC]	Type	Electrical connection	Switching time ¹⁾		→ Page/Internet
					Off	On	
2/2-way valve 	MF = Standard nominal flow rate 100 l/min						
	In-line valve	24	MHJ10	With moulded-in cable	0.4	0.8	5
	HF/LP = Standard nominal flow rate 160 l/min						
	In-line valve	24	MHJ10	With moulded-in cable	0.5	1	5
	HF = Standard nominal flow rate 160 l/min						
	In-line valve	24	MHJ10	With moulded-in cable	0.6	1.2	5

1) Switching time at 24 V DC and 4 bar

Type codes

001	Series
MHJ9	Solenoid valve
MHJ10	Solenoid valve

002	Control electronics
	Without integrated control electronics (only with MHJ9)
S	With integrated control electronics (only with MHJ10)

003	Cable length
	Without integrated cable
2,5	2.5 m
0,35	0.35 m

004	Pneumatic connection
	Sub-base valves
QS-4	Push-in connector 4 mm
QS-6	Push-in connector 6 mm
QS-1/4	Push-in connector 1/4



005	Flow rate
LF	50 l/min
MF	100 l/min
MF/LP	100 l/min, 0.5 ... 4 bar
HF	160 l/min
HF/LP	160 l/min, 0.5 ... 4 bar

006	Country code
	None
U	Imperial connection

Data sheet

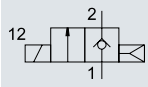
Function



-  Voltage
24 V DC
-  Pressure
+0.5 ... +6 bar
-  Temperature range
-5 ... +60°C

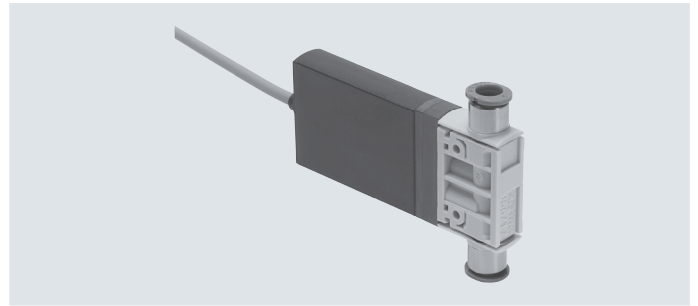

General technical data

Type	MF	HF/LP	HF
Valve function	2/2-way valve, single solenoid, closed		
Design	Poppet valve without mechanical spring return		
Sealing principle	Hard		
Note on operation	Do not operate without flow		
Actuation type	Electrical		
Reset method	Pneumatic spring		
Type of control	Direct		
Flow direction	Non-reversible		
Mounting position	Any		
Width [mm]	10 ¹⁾		
Grid dimension [mm]	10.5		
Standard nominal flow rate [l/min]	100	160	160
C value [l/sbar]	0.4	0.66	0.66
b value	0.38	0.36	0.36
Type of mounting	In-line installation or via through-holes		
Pneumatic connection 1 and 2	QS-1/4		

1) Min. permitted grid dimension 10.5 mm

Operating and environmental conditions

Type	MF	HF/LP	HF
Operating medium	Compressed air to ISO 8573-1:2010 [7:4:4]		
Note on the operating/pilot medium	Lubricated operation not possible		
Operating pressure [MPa]	+0.05 ... +0.6	+0.05 ... +0.4	+0.05 ... +0.6
[bar]	+0.5 ... +6	+0.5 ... +4	+0.5 ... +6
Ambient temperature [°C]	-5 ... +60		
With block mounting [°C]	Max. +45	Max. +45	-
Temperature of medium [°C]	-5 ... +60		
Restricted ambient temperature and temperature of medium	As a function of switching frequency (see graph)		
Storage temperature [°C]	-20 ... +50		
Permissible solenoid surface temperature [°C]	+120		
Corrosion resistance class CRC ¹⁾	2		
CE marking (see declaration of conformity)	To EU EMC Directive ²⁾		
KC mark	KC EMC		
Certification	RCM		
PWIS conformity	VDMA24364-B2-L		
Note on materials	RoHS-compliant		

1) Corrosion resistance class CRC 2 to Festo standard FN 940070

Moderate corrosion stress. Indoor applications in which condensation can occur. External visible parts with primarily decorative surface requirements which are in direct contact with a normal industrial environment.

2) For information about the area of use, see the EC declaration of conformity at: www.festo.com/catalogue/... → Support/Downloads.

If the devices are subject to usage restrictions in residential, commercial or light-industrial environments, further measures for the reduction of the emitted interference may be necessary.

Data sheet

Electrical data			MF	HF/LP	HF
Type					
Operating voltage ¹⁾	[V DC]		24 ±10% = 21.6 ... 26.4		
Trigger signal range	[V DC]		3 ... 30		
Input resistance	[kΩ]		34		
Note on input current			Linear rise		
			0.09 ... 0.44 mA with a trigger signal of 3 ... 15 V DC		
			0.44 ... 15.44 mA with a trigger signal of 15 ... 30 V DC		
Power	Low-current phase	[W]	2	2	3.2
	High-current phase	[W]	7	7	14.5
Reverse polarity protection			For operating voltage		
Additional functions			Spark arresting		
			Holding current reduction with energy recovery		
			Safety shut-off		
Degree of protection to EN 60529		IP55			
Duty cycle ²⁾	[%]		100	100	–
Operating conditions to DIN VDE 0580 ²⁾	With individual valve		–	–	S3 50% 20 min.
	With block mounting		–	–	S3 25% 20 min.
Electrical connection			Cable, 3-wire		

1) If there is a current limit during the switching operation, it must be set to at least 1.7 A.

2) Air must flow through the valve continuously

Switching times and frequencies			MF	HF/LP	HF
Type					
Maximum switching frequency			1000	500	500
Tolerance for switching time	On		±15		
	Off		+15/–25		
Switching times for 24 V DC when new					
Pressure 0.05 MPa (0.5 bar, 7.25 psi)	Switching time on		0.8	0.8	1
	Switching time off		0.5	0.6	0.8
Pressure 0.4 MPa (4 bar, 58 psi)	Switching time on		0.8	1	1.2
	Switching time off		0.4	0.5	0.6
Pressure 0.6 MPa (6 bar, 87 psi)	Switching time on		0.9	–	1.3
	Switching time off		0.4	–	0.6

 **Note**

The maximum switching frequency that can be achieved decreases as the temperature of the valve increases or as the operating and ambient temperature increases. The ambient temperature must therefore be limited accordingly so that the maximum switching frequency can be reached.

Data sheet

Switching behaviour – Operating pressure

Type MF and HF/LP

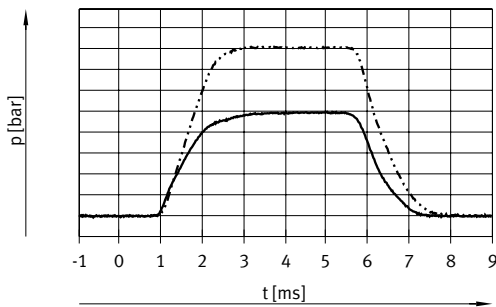

— 4 bar
- - - - - 6 bar

Type HF

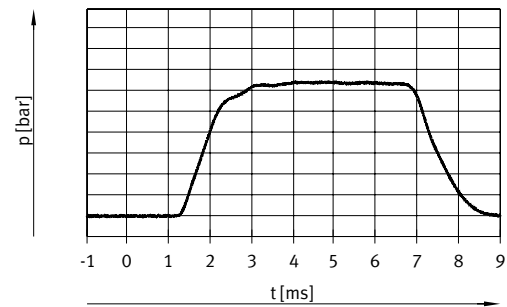

— 4 bar

Switching behaviour – Current/voltage curve

Type MF and HF/LP

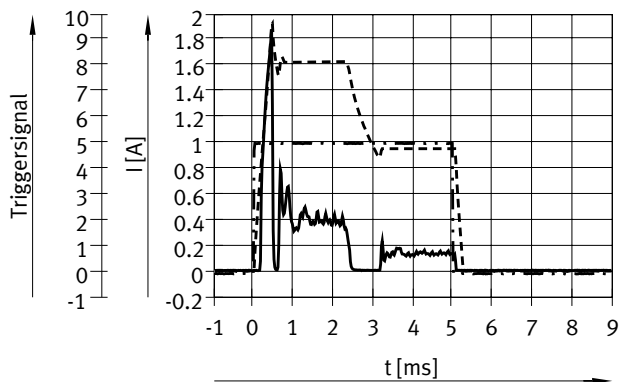

— Current in the supply line at 24 V
- - - - - Trigger signal
- · - · - Coil current

Type HF

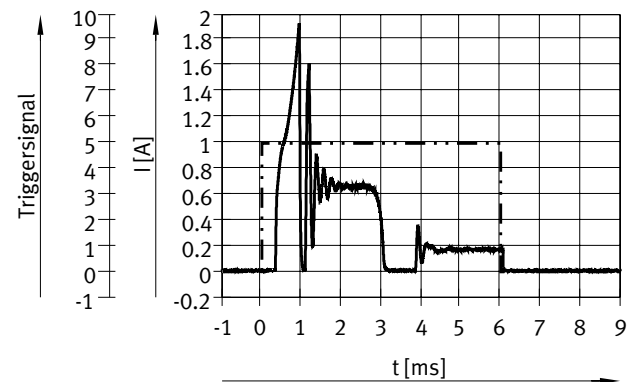

— Current in the supply line at 24 V
- - - - - Trigger signal

Materials

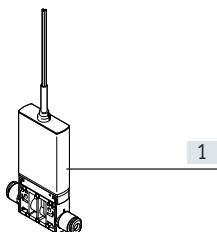

[1]	Housing	Reinforced PA Reinforced PPS
-	Seals	HNBR
-	Screws	Steel
-	Cable sheath	PUR
-	Manifold rail	Anodised wrought aluminium alloy

Data sheet

Dimensions

Download CAD data → www.festo.com

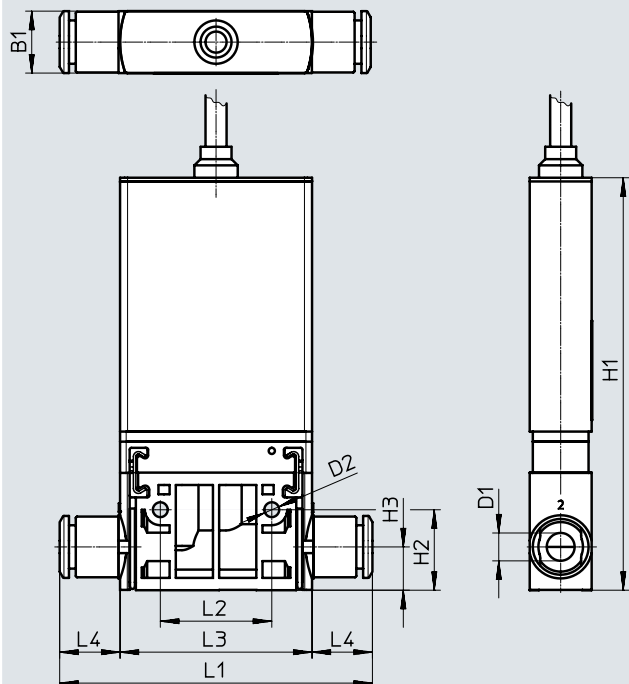

Wire allocation:
 BU = GND
 BN = Operating voltage positive
 BK = Trigger signal

Type	B1	D1	D2	H1	H2	H3	L1	L2	L3	L4
MHJ10	10	1/4"	2.4	68	13	7	50.5	18	32	9.5

Ordering data

	Description	Standard nominal flow rate	Cable length	Product weight	Operating pressure	Part no.	Type
	2/2-way solenoid valve	100 l/min	0.35 m	50 g	+0.05 ... +0.6 MPa	562172	MHJ10-S-0.35-QS-1/4-MF-U
			2.5 m	85 g	+0.05 ... +0.6 MPa	565517	MHJ10-S-2.5-QS-1/4-MF-U
		160 l/min	2.5 m	85 g	+0.05 ... +0.4 MPa	567800	MHJ10-S-2.5-QS-1/4-HF/LP-U
					+0.05 ... +0.6 MPa	567504	MHJ10-S-2.5-QS-1/4-HF-U

Festo - Your Partner in Automation



1 Festo Inc.
5300 Explorer Drive
Mississauga, ON L4W 5G4
Canada

Festo Customer Interaction Center
Tel: 1 877 463 3786
Fax: 1 877 393 3786
Email: customer.service.ca@festo.com



2 Festo Pneumatic
Av. Ceylán 3,
Col. Tequesquináhuac
54020 Tlalnepantla,
Estado de México

Multinational Contact Center
01 800 337 8669
ventas.mexico@festo.com



3 Festo Corporation
1377 Motor Parkway
Suite 310
Islandia, NY 11749

Festo Customer Interaction Center
1 800 993 3786
1 800 963 3786
customer.service.us@festo.com



4 Regional Service Center
7777 Columbia Road
Mason, OH 45040

Connect with us



www.festo.com/socialmedia



www.festo.com

Subject to change