

PACSystems™ IC695CPE400 64MB Rackless CPU

GFK-3002G

May 2021



Contents

Contents	i
Front Panel Description	1
User Features	2
Switches	6
Displays and Indicators (LEDs)	7
OLED Display	7
Front-Panel Ethernet Ports	11
Serial COM Port	12
Video Display Port	12
Field Agent Port	12
Energy Pack Connector	13
Input Power Connector	13
Removable Data Storage Device (RDSD)	13
Hardware Installation	14
Initial Checks	14
Installation	14
Installation in Hazardous Areas	18
Connect to Power Supply	18
Module Start-up	21
Basic Start-up Steps	22
Configuration	23
Start the Embedded Field Agent (EFA)	24
Log into the Web Console	25
Redundancy Configuration	32
Additional Information	34
General Contact Information	35

Front Panel Description

Figure 1: Display, Lights, and Connectors on the CPE400

OLED Display

- LAN Settings
- Control Status
- I/O Status
- Device Info
- Linux Settings
- Redundancy (RDN) Info
- Redundancy (RDN) Commands

TPM Physical Presence Indication/Select (Phy Pres)

(Green = Present)

Solid State Disk Activity (SSD)

(Green = Activity)

Overtemperature (TEMP)

(Amber = Overtemperature)

Active Redundant Unit (RACT)

(Green = Active)

Redundant Backup Unit OK (RBOK)

(Green = OK)

General Purpose OK (GPOK)

(Blinking Green = Linux Running)

Underside Ports and Connectors

Micro-SD Card Slot (Side) & Protective Cover

Display Menu Navigation (DISP)

Display Menu Selection (SEL)

Run Mode Selection

PLC Mode Indication

(Green = Run)

STOP Mode Selection

CPU OK (OK)

(Green = OK)

Outputs Enabled (OE)

(Green = OK)

Force Applied (FRC)

(Yellow = Enabled)

System Fault Present (FLT)

(Red = Fault Present)

I/O Network Status (IO)

(Green = OK)

Power/Reset (PWR)

(Green = Power On)
Button - Hold for Reset

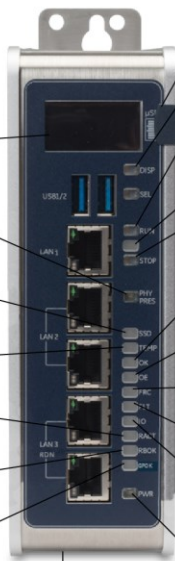

User Features

The PACSystems™ RX3i CPE400, part of Emerson's Industrial Internet Control System, is the industry's first outcome optimizing controller. It augments real-time deterministic control with Field Agent technology, delivering near real time advice through market analysis, fleet and enterprise data, or asset/process knowledge to optimize the outcomes that today's businesses require. The Predix™ enabled CPE400 provides reliable, secure communication and analytics using either cloud-based or edge-based outcome optimizing apps. Controls can now be programmed to dynamically influence business outcomes, generate new forms of revenue, and improve profitability.

- The stand-alone CPE400 uses a quad-core microprocessor and real-time hypervisor technology to run real time deterministic control applications concurrently with Field Agent technology without any adverse impact of one over the other.
 - A built-in RX3i PLC:
 - User may program in Ladder Diagram, Structured Text, Function Block Diagram, or C.
 - Contains 64Mbytes of configurable data and program memory.
 - Supports auto-located Symbolic Variables that can use any amount of user memory.
 - Reference table sizes include 32k bits for discrete %I and %Q and up to 32k words each for analog %AI and %AQ. Bulk memory (%W) also supported for data exchanges.
 - Supports up to 768 program blocks. Maximum size for a block is 128KB.
- Field Agent technology is a platform for securely applying Predix applications and secure connectivity to the Predix Cloud as well as running

edge apps. Running the Field Agent concurrently with the real-time control applications allows the CPE400 to rapidly leverage external data. External monitoring may be used to analyze and optimize entire business operations. The analysis can then be used to dynamically adjust real-time industrial controls to align with changing business objectives in today's Industrial Internet age.

- Supports four independent 10/100/1000 Ethernet LANs. Three are located on the front panel, as shown in Figure 1. LAN1 attaches via the upper, dedicated RJ 45 connector. LAN2 and LAN3 each attach via a pair of internally-switched RJ 45 connectors. The fourth LAN, labeled EFA (Embedded Field Agent), is located on the underside and is specifically used for Field Agent connectivity (see Field Agent bullet just above).
- The embedded communications interface has dedicated processing capability, which permits the CPU to independently support LAN1 and LAN2 with:
 - up to 48 simultaneous SRTP Server connections;
 - up to 16 simultaneous Modbus/TCP Server connections;
 - 32 Clients are permitted; each may be SRTP or Modbus/TCP.
 - OPC UA Server with support for up to 5 concurrent sessions with up to 10 concurrent variable subscriptions and up to 12,500 variables;
 - up to 255 simultaneous Class 1 Ethernet Global Data (EGD) exchanges.
 - DNP3 Outstation support with up to 8 master client connections
- The embedded PLC may use one or both of the Ethernet LAN2 ports to support the embedded Simplex PROFINET I/O Controller. PROFINET supports up to 32 I/O devices in simplex configuration or 20 I/O devices in Hot Standby Redundancy configuration, both supporting update rates of 1 – 512 ms.. I/O device update rates of 8 ms and faster are possible with 16 or fewer devices. Update rates of 16 ms and higher result whenever more than 16 devices are configured.

- Media Redundancy Protocol (MRP) allows the CPE400 to participate in a PROFINET I/O network with MRP ring technology. This eliminates the I/O network as a single point of failure. The CPE400 may be used as either a Media Redundancy Manager or Media Redundancy Client.
- Effective with firmware release 9.30, the CPE400 supports Hot Standby Redundancy with PROFINET IO. In this configuration, LAN3 is used as a high-speed data synchronization link between the two redundant CPUs. Only the Primary and Secondary CPUs may be attached to LAN3. Two OLED menu items support Redundancy operation: RDN Info and RDN Command. The RACT and RBOK LEDs reflect the status of the Redundant CPUs.
- Effective with firmware release 9.30, the CPE400 supports two independent Redundant IP addresses, one for LAN1 and one for LAN2. LAN2 Redundant IP is supported when configured for Ethernet mode only. Redundant IP is supported by the SRTP Server, Modbus TCP Server, and EGD protocols. It is not possible to use Redundant IP with the OPC UA Server or with the Ethernet firmware update web page.
- The CPE400 is secure by design, incorporating technologies such as Trusted Platform Modules, secure boot, and encrypted firmware updates.
- Optional Energy Pack, IC695ACC403, allows CPE400 to instantly save user memory to non-volatile storage in the event of loss of power.
- OPC UA Sweep Mode & Sweep Time: The CPE400's sweep mode and sweep time are available through the OPC UA server. The Sweep Mode variable reports the controller's current mode: Stop Disabled, Run Enabled, Stop Enabled, Run Disabled, Stop Faulted, and Stop Halted. The Sweep Time variable reports the sweep time in seconds. These variables are located under Device Information -> PACSystems RX3i -> Controller.
- An OLED display that provides access to basic CPE400 status and control information including each LAN's configured IP Address.
- Operating temperature range -40 °C to 70 °C (-40 °F to 158 °F).
- Alternate panel-mount adaptor plate included.

- Effective with firmware release 10.15, the CPE400 supports Sequence of Events recording through the Embedded PROFINET Controller when used with up to five IC695PNS101 *Advanced PROFINET Scanner* modules and a pair of dedicated C program blocks designed to configure and collect SoE records and provide diagnostics. An RX3i SoE system supports events from up to 640 SoE input points with a system storage buffer for up to 128,000 events at a maximum rate of 400 events per second per PNS101. Each PNS101 supports SoE recording with IRIG-B time synchronization of events accurate to 1ms and buffers up to 4000 events from up to four IC694MDL660 *24Vdc 32-Point Grouped Discrete Input* or IC694MDL655 *24Vdc 32-Point Positive/Negative Logic Input* modules. Unmodulated IRIG-B time signals are decoded by the PNS101 using either an IC695HSC304 or IC695HSC308 *High Speed Counter Module*. SoE recording is available in both simplex and redundant PROFINET systems.
- Effective with firmware release 10.10, the CPE400 supports OPC UA Non-Transparent Server Redundancy.

Switches

All user-accessible switches are provided as pushbuttons on the front panel as described below.

Pushbutton	Function
DISP	Permits user to navigate menus in the OLED display.
SEL	Permits user to select the menu item on the OLED display.
RUN	Activates OLED Menu to select RUN/Enabled or RUN/Disabled Mode for the embedded PLC.
STOP	Activates OLED Menu to select STOP/Enabled or STOP/Disabled Mode for the embedded PLC.
PHY PRES	Not functional.
PWR	Hold down for brief period to induce CPU Reset. Note that this does not turn unit power off, but only holds unit in Reset

Displays and Indicators (LEDs)















OLED Display

The monochrome organic light-emitting diode (OLED) display is used to display CPE400 system menus. It interacts with the DISP pushbutton, which jogs the cursor from one menu item to the next, and with the SEL pushbutton, which activates the currently indicated menu item for further action.



















The OLED display permits the user to:

- Display Ethernet LAN Settings: IPv4 address.
- Display the PLC firmware revision.
- Set/view PLC mode and view sweep time.
- Set the PLC mode to RUN/STOP with I/O Enabled/Disabled via the display. Note: the RUN and STOP pushbuttons activate the PLC Mode menu items per section *Switches*.
- View whether all, some, or none of the PROFINET I/O devices are connected.
- Display EFA Settings: IPv4 address, subnet mask, gateway, MAC address, IPv6 address.
- Issue Field Agent Commands: Enter/Exit Configuration mode, Clear Configuration, Perform factory reset.
- View Field Agent Status: Off, Starting, Connecting, Connected, Connected-ACT.
- View HSB Redundancy Mode and State (Release 9.30 and later)
- Command an HSB Redundancy Role Switch (Release 9.30 and later)





Status Indicators (LEDs)

LED	LED State	Operating State
PLC MODE 1	 On Green	PLC is in RUN mode.
	 Off	PLC is in STOP mode.
RUN OE	 Blinking  in unison	CPU is updating an internal programmable hardware device.
PHY PRES	 On Green	TPM Physical Presence (not functional).
	 Off	
SSD	 On Green	Activity detected on Solid State Disk.
	 Off	No activity detected on Solid State Disk.
TEMP	 On Red	CPU Overtemperature condition detected.
	 Off	Overtemperature condition not detected.
OK	 On Green	CPU has passed its power-up diagnostics and is functioning properly. (<i>Following initialization sequence.</i>)
	 Off	Power is not applied or CPU has a problem.
	 Blinking; All other LEDs off	PLC in STOP/Halt state; possible watchdog timer fault. If the programmer cannot connect, cycle power with charged Energy Pack attached and refer to fault tables.
OK OE	 Blinking  alternatel	CPU encountered a Secure Boot Error.







¹ This LED is located between the RUN and STOP pushbuttons. It indicates the PLC Mode.

LED	LED State	Operating State
OE	 On Green	Output scan is enabled.
	 Off	Output scan is disabled.
FRC	 On Yellow	One or more Overrides active in I/O Reference Table(s).
	 Off	No Overrides active in any I/O Reference Table.
FLT	 On Red	PLC is in STOP/Faulted mode: a fatal fault has occurred.
	 Off	No fatal faults detected.
IO	 On Green	PROFINET Connection Status = OK.
	 Off	PROFINET Connection Status not OK.
RACT	 On Green	Local Redundant CPU is Ready & Active.
	 Off	Local Redundant CPU is not Ready.
RBOK	 On Green	Remote Redundant CPU is Ready.
	 Off	Remote Redundant CPU is not Ready.
FAOK	 On Green	Field Agent Running and Connected to Cloud.
	 Blinking Green	Blink at 0.5 Hz: Field Agent Starting. Blink at 1 Hz: Field Agent Running.
	 Off	Field Agent Off.
PWR	 On Green	CPU running.
	 Blinking Green	Booting up – diagnostics in progress.
	 On Red	Off
	 Off	Reset / Power not detected.

Front Ethernet Indicators (LAN1, LAN2, LAN3 RJ45 Built-in LEDs)

LED	LED State	Operating State
Link Status (upper)	 On Green	The corresponding link has been established.
	 Blinking Green	Traffic is detected at the corresponding port.
	 Off	No connection established at corresponding port.
Link Speed (lower)	 On Green	Corresponding data speed is 1 Gbps or 100 Mbps.
	 Off	Corresponding network data speed is 10 Mbps

Bottom Ethernet Indicators (EFA RJ45 Built-in LED)

LED	LED State	Operating State
Link Status (upper)	 On Green	The corresponding link has been established.
	 Blinking Green	Traffic is detected at the corresponding port.
	 Off	No connection established at corresponding port.
Link Speed (lower)	 On Green	Corresponding network data speed is 1 Gbps.
	 On Yellow	EFA port only: network data speed is 100 Mbps
	 Off	Corresponding network data speed is 10 Mbps

Front-Panel Ethernet Ports

LAN1 connects to the uppermost RJ45 connector. It is not switched.

LAN2 connects to the middle two RJ45 connectors. These two ports are switched internally.

LAN3 connects to the two lower RJ45 connectors. These two ports are switched internally. LAN3 may only be used to supply a high-speed synchronization link between the Primary and Secondary CPUs in Hot Standby Redundancy. Both ports are typically used, as described in the *PACSystems Hot Standby CPU Redundancy User Manual*, GFK-2308 (revision L or later).

Each of the embedded Ethernet interfaces automatically senses the data rate (10 Mbps or 100 Mbps or 1 Gbps), communications mode (half-duplex or full-duplex), and cabling arrangement (straight-through or crossover) of the attached link. LEDs embedded in each RJ45 connector provide indications per the table above.

LAN1 or LAN2 may be used to communicate with the PME programming software using the Service Request Transport Protocol (SRTP).

To establish Ethernet communications between the PME programming and configuration software and the CPU, you *first* need to know the target IP address. Use the OLED menu function to check the IP Address. The factory-shipped default settings are:

	CPE400 LAN1	CPE400 LAN2	CPE400 LAN3
IP Address:	192.168.0.100	10.10.0.100	N/A
Subnet	255.255.255.0	255.255.255.0	N/A
Mask:			
Gateway:	0.0.0.0	0.0.0.0	N/A

Serial COM Port

The RJ45 port marked Serial COM is located on the underside of the CPE400, as shown in Figure 2. Effective with firmware release 9.40, the CPE400 supports the serial port. This port supports Serial IO protocol.

Video Display Port

The Display Port is located on the underside of the CPE400, as shown in Figure 2. It provides signals for connecting either a suitable monitor or video adapter to the unit. **This port is not currently supported.**

Field Agent Port

The RJ45 port marked EFA is located on the underside of the CPE400, as shown in Figure 2. This is an Ethernet port pre-configured to connect securely to the Predix cloud environment. For additional information concerning use of this port, refer to the *PACSystems RX3i and RSTi-EP CPU*

Figure 2: Underside Ports & Connections

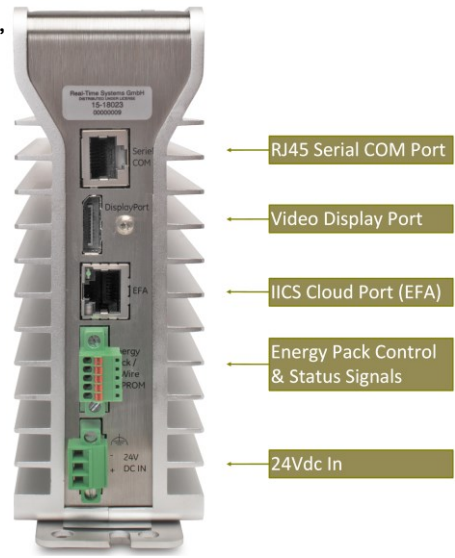

Reference Manual, GFK-2222 or later. For more detailed information regarding Field Agent, refer to the *Field Agent User's Guide*, GFK-2993.

The FAOK LED, located on the front panel, indicates the status of the Field Agent interface.

Energy Pack Connector

The CPE400 compatible Energy Pack, IC695ACC403, is supplied with a purpose-built cable, IC695CBL003, which installs in the 24 VDC In and Energy Pack Control & Status connectors shown in Figure 2. Use of the Energy Pack is optional. When used, it allows the CPE400 to save its current state upon loss of power. Refer to the *PACSystems RX3i Rackless Energy Pack IC695ACC403 Quick Start Guide*, GFK-3000, for complete wiring and grounding instructions.

Input Power Connector

If no Energy Pack is to be connected, refer to the section entitled *Connect to Power Supply*. Otherwise, refer to the *PACSystems RX3i Rackless Energy Pack IC695ACC403 Quick Start Guide*, GFK-3000.

Removable Data Storage Device (RDSD)

The CPE400 is equipped with a micro-SD card slot and two USB ports. **These are not currently supported.**

Hardware Installation

Initial Checks

Upon receiving your equipment, carefully inspect all shipping containers for damage. If any part of the system is damaged, notify the carrier immediately. The damaged shipping container should be saved as evidence for inspection by the carrier.

As the consignee, it is your responsibility to register a claim with the carrier for damage incurred during shipment. Emerson will fully cooperate with you, however, should such action be necessary.

After unpacking the equipment, record all serial numbers. Serial numbers are required if you should need to contact Customer Care during the warranty period. All shipping containers and all packing material should be saved should it be necessary to transport or ship any part of the system.

Verify that all components of the system have been received and that they agree with your order. If the system received does not agree with your order, contact Customer Care.

Installation

As shipped, the CPE400 is intended for mounting on a DIN rail. A panel-mount adaptor is also available. If panel-mounting is required, replace the DIN-rail adaptor with the panel-mount adaptor using the screws supplied with that adaptor. Both adaptors attach to the rear of the CPE400 chassis using four Torx M3 screws. Torque newly-installed screws to 5.3 in-lbs (0.6 Nm) if installing a new adaptor plate.

For installation to standards, refer to the *Installation and Maintenance Requirements* document, GFK-3004.

Note the thermal requirements for mounting the equipment (Figure 3).

Mount on the DIN rail per Figure 4.

1. Incline the unit so that the upper hooks of the DIN rail adaptor engage with the upper edge of the DIN rail.
2. Press on the lower part of the unit until you hear a click. The click indicates that the lower hooks of the DIN rail adaptor have engaged with the lower edge of the DIN rail.

Dismount from the DIN rail per (Figure 4).

1. Grasp the unit securely.
2. Press down on the release bar as indicated.
3. Swivel the unit away from the DIN rail, then remove.

Figure 3: Thermal Spacing Requirements

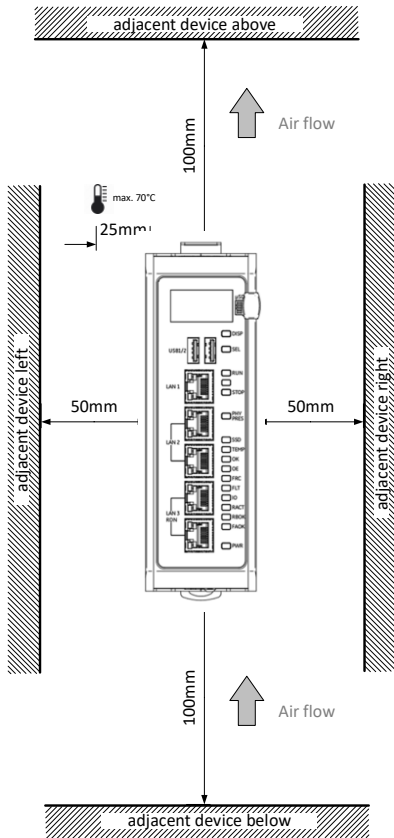

Figure 4: Mounting on DIN Rail

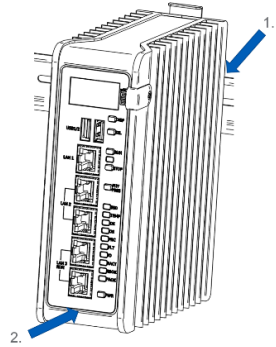
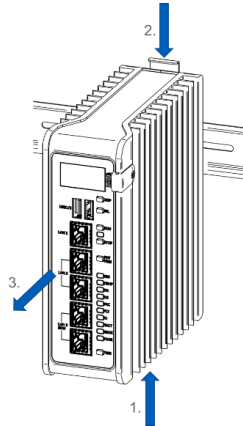

Figure 5: Dismounting from DIN Rail



If using the panel-mount adaptor, two options are available: mount using two screws (Figure 6) or, for more secure mounting, mount using four screws (Figure 7).

Figure 6: Two-Screw Panel Mount

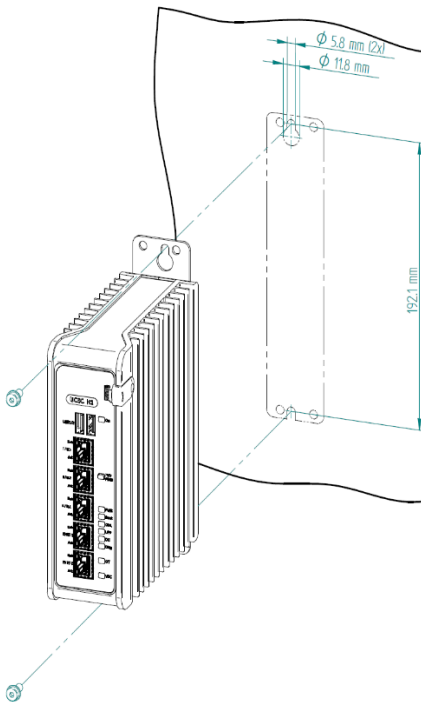
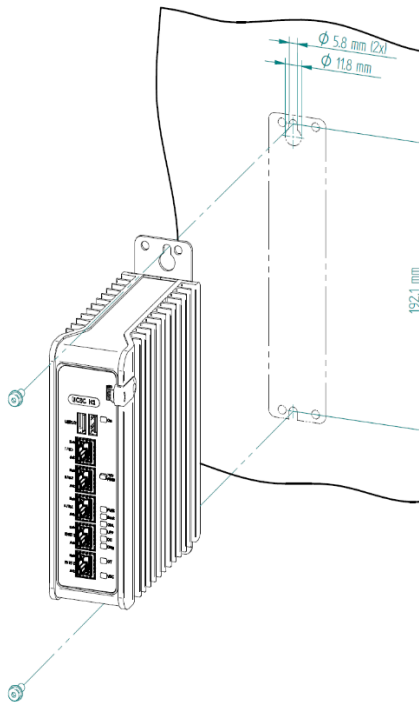

Figure 7: Four-Screw Panel Mount



Installation in Hazardous Areas

Refer to the Installation and Maintenance Requirements document, GFK-3004.

Connect to Power Supply

The 24Vdc power input connector is located on the underside of the CPE400, as shown in Figure 8. The signal pinouts are also indicated.

The mating connector for the CPE400 24Vdc power input is the 3-pin Phoenix 1827716 shown in Figure 9. The power supply cable prepared by the user must use the specified mating connector.

The positive “+” and negative “-” signals are required. FGND is optional but recommended.

For the mating connector, the compatible conductor size is from 24AWG to 16AWG. Strip the wires back 7mm before inserting into the connector. Tightening torque for the three signal screws is 2.2 in-lbs (0.248Nm). Secure the mating connector to the power input connector via the two captive screws provided.

Figure 8: 24 VDC Power Input Connector



The user-supplied SELV² power supply must supply voltage in the range of 18Vdc to 30Vdc.

Once the power supply cable (or compatible Energy Pack ACC403) has been attached to the CPE400 and the power supply has been turned on, the unit will start booting. There is no need to push any button.

The unit is equipped with built-in reverse polarity protection. If + and - are swapped the unit will not power-up. If + is connected to FGND, this will cause a short. The power supply needs to protect itself against this condition.

Figure 9: 24 VDC Power Input Module Connector

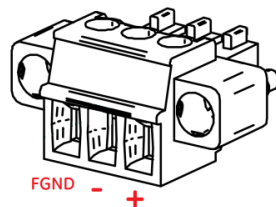

Inrush Current

The CPE400 may experience an inrush current of up to 49 A for 15 μ s.

Overvoltage protection

In the CPE400, the voltage to the inner loads is clamped to 33 VDC. At 33 VDC, the internal clamping diode starts conducting at 1 mA. Any further increase in the voltage will cause the internal current fuse to blow and/or the clamping diode to break.

² SELV = Safety Extra Low Voltage

CAUTION

EQUIPMENT REPAIR REQUIRED – Internal components must be repaired at the factory; they are not field replaceable. Contact the support team at the link provided at the end of this document.

Overcurrent protection

The function protects the internal circuitry from overcurrent conditions before serious damage can occur, such as overheating of the equipment. The fuse is rated for 4A continuous current. Once the sensed current reaches 40A, the fuse will blow after a period of 10ms to 100ms.

CAUTION

EQUIPMENT REPAIR REQUIRED – Internal components must be repaired at the factory; they are not field replaceable. Contact the support team at the link provided at the end of this document.

Grounding

Grounding via the FGND connection on the 3-pin 24Vdc In power header is recommended (see section *Connect to Power Supply*), but is not required if the CPE400 is mounted to a grounded metal panel. Furthermore, if an Energy Pack is connected, be sure to comply with grounding procedures as described in *PACSystems RX3i Rackless Energy Pack IC695ACC403 Quick Start Guide*, GFK-3000.

Module Start-up

You Will Need:

- This PACSystems Rackless RX3i CPU.
- A compatible SELV 24Vdc, 48W power supply (72W if Energy Pack attached).
- (Optionally) A compatible Energy Pack, IC695ACC403, and corresponding cable.
- If no Energy Pack is to be attached, use the power supply cable described in section *Connect to Power Supply*.
- A DIN rail, typically mounted in an enclosure, as discussed above. Alternately, mount the unit using the compatible panel-mount adaptor.
- A computer running PAC Machine Edition™ (PME) configuration and programming software. PME Version 9.70 SIM 16 or later supports the CPE400. Version 9.50 SIM 5 is required for Hot Standby Redundancy.
- Ethernet cable for connecting the PME programmer computer to the CPE400.
- Additional cables, as needed, to connect each port employed in the application.
- A very small slotted screwdriver to secure the 24 Vdc mating connector.
- A T8 Torx screwdriver, if the micro-SD slot cover is to be removed. Note that the cover must be replaced to achieve immunity from electrical noise.
- A T10 Torx screwdriver, if exchanging the mounting adaptors.

Basic Start-up Steps

For startup and configuration of the CPE400, complete the following steps. For full details on CPE400 operation, refer to the *PACSystems RX3i and CPU Reference Manual*, GFK-2222.

1. Mount the CPE400, as described in section *Installation* and per the *Installation and Maintenance Requirements* document, GFK-3004.
2. Attach the user-supplied power supply cable as described in if no Energy Pack is being used.
3. (optionally) Mount and attach the compatible Energy Pack, IC695ACC403, as described in the *PACSystems RX3i Rackless Energy Pack IC695ACC403 Quick Start Guide*, GFK-3000.
4. Turn on the power supply unit: the unit should then run without the need to press any buttons.
5. If not previously configured, configure the RX3i PLC using PME 9.00 SIM 8 or later, as described in the *Configuration* section below.

Note: When the ACC403 Energy Pack is powered up, a finite period is required to charge it up to its operating level. During this time, the Energy Pack will indicate this condition via its LEDs (refer to the *PACSystems RX3i Rackless Energy Pack IC695ACC403 Quick Start Guide*, GFK-3000).

The CPE400 will begin its boot cycle immediately upon power application. However, the embedded controller will not start its control until the ACC403 is charged. This typically takes 45 seconds or less. In the event the ACC403 is faulty or is not communicating, CPE400 commences operation without the Energy Pack.

Note: In the event of loss of power with the ACC403 Energy Pack connected and charged up, the CPE400 remains on for 4 seconds to backup user memory into its non-volatile memory.

Configuration

To configure, the CPE400, connect the computer running the PME programming software to any of the front-panel Ethernet ports. PME 9.00 SIM 8 or later is required

The CPE400 is the first controller available in the *PACSystems RX3i Rackless* family. Configuration will either start out using the RX3i Rackless CPE400 template when creating a new project, or will convert an existing project to the CPE400 using the *Family Conversion* feature in PME.

Backwards Compatibility

To convert an existing project which uses any other PLC, use the *Family Conversion* feature in PME. Be aware of the constraints involved, as will be notified in PME. For instance, the first PROFINET® Controller in an RX3i CPU320 application will be assigned to the embedded PROFINET Controller feature of the CPE400.

PROFINET Controller Configuration

An Embedded PROFINET Controller may be configured on LAN2. To enable the PROFINET Controller in a CPE400 project, select the CPE400 target in the *PME Navigator* (Figure 10) and open the Hardware Configuration. On the *Settings* tab, change the designated *LAN Mode* of the selected port to *PROFINET*. The *PROFINET Controller* node description then displays that a PROFINET node exists on the selected LAN (under the CPE400). For further

details, refer to the *PACSystems RX3i PROFINET IO Controller User Manual*, GFK-2571.

Figure 10: PME Navigator Showing PROFINET Node on LAN2

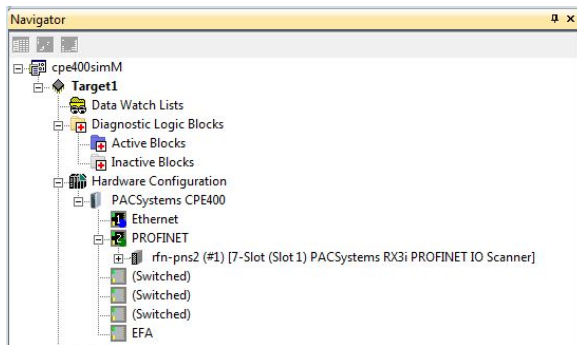

Start the Embedded Field Agent (EFA)

After providing the CPE400 with power, the Embedded Field Agent (EFA) application will begin to boot. The FAOK LED will start blinking to indicate when the EFA has booted and is ready for user logins. (This may take about two minutes.)

Log into the Web Console

1. Connect a computer to the EFA's IICS Cloud Port or EFA Port.
2. Configure the computer's network adapter to be an address on the Field Agent network.
 - The EFA's default IICS Cloud Port or EFA Port is assigned 172.31.0.100 with subnet mask 255.255.0.0. Set your computer's network adapter to any other IP address on the 172.31.x.x network. For example, 172.31.0.101 with subnet mask 255.255.0.0.
3. Use the OLED Menu to enable Configuration Mode as follows:
 - a. From the Main Menu, select the "FA Settings" menu item.
 - b. From the FA Settings Menus, select the "Commands" menu item.
 - c. From the Commands Menus, select the "Config Mode" menu item.
 - d. Confirm entering Config Mode.
 - e. Configuration Mode will remain active for one hour or until the above steps are repeated to disable Configuration Mode.

Note: Browsing to the Web Console too soon may result in seeing an Authentication Required or similar drop-down/pop-up dialog. Entering a user name and password into this dialog will not permit a log-in to the Web Console. Wait for the Field Agent to fully boot as indicated by the FAOK LED and re-attempt to browse to the Web Console. Closing the current browser tab or window may also be required.

4. Using Google Chrome (recommended), browse to the Field Agent's Web Console at <https://172.31.0.100:8443/system/console>.
5. Since the Web Console uses a self-signed certificate, the browser will warn that the connection is not private. When prompted, accept the connection.
6. Login using the default credentials.
 - Default User Name: **predix**
 - Default Password: **predix2machine**

Figure 11: Web Console Login Screen

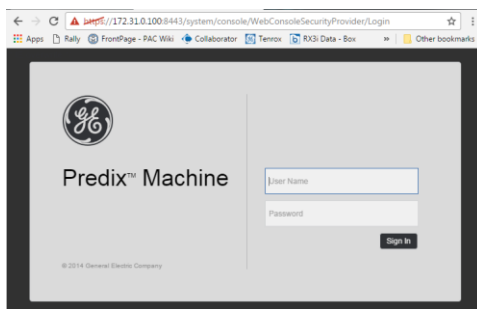

7. A prompt to change the default password displays. Complete the form to change the default password.
8. The password complexity requirements display if the chosen password is not sufficiently complex. After changing the password, log in using the new password.
9. Verify that the *Log Service* page displays, which indicates a successful login.

Figure 12: Log Service Page

Received	Level	Message	Service	Bundle	Exception
7/6/2016, 12:47:12 PM	INFO	User "predix" successfully logged in.		Predix Machine Management (Impl)	
7/6/2016, 12:47:06 PM	INFO	Password has been created/changed for user "predix"		Predix Machine Management (Impl)	
7/6/2016, 12:47:05 PM	INFO	User "predix" successfully logged in.		Predix Machine Management (Impl)	

Note: After some idle time, the Web Console will time out. If this occurs, the user will need to return to the main page to log back into the console. Session timeout does not automatically redirect the console back to the login page.

Configure the Network

EFA IP Addresses

By default, the Embedded Field Agent's WAN interface is set to a static address of 172.31.0.100 with a subnet mask of 255.255.0.0.

To change the WAN IP address

1. Verify that the WAN Ethernet cable is connected to the IICS Cloud port / EFA Port. If a network proxy is needed to connect the field agent to the WAN, refer to the section *Configure a Network Proxy*.

From the Web Console, navigate to the *Technician Console, Network Configuration* page.

Figure 13: Technician Console, Network Configuration Page

The screenshot displays the 'Network Settings' configuration page. It is divided into three main sections:

- WAN:** This section is currently selected. It offers two options for IP address assignment: 'Obtain an IP address automatically' (unselected) and 'Use the following IP address' (selected). Under the selected option, there are input fields for 'IP Address' (172.31.0.100), 'Subnet Mask' (255.255.0.0), and 'Gateway'. Below these, there are two options for DNS server addresses: 'Obtain DNS server address automatically' (unselected) and 'Use the following DNS server addresses' (selected). This section includes input fields for 'Primary DNS' and 'Secondary DNS', and a 'Query Current Status' button.
- Proxy Settings:** This section contains a checkbox labeled 'Enable HTTP/HTTPS proxy', which is checked. Below it is a 'Proxy host & port:' input field with the example text 'ie. my-proxy.com:8080 or 192.168.2.25'.
- Cloud Connection:** This section has the instruction 'Use the following interface to connect to the cloud:'. It features two radio button options: 'Ethernet WAN' (selected) and 'Cellular Modem'.

At the bottom of the page, there is a 'Save Changes' button.

2. DHCP can be used for networks where a DHCP server is available, and a static IP address for networks where each device is manually assigned an address. Click the Save button to accept the changes.

Note: The DNS servers can also be configured to be obtained automatically or specified statically. When using a static IP address, DNS servers must also be specified statically.

Configure a Network Proxy

A Network Proxy is only required when your network architecture is configured to restrict access directly to the Internet. Contact your network administrator for the Network Proxy information.

If a network HTTP/HTTPS proxy server is used to route traffic from the intranet to the Internet, the network proxy must be configured in the Web Console under *Technician Console, Network Configuration*. To add or update a network proxy server, check the “Enable HTTP/HTTPS Proxy” check box, enter the proxy server’s address and port in the form “proxy:port” into the Proxy Settings text box, and press the Save button.

Figure 14: Proxy Settings

Proxy Settings

Enable HTTP/HTTPS proxy

Proxy host & port: my-proxy.com:80

ie. my-proxy.com:8080 or 192.168.2.25

To verify the Field Agent can successfully use the newly configured network proxy to reach the Internet, use the Test Connection feature of the Field

Agent Updater page in the Web Console under *Technician Console, Field Agent Updater*. Internet reachability can be tested by using either the default Update URL or any other desired URL and pressing the Test Connection button.

Figure 15: Test Connection Succeeded

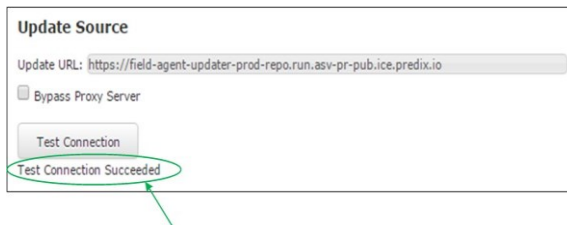

If the URL is reachable, a *Test Connection Succeeded* message is displayed below the *Test Connection* button after the button is pressed. Otherwise, a message will appear indicating that the Test Connection attempt failed.

Configure Time Synchronization

For industrial data time-stamping and Field Agent diagnostic information to operate reliably, it is important for the Field Agent to have an accurate time source. The Field Agent has two methods of synchronizing time – either by using a Network Time Protocol (NTP) server or by pulling time from a web page hosted by an HTTPS web server with its own reliable time source. Either method can be configured in the Web Console under *Technician Console, Time Sync Configuration*.

Figure 16: Technician Console, Time Sync Configuration

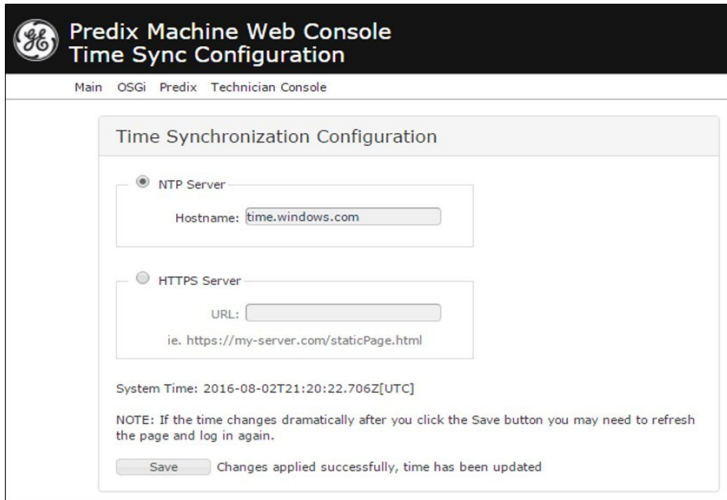

Using NTP Time Synchronization

By default, time synchronization is configured to use the time.windows.com NTP Server. If a valid network path to the Internet exists, time will be synchronized when the Field Agent boots and continuously while running. The current date and time on the Field Agent is displayed above the Save button on the Time Sync Configuration page when the page loads, and can be updated by pressing the Save button or reloading the page.

To change the NTP server to use for time synchronization enter the new NTP server URL in the NTP Server textbox and press the Save button. If the

new server was successfully configured, a success statement will be displayed and the updated time will be displayed. If the time and date was more than 20 minutes out of date prior to time synchronization occurring after pressing the Save button, the Web Console session may end and an error message may be presented indicating that the session's timeout had been reached. Log back into the Web Console to verify the time was updated as expected.

Using HTTPS Time Synchronization

Time synchronization can also be configured to use an HTTPS web server's time by pulling it from the header of the web page it serves. To configure HTTPS time synchronization, select the HTTPS Server radio button on the Time Sync Configuration page, enter a valid HTTPS URL, and press the Save button. If a network proxy is in use, this time synchronization method will only work with HTTPS URLs that do not require a network proxy in order to reach them.

If the new HTTPS URL was successfully configured after pressing the Save button, a success statement will be displayed, and the updated time will be displayed. If the time and date was more than 20 minutes out of date prior to time synchronization occurring after pressing the Save button, the Web Console session may end and an error message may be presented indicating that the session's timeout had been reached. Log back into the Web Console to verify the time was updated as expected.

Redundancy Configuration

With firmware version 9.30 or later, it is possible to configure the CPE400 as a Hot Standby Redundancy CPU with PROFINET IO. The two ports on LAN3 are used exclusively for this purpose: they provide a high-speed data synchronization link between the two CPUs. Connect the upper LAN3 port

of the Primary CPU to the upper LAN3 port of the Secondary CPU and connect the lower LAN3 port of the Primary to the lower LAN3 port of the Secondary. Note that no additional hardware, other than the two redundant CPUs, may be connected to LAN3.

To enable redundancy in a CPE400 project, select the CPE400 target in the *PME Navigator* and use the *Property Inspector* to change the *Enable Redundancy* target property to *True*.

Important: Set the *Background Window Timer* to a minimum of 5ms in both the Primary and Backup CPE400 hardware configurations. The *Background Window Timer* setting may be found on the *Scan* Tab in the CPE400's hardware configuration.

Once configured for HSB Redundancy, the RACT and RBOK LEDs functional. RACT indicates the Local CPU is Ready & Active; RBOK indicates the Remote CPU is Ready. These two LEDs are also reflected in the Status Data of the CPU and are presented as OPC UA Variables.

The OLED display includes two menu items used in conjunction with Redundancy:

- RDN Info provides status information via the OLED display.
- RDN Command permits the operator to perform a Role Switch.

For further details, refer to the *PACSystems Hot Standby CPU Redundancy User Manual*, GFK-2308.

Additional Information

<i>PAC Logic Developer-PLC Getting Started</i>	GFK-1918
<i>PACSystems RX3i and RSTi-EP CPU Reference Manual</i>	GFK-2222
<i>PACSystems RX3i and RSTi-EP TCP/IP Ethernet Communications User's Manual</i>	GFK-2224
<i>PACSystems TCP/IP Ethernet Communications Station Manager Manual</i>	GFK-2225
<i>PACSystems Hot Standby CPU Redundancy User Manual</i>	GFK-2308
<i>PACSystems RX3i System Manual</i>	GFK-2314
<i>PACSystems RXi, RX3i and RSTi-EP Controller Secure Deployment Guide</i>	GFK-2830
<i>PACSystems RX3i and RSTi-EP CPU Programmer's Reference Manual</i>	GFK-2950
<i>PACSystems HART® Pass Through User Manual</i>	GFK-2929
<i>PACSystems RX3i PROFINET IO Controller User Manual</i>	GFK-2571
<i>PROFINET I/O Devices Secure Deployment Guide</i>	GFK-2904
<i>PACSystems RX3i Rackless Energy Pack IC695ACC403 Quick Start Guide</i>	GFK-3000
<i>IC695CPE400 RX3i 64MB Rackless CPU w/Field Agent Important Product Information</i>	GFK-3003
<i>IC695CPE400 RX3i 64MB Rackless CPU w/Field Agent Installation and Maintenance Requirements</i>	GFK-3004
<i>Field Agent User's Guide</i>	GFK-2993
<i>PAC Systems DNP3 Outstation User Manual</i>	GFK-3103

User manuals, product updates and other information sources are available on the Support website <https://www.emerson.com/en-us/support>

General Contact Information

Please visit us for product support or updated product information:

Online Technical Support

<https://www.emerson.com/en-us/support>

Additional Information:

<https://www.emerson.com/industrial-automation-controls>

All Rights Reserved.

We reserve the right to modify or improve the designs or specifications of the products mentioned in this manual at any time without notice. Emerson does not assume responsibility for the selection, use or maintenance of any product. Responsibility for proper selection, use and maintenance of any Emerson product remains solely with the purchaser.

©2021 Emerson Electric Co.

