



# AFM60A-BHIB018x12

AFS/AFM60 Ethernet

**ABSOLUTE ENCODERS**

**SICK**  
Sensor Intelligence.



Illustration may differ



### Ordering information

Type	Part no.
AFM60A-BHIB018x12	1055328

Other models and accessories → [www.sick.com/AFS\\_AFM60\\_Ethernet](http://www.sick.com/AFS_AFM60_Ethernet)

### Detailed technical data

#### Performance

<b>Number of steps per revolution (max. resolution)</b>	262,144 (18 bit)
<b>Number of revolutions</b>	4,096 (12 bit)
<b>Max. resolution (number of steps per revolution x number of revolutions)</b>	18 bit x 12 bit (262,144 x 4,096)
<b>Error limits G</b>	0.03° <sup>1)</sup>
<b>Repeatability standard deviation <math>\sigma_r</math></b>	0.002° <sup>2)</sup>

<sup>1)</sup> In accordance with DIN ISO 1319-1, position of the upper and lower error limit depends on the installation situation, specified value refers to a symmetrical position, i.e. deviation in upper and lower direction is the same.

<sup>2)</sup> In accordance with DIN ISO 55350-13; 68.3% of the measured values are inside the specified area.

#### Interfaces

<b>Communication interface</b>	EtherNet/IP™
<b>Encoder profile</b>	V4.1 class3
<b>Data transmission rate (baud rate)</b>	10 Mbit/s, 100 Mbit/s
<b>Transmission medium</b>	CAT-5e cable
<b>Initialization time</b>	Approx. 10 s
<b>RPI (requested packet interval)</b>	5 ms ... 750 ms
<b>Parameterising data</b>	Number of steps per revolution Number of revolutions PRESET Counting direction Sampling rate for speed calculation Unit for output of speed, acceleration and temperature value Output of scalable limit values such as: position ranges, speed, acceleration, start-up of the CW/CCW directions of rotation, change of direction of rotation, operating hours and hours of shaft movement (motion) Round axis functionality Heartbeat
<b>Available diagnostics data</b>	Minimum and maximum temperature Maximum speed Power-on counter Operating hours counter power-on/motion Counter of direction changes/number of movements cw/number of movements ccw Number of changes of direction Minimum and maximum operating voltage Signal monitoring for singleturn and multiturn

<b>DLR (Device Level Ring)</b>	✓
--------------------------------	---

## Electrical data

<b>Connection type</b>	Male connector, Female connector, 1x, 2x, M12, M12, 4-pin, 4-pin, axial, axial <sup>1) 2)</sup>
<b>Supply voltage</b>	10 ... 30 V
<b>Power consumption</b>	≤ 3 W (without load)
<b>Reverse polarity protection</b>	✓
<b>MTTF: mean time to dangerous failure</b>	80 years (EN ISO 13849-1) <sup>3)</sup>

<sup>1)</sup> A-coded.

<sup>2)</sup> D-coded.

<sup>3)</sup> This product is a standard product and does not constitute a safety component as defined in the Machinery Directive. Calculation based on nominal load of components, average ambient temperature 40 °C, frequency of use 8760 h/a. All electronic failures are considered hazardous. For more information, see document no. 8015532.

## Mechanical data

<b>Mechanical design</b>	Blind hollow shaft
<b>Shaft diameter</b>	15 mm
<b>Weight</b>	0.2 kg
<b>Shaft material</b>	Stainless steel
<b>Flange material</b>	Aluminum
<b>Housing material</b>	Aluminum
<b>Start up torque</b>	0.8 Ncm (+20 °C)
<b>Operating torque</b>	0.6 Ncm (+20 °C)
<b>Permissible movement static</b>	± 0.3 mm (radial) ± 0.5 mm (axial)
<b>Permissible movement dynamic</b>	± 0.05 mm (radial) ± 0.1 mm (axial)
<b>Operating speed</b>	≤ 6,000 min <sup>-1</sup> <sup>1)</sup>
<b>Moment of inertia of the rotor</b>	40 gcm <sup>2</sup>
<b>Bearing lifetime</b>	3 x 10 <sup>9</sup> revolutions
<b>Angular acceleration</b>	≤ 500,000 rad/s <sup>2</sup>

<sup>1)</sup> Allow for self-heating of 3.3 K per 1,000 rpm when designing the operating temperature range.

## Ambient data

<b>EMC</b>	According to EN 61000-6-2 and EN 61000-6-3
<b>Enclosure rating</b>	IP65, shaft side (IEC 60529) IP67, housing side (IEC 60529) <sup>1)</sup>
<b>Permissible relative humidity</b>	90 % (Condensation not permitted)
<b>Operating temperature range</b>	-40 °C ... +85 °C
<b>Storage temperature range</b>	-40 °C ... +100 °C, without package
<b>Resistance to shocks</b>	100 g, 6 ms (EN 60068-2-27)
<b>Resistance to vibration</b>	30 g, 10 Hz ... 2,000 Hz (EN 60068-2-6)

<sup>1)</sup> With mating connector fitted.

## Classifications

<b>ECLASS 5.0</b>	27270502
-------------------	----------

<b>ECLASS 5.1.4</b>	27270502
<b>ECLASS 6.0</b>	27270590
<b>ECLASS 6.2</b>	27270590
<b>ECLASS 7.0</b>	27270502
<b>ECLASS 8.0</b>	27270502
<b>ECLASS 8.1</b>	27270502
<b>ECLASS 9.0</b>	27270502
<b>ECLASS 10.0</b>	27270502
<b>ECLASS 11.0</b>	27270502
<b>ECLASS 12.0</b>	27270502
<b>ETIM 5.0</b>	EC001486
<b>ETIM 6.0</b>	EC001486
<b>ETIM 7.0</b>	EC001486
<b>ETIM 8.0</b>	EC001486
<b>UNSPSC 16.0901</b>	41112113

### Dimensional drawing (Dimensions in mm (inch))

Blind hollow shaft

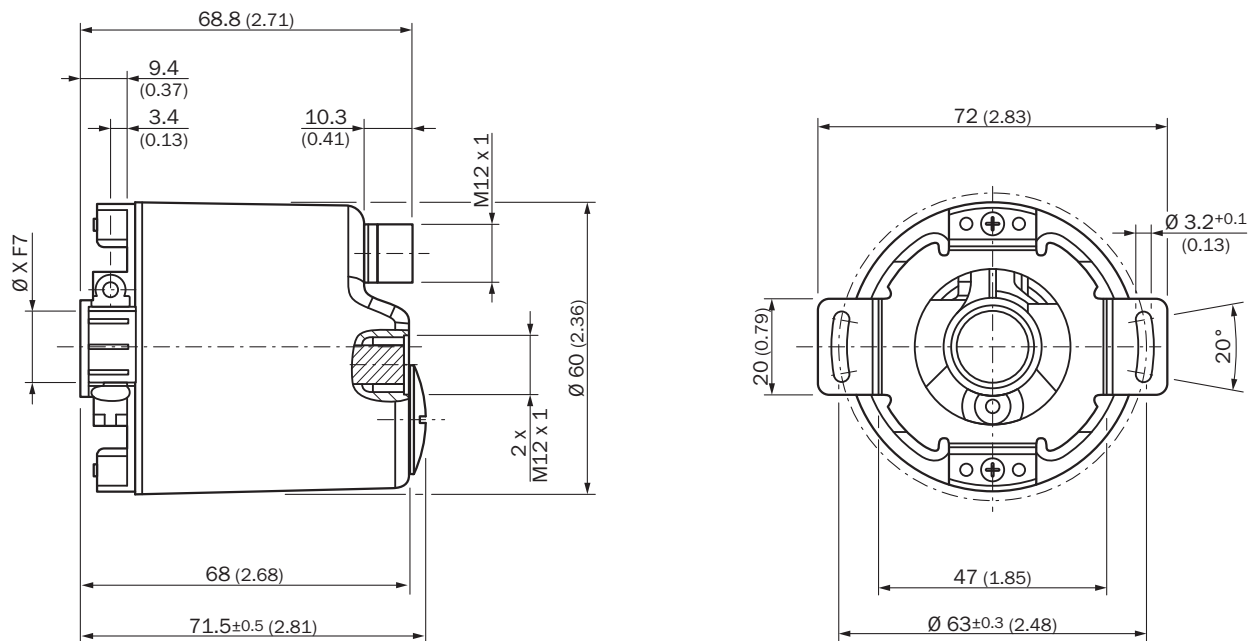

Diameter x f7 corresponds to the shaft diameter

## Attachment specifications

Blind hollow shaft

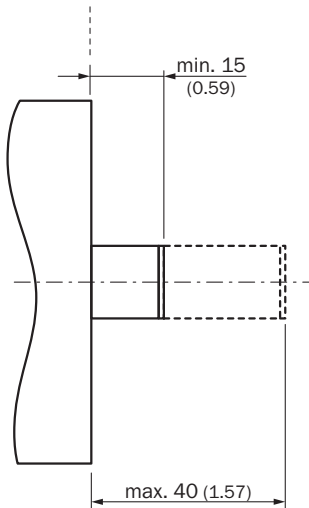

All dimensions in mm (inch)

## PIN assignment

Male connector

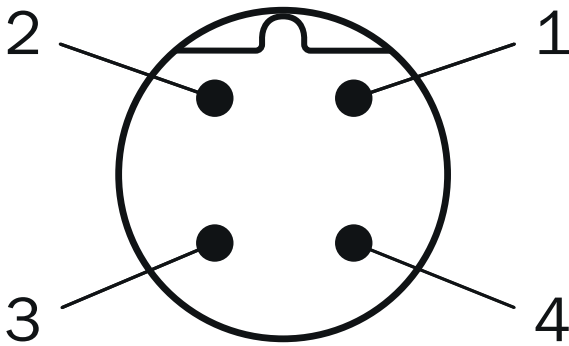

Supply voltage

PIN	Signal
1	10 V ... 30 V
2	Not assigned
3	GND
4	Not assigned

Female connector

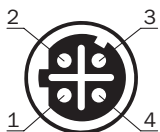

Port 1, Port 2

PIN	Signal
1	T x D+
2	R x D+
3	T x D-
4	R x D-

### Connection diagram

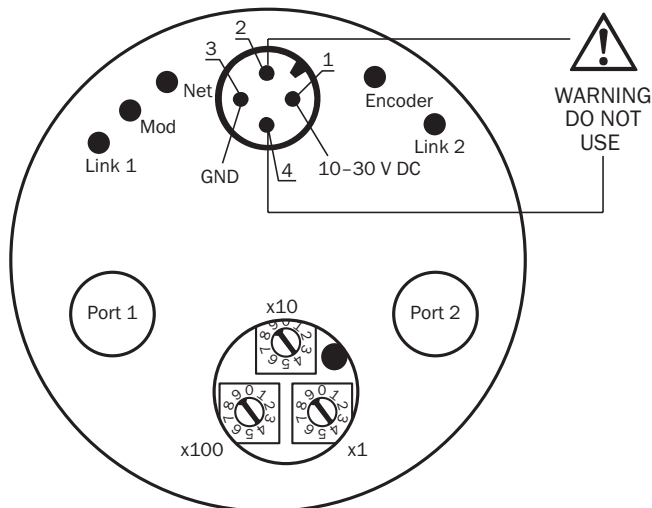









### Recommended accessories

Other models and accessories → [www.sick.com/AFS\\_AFM60\\_Ethernet](http://www.sick.com/AFS_AFM60_Ethernet)







	Brief description	Type	Part no.
<b>Flanges</b>			
	One-sided stator coupling, slot, slot radius 33 mm to 211.9 mm, slot width 5.1 mm	BEF-DS03DFS/VFS	2047431
<b>Others</b>			
	<ul style="list-style-type: none"> <li><b>Connection type head A:</b> Female connector, M12, 4-pin, angled, A-coded</li> <li><b>Description:</b> Unshielded, Head A: female connector, M12, 4-pin, angled, unshielded, for power supply, for cable diameter 3 mm ... 6.5 mm Head B: -</li> <li><b>Connection systems:</b> Screw-type terminals</li> <li><b>Permitted cross-section:</b> ≤ 0.75 mm<sup>2</sup></li> </ul>	DOS-1204-W	6007303
	<ul style="list-style-type: none"> <li><b>Connection type head A:</b> Male connector, M12, 4-pin, straight, D-coded</li> <li><b>Connection type head B:</b> Male connector, M12, 4-pin, straight, D-coded</li> <li><b>Signal type:</b> Ethernet</li> <li><b>Cable:</b> 5 m, 4-wire, CAT5, CAT5e, PUR, halogen-free</li> <li><b>Description:</b> Ethernet, shielded, 5 m cable, M12 male connector straight to M12 male connector straight</li> </ul>	SSL-1204-G05ME90	6045277

	Brief description	Type	Part no.
	<ul style="list-style-type: none"> <li>• <b>Connection type head A:</b> Male connector, M12, 4-pin, straight, D-coded</li> <li>• <b>Connection type head B:</b> Male connector, M12, 4-pin, straight, D-coded</li> <li>• <b>Signal type:</b> Ethernet</li> <li>• <b>Cable:</b> 10 m, 4-wire, CAT5, CAT5e, PUR, halogen-free</li> <li>• <b>Description:</b> Ethernet, shielded, 10 m cable, M12 male connector straight to M12 male connector straight</li> </ul>	SSL-1204-G10ME90	6045279
	<ul style="list-style-type: none"> <li>• <b>Connection type head A:</b> Male connector, M12, 4-pin, straight, D-coded</li> <li>• <b>Connection type head B:</b> Flying leads</li> <li>• <b>Signal type:</b> Ethernet</li> <li>• <b>Cable:</b> 2 m, 4-wire, CAT5, CAT5e, PUR, halogen-free</li> <li>• <b>Description:</b> Ethernet, shielded, M12 male connector D-coded straight to open end</li> </ul>	STL-1204-G02ME90	6045284
	<ul style="list-style-type: none"> <li>• <b>Connection type head A:</b> Male connector, M12, 4-pin, straight, D-coded</li> <li>• <b>Connection type head B:</b> Flying leads</li> <li>• <b>Signal type:</b> Ethernet</li> <li>• <b>Cable:</b> 5 m, 4-wire, CAT5, CAT5e, PUR, halogen-free</li> <li>• <b>Description:</b> Ethernet, shielded, M12 male connector D-coded straight to open end</li> </ul>	STL-1204-G05ME90	6045285
	<ul style="list-style-type: none"> <li>• <b>Connection type head A:</b> Male connector, M12, 4-pin, straight, D-coded</li> <li>• <b>Connection type head B:</b> Flying leads</li> <li>• <b>Signal type:</b> Ethernet</li> <li>• <b>Cable:</b> 10 m, 4-wire, CAT5, CAT5e, PUR, halogen-free</li> <li>• <b>Description:</b> Ethernet, shielded, M12 male connector D-coded straight to open end</li> </ul>	STL-1204-G10ME90	6045286
	<ul style="list-style-type: none"> <li>• <b>Connection type head A:</b> Male connector, M12, 4-pin, angled, D-coded</li> <li>• <b>Connection type head B:</b> Flying leads</li> <li>• <b>Signal type:</b> Ethernet</li> <li>• <b>Cable:</b> 2 m, 4-wire, CAT5, CAT5e, PUR, halogen-free</li> <li>• <b>Description:</b> Ethernet, shielded, M12 male connector D-coded angled to open end</li> </ul>	STL-1204-W02ME90	6047912
	<ul style="list-style-type: none"> <li>• <b>Connection type head A:</b> Female connector, M12, 4-pin, straight, D-coded</li> <li>• <b>Signal type:</b> Ethernet</li> <li>• <b>Cable:</b> CAT5, CAT5e</li> <li>• <b>Description:</b> Ethernet, shielded, Head A: female connector, M12, 4-pin, straight, D-coded, shielded, for cable diameter 4 mm ... 8 mm Head B: -</li> <li>• <b>Connection systems:</b> IDC quick connection</li> <li>• <b>Permitted cross-section:</b> 0.14 mm<sup>2</sup> ... 0.34 mm<sup>2</sup></li> </ul>	DOS-1204-GE	6048153
	<ul style="list-style-type: none"> <li>• <b>Connection type head A:</b> Female connector, M12, 4-pin, angled, D-coded</li> <li>• <b>Signal type:</b> Ethernet</li> <li>• <b>Cable:</b> CAT5, CAT5e</li> <li>• <b>Description:</b> Ethernet, shielded, Head A: female connector, M12, 4-pin, angled, D-coded, shielded, for cable diameter 4 mm ... 8 mm Head B: -</li> <li>• <b>Connection systems:</b> IDC quick connection</li> <li>• <b>Permitted cross-section:</b> 0.14 mm<sup>2</sup> ... 0.34 mm<sup>2</sup></li> </ul>	DOS-1204-WE	6048154
	<ul style="list-style-type: none"> <li>• <b>Connection type head A:</b> Male connector, M12, 4-pin, angled, D-coded</li> <li>• <b>Connection type head B:</b> Flying leads</li> <li>• <b>Signal type:</b> Ethernet</li> <li>• <b>Cable:</b> 10 m, 4-wire, CAT5, CAT5e, PUR, halogen-free</li> <li>• <b>Description:</b> Ethernet, shielded, M12 male connector D-coded angled to open end</li> </ul>	STL-1204-W10ME90	6047914
	<ul style="list-style-type: none"> <li>• <b>Connection type head A:</b> Male connector, M12, 4-pin, angled, D-coded</li> <li>• <b>Connection type head B:</b> Flying leads</li> <li>• <b>Signal type:</b> Ethernet</li> <li>• <b>Cable:</b> 25 m, 4-wire, CAT5, CAT5e, PUR, halogen-free</li> <li>• <b>Description:</b> Ethernet, shielded, M12 male connector D-coded angled to open end</li> </ul>	STL-1204-W25ME90	6047915
	<ul style="list-style-type: none"> <li>• <b>Connection type head A:</b> Male connector, M12, 4-pin, straight, D-coded</li> <li>• <b>Signal type:</b> Ethernet</li> <li>• <b>Cable:</b> CAT5, CAT5e</li> <li>• <b>Description:</b> Ethernet, shielded, Head A: male connector, M12, 4-pin, straight, D-coded, shielded, for cable diameter 4 mm ... 8 mm Head B: -</li> <li>• <b>Connection systems:</b> IDC quick connection</li> <li>• <b>Permitted cross-section:</b> 0.14 mm<sup>2</sup> ... 0.34 mm<sup>2</sup></li> </ul>	STE-1204-GE01	6048151

	Brief description	Type	Part no.
	<ul style="list-style-type: none"> <li>• <b>Connection type head A:</b> Male connector, M12, 4-pin, angled, D-coded</li> <li>• <b>Signal type:</b> Ethernet</li> <li>• <b>Cable:</b> CAT5, CAT5e</li> <li>• <b>Description:</b> Ethernet, shielded, Head A: male connector, M12, 4-pin, angled, D-coded, shielded, for cable diameter 4 mm ... 8 mm Head B: -</li> <li>• <b>Connection systems:</b> IDC quick connection</li> <li>• <b>Permitted cross-section:</b> 0.14 mm<sup>2</sup> ... 0.34 mm<sup>2</sup></li> </ul>	STE-1204-WE	6048152
	<ul style="list-style-type: none"> <li>• <b>Connection type head A:</b> Male connector, RJ45, 8-pin, straight</li> <li>• <b>Signal type:</b> Gigabit Ethernet</li> <li>• <b>Cable:</b> CAT6A</li> <li>• <b>Description:</b> Gigabit Ethernet, shielded, Head A: male connector, RJ45, 8-pin, straight, shielded, EtherNet/IP, for cable diameter 4.5 mm ... 8 mm Head B: -</li> <li>• <b>Connection systems:</b> IDC quick connection</li> <li>• <b>Permitted cross-section:</b> 4.5 mm<sup>2</sup> ... 8 mm<sup>2</sup></li> </ul>	STE-0J08-GE	6048150
	<ul style="list-style-type: none"> <li>• <b>Connection type head A:</b> Female connector, M12, 4-pin, D-coded</li> <li>• <b>Connection type head B:</b> Female connector, RJ45, 8-pin</li> <li>• <b>Signal type:</b> Ethernet</li> <li>• <b>Cable:</b> CAT5, CAT5e</li> <li>• <b>Description:</b> Ethernet, shielded</li> <li>• <b>Note:</b> Cabinet through</li> </ul>	Feedthrough female connector Ethernet RJ45	6048180
	<ul style="list-style-type: none"> <li>• <b>Connection type head A:</b> Female connector, M12, 4-pin, straight, A-coded</li> <li>• <b>Connection type head B:</b> Flying leads</li> <li>• <b>Signal type:</b> Sensor/actuator cable</li> <li>• <b>Cable:</b> 2 m, 4-wire, PUR, halogen-free</li> <li>• <b>Description:</b> Sensor/actuator cable, unshielded</li> <li>• <b>Application:</b> Zones with oils and lubricants, Drag chain operation, Robot</li> </ul>	YF2A14-020UB3XLEAX	2095607
	<ul style="list-style-type: none"> <li>• <b>Connection type head A:</b> Female connector, M12, 4-pin, straight, A-coded</li> <li>• <b>Connection type head B:</b> Flying leads</li> <li>• <b>Signal type:</b> Sensor/actuator cable</li> <li>• <b>Cable:</b> 5 m, 4-wire, PUR, halogen-free</li> <li>• <b>Description:</b> Sensor/actuator cable, unshielded</li> <li>• <b>Application:</b> Zones with oils and lubricants, Drag chain operation, Robot</li> </ul>	YF2A14-050UB3XLEAX	2095608
	<ul style="list-style-type: none"> <li>• <b>Connection type head A:</b> Female connector, M12, 4-pin, straight, A-coded</li> <li>• <b>Connection type head B:</b> Flying leads</li> <li>• <b>Signal type:</b> Sensor/actuator cable</li> <li>• <b>Cable:</b> 10 m, 4-wire, PUR, halogen-free</li> <li>• <b>Description:</b> Sensor/actuator cable, unshielded</li> <li>• <b>Application:</b> Zones with oils and lubricants, Drag chain operation, Robot</li> </ul>	YF2A14-100UB3XLEAX	2095609
	<ul style="list-style-type: none"> <li>• <b>Connection type head A:</b> Female connector, M12, 4-pin, straight, A-coded</li> <li>• <b>Connection type head B:</b> Flying leads</li> <li>• <b>Signal type:</b> Sensor/actuator cable</li> <li>• <b>Cable:</b> 25 m, 4-wire, PUR, halogen-free</li> <li>• <b>Description:</b> Sensor/actuator cable, unshielded</li> <li>• <b>Application:</b> Zones with oils and lubricants, Drag chain operation, Robot</li> </ul>	YF2A14-250UB3XLEAX	2095615
	<ul style="list-style-type: none"> <li>• <b>Connection type head A:</b> Female connector, M12, 4-pin, angled, A-coded</li> <li>• <b>Connection type head B:</b> Flying leads</li> <li>• <b>Signal type:</b> Sensor/actuator cable</li> <li>• <b>Cable:</b> 2 m, 4-wire, PUR, halogen-free</li> <li>• <b>Description:</b> Sensor/actuator cable, unshielded</li> <li>• <b>Application:</b> Zones with oils and lubricants, Drag chain operation, Robot</li> </ul>	YG2A14-020UB3XLEAX	2095766
	<ul style="list-style-type: none"> <li>• <b>Connection type head A:</b> Female connector, M12, 4-pin, angled, A-coded</li> <li>• <b>Connection type head B:</b> Flying leads</li> <li>• <b>Signal type:</b> Sensor/actuator cable</li> <li>• <b>Cable:</b> 5 m, 4-wire, PUR, halogen-free</li> <li>• <b>Description:</b> Sensor/actuator cable, unshielded</li> <li>• <b>Application:</b> Zones with oils and lubricants, Drag chain operation, Robot</li> </ul>	YG2A14-050UB3XLEAX	2095767



	Brief description	Type	Part no.
	<ul style="list-style-type: none"> <li>• <b>Connection type head A:</b> Female connector, M12, 4-pin, angled, A-coded</li> <li>• <b>Connection type head B:</b> Flying leads</li> <li>• <b>Signal type:</b> Sensor/actuator cable</li> <li>• <b>Cable:</b> 10 m, 4-wire, PUR, halogen-free</li> <li>• <b>Description:</b> Sensor/actuator cable, unshielded</li> <li>• <b>Application:</b> Zones with oils and lubricants, Drag chain operation, Robot</li> </ul>	YG2A14-100UB3XLEAX	2095768
	<ul style="list-style-type: none"> <li>• <b>Connection type head A:</b> Female connector, M12, 4-pin, angled, A-coded</li> <li>• <b>Connection type head B:</b> Flying leads</li> <li>• <b>Signal type:</b> Sensor/actuator cable</li> <li>• <b>Cable:</b> 25 m, 4-wire, PUR, halogen-free</li> <li>• <b>Description:</b> Sensor/actuator cable, unshielded</li> <li>• <b>Application:</b> Zones with oils and lubricants, Drag chain operation, Robot</li> </ul>	YG2A14-250UB3XLEAX	2095771
	<ul style="list-style-type: none"> <li>• <b>Connection type head A:</b> Male connector, M12, 4-pin, angled, D-coded</li> <li>• <b>Connection type head B:</b> Male connector, M12, 4-pin, angled, D-coded</li> <li>• <b>Signal type:</b> Ethernet, PROFINET</li> <li>• <b>Cable:</b> 2 m, 4-wire, PUR, halogen-free</li> <li>• <b>Description:</b> Ethernet, PROFINET, shielded</li> <li>• <b>Application:</b> Drag chain operation, Zones with oils and lubricants</li> </ul>	YN2D24-020PN1N2D24	2106168
	<ul style="list-style-type: none"> <li>• <b>Connection type head A:</b> Male connector, M12, 4-pin, straight, D-coded</li> <li>• <b>Connection type head B:</b> Male connector, M12, 4-pin, angled, D-coded</li> <li>• <b>Signal type:</b> Ethernet, PROFINET</li> <li>• <b>Cable:</b> 2 m, 4-wire, PUR, halogen-free</li> <li>• <b>Description:</b> Ethernet, PROFINET, shielded</li> <li>• <b>Application:</b> Drag chain operation, Zones with oils and lubricants</li> </ul>	YM2D24-020PN1N2D24	2106165
	<ul style="list-style-type: none"> <li>• <b>Connection type head A:</b> Male connector, M12, 4-pin, straight, D-coded</li> <li>• <b>Connection type head B:</b> Male connector, M12, 4-pin, angled, D-coded</li> <li>• <b>Signal type:</b> Ethernet, PROFINET</li> <li>• <b>Cable:</b> 5 m, 4-wire, PUR, halogen-free</li> <li>• <b>Description:</b> Ethernet, PROFINET, shielded</li> <li>• <b>Application:</b> Drag chain operation, Zones with oils and lubricants</li> </ul>	YM2D24-050PN1N2D24	2106166
	<ul style="list-style-type: none"> <li>• <b>Connection type head A:</b> Male connector, M12, 4-pin, straight, D-coded</li> <li>• <b>Connection type head B:</b> Male connector, M12, 4-pin, angled, D-coded</li> <li>• <b>Signal type:</b> Ethernet, PROFINET</li> <li>• <b>Cable:</b> 10 m, 4-wire, PUR, halogen-free</li> <li>• <b>Description:</b> Ethernet, PROFINET, shielded</li> <li>• <b>Application:</b> Drag chain operation, Zones with oils and lubricants</li> </ul>	YM2D24-100PN1N2D24	2106167
	<ul style="list-style-type: none"> <li>• <b>Connection type head A:</b> Male connector, M12, 4-pin, straight, D-coded</li> <li>• <b>Connection type head B:</b> Male connector, M12, 4-pin, straight, D-coded</li> <li>• <b>Signal type:</b> Ethernet, PROFINET</li> <li>• <b>Cable:</b> 2 m, 4-wire, PUR, halogen-free</li> <li>• <b>Description:</b> Ethernet, PROFINET, shielded</li> <li>• <b>Application:</b> Drag chain operation, Zones with oils and lubricants</li> </ul>	YM2D24-020PN1M2D24	2106159
	<ul style="list-style-type: none"> <li>• <b>Connection type head A:</b> Male connector, M12, 4-pin, angled, D-coded</li> <li>• <b>Connection type head B:</b> Male connector, RJ45, 4-pin, straight</li> <li>• <b>Signal type:</b> Ethernet, PROFINET</li> <li>• <b>Cable:</b> 2 m, 4-wire, PUR, halogen-free</li> <li>• <b>Description:</b> Ethernet, PROFINET, shielded</li> <li>• <b>Application:</b> Drag chain operation, Zones with oils and lubricants</li> </ul>	YN2D24-020PN1MRJA4	2106162
	<ul style="list-style-type: none"> <li>• <b>Connection type head A:</b> Male connector, M12, 4-pin, straight, D-coded</li> <li>• <b>Connection type head B:</b> Male connector, RJ45, 4-pin, straight</li> <li>• <b>Signal type:</b> Ethernet, PROFINET</li> <li>• <b>Cable:</b> 10 m, 4-wire, PUR, halogen-free</li> <li>• <b>Description:</b> Ethernet, PROFINET, shielded</li> <li>• <b>Application:</b> Drag chain operation, Zones with oils and lubricants</li> </ul>	YM2D24-100PN1MRJA4	2106185
	<ul style="list-style-type: none"> <li>• <b>Connection type head A:</b> Male connector, M12, 4-pin, straight, D-coded</li> <li>• <b>Connection type head B:</b> Male connector, RJ45, 4-pin, straight</li> <li>• <b>Signal type:</b> Ethernet, PROFINET</li> <li>• <b>Cable:</b> 5 m, 4-wire, PUR, halogen-free</li> <li>• <b>Description:</b> Ethernet, PROFINET, shielded</li> <li>• <b>Application:</b> Drag chain operation, Zones with oils and lubricants</li> </ul>	YM2D24-050PN1MRJA4	2106184

	Brief description	Type	Part no.
	<ul style="list-style-type: none"> <li>• <b>Connection type head A:</b> Male connector, M12, 4-pin, straight, D-coded</li> <li>• <b>Connection type head B:</b> Male connector, RJ45, 8-pin, straight</li> <li>• <b>Signal type:</b> Ethernet</li> <li>• <b>Cable:</b> 5 m, 4-wire, AWG26, PUR, halogen-free</li> <li>• <b>Description:</b> Ethernet, twisted pair, shielded</li> </ul>	YM2D24-050EA1MRJA4	6034415
	<ul style="list-style-type: none"> <li>• <b>Connection type head A:</b> Male connector, M12, 4-pin, straight, D-coded</li> <li>• <b>Connection type head B:</b> Male connector, RJ45, 4-pin, straight</li> <li>• <b>Signal type:</b> Ethernet, PROFINET</li> <li>• <b>Cable:</b> 2 m, 4-wire, PUR, halogen-free</li> <li>• <b>Description:</b> Ethernet, PROFINET, shielded</li> <li>• <b>Application:</b> Drag chain operation, Zones with oils and lubricants</li> </ul>	YM2D24-020PN1MRJA4	2106182
	<ul style="list-style-type: none"> <li>• <b>Connection type head A:</b> Male connector, M12, 4-pin, angled, D-coded</li> <li>• <b>Connection type head B:</b> Male connector, RJ45, 4-pin, straight</li> <li>• <b>Signal type:</b> Ethernet, PROFINET</li> <li>• <b>Cable:</b> 10 m, 4-wire, PUR, halogen-free</li> <li>• <b>Description:</b> Ethernet, PROFINET, shielded</li> <li>• <b>Application:</b> Drag chain operation, Zones with oils and lubricants</li> </ul>	YN2D24-100PN1MRJA4	2106164
	<ul style="list-style-type: none"> <li>• <b>Connection type head A:</b> Male connector, M12, 4-pin, angled, D-coded</li> <li>• <b>Connection type head B:</b> Male connector, RJ45, 4-pin, straight</li> <li>• <b>Signal type:</b> Ethernet, PROFINET</li> <li>• <b>Cable:</b> 5 m, 4-wire, PUR, halogen-free</li> <li>• <b>Description:</b> Ethernet, PROFINET, shielded</li> <li>• <b>Application:</b> Drag chain operation, Zones with oils and lubricants</li> </ul>	YN2D24-050PN1MRJA4	2106163
	<ul style="list-style-type: none"> <li>• <b>Connection type head A:</b> Male connector, M12, 4-pin, angled, D-coded</li> <li>• <b>Connection type head B:</b> Flying leads</li> <li>• <b>Signal type:</b> Ethernet, PROFINET</li> <li>• <b>Cable:</b> 5 m, 4-wire, PUR, halogen-free</li> <li>• <b>Description:</b> Ethernet, PROFINET, shielded</li> <li>• <b>Application:</b> Drag chain operation, Zones with oils and lubricants</li> </ul>	YN2D24-050PN1XLEAX	2106175
	<ul style="list-style-type: none"> <li>• <b>Connection type head A:</b> Male connector, M12, 4-pin, angled, D-coded</li> <li>• <b>Connection type head B:</b> Male connector, RJ45, 4-pin, straight</li> <li>• <b>Signal type:</b> Ethernet, PROFINET</li> <li>• <b>Cable:</b> 3 m, 4-wire, PUR, halogen-free</li> <li>• <b>Description:</b> Ethernet, PROFINET, shielded</li> <li>• <b>Application:</b> Drag chain operation, Zones with oils and lubricants</li> </ul>	YN2D24-030PN1MRJA4	2144265

## SICK AT A GLANCE

SICK is one of the leading manufacturers of intelligent sensors and sensor solutions for industrial applications. A unique range of products and services creates the perfect basis for controlling processes securely and efficiently, protecting individuals from accidents and preventing damage to the environment.

We have extensive experience in a wide range of industries and understand their processes and requirements. With intelligent sensors, we can deliver exactly what our customers need. In application centers in Europe, Asia and North America, system solutions are tested and optimized in accordance with customer specifications. All this makes us a reliable supplier and development partner.

Comprehensive services complete our offering: SICK LifeTime Services provide support throughout the machine life cycle and ensure safety and productivity.

For us, that is “Sensor Intelligence.”

## WORLDWIDE PRESENCE:

Contacts and other locations –[www.sick.com](http://www.sick.com)