

# AHM36I-BBCL014x12

AHS/AHM36

**ABSOLUTE ENCODERS**

**SICK**  
Sensor Intelligence.



Illustration may differ



### Ordering information

| Type              | Part no. |
|-------------------|----------|
| AHM36I-BBCL014x12 | 1099339  |

Other models and accessories → [www.sick.com/AHS\\_AHM36](http://www.sick.com/AHS_AHM36)

### Detailed technical data

#### Performance

|   |                                  |
|---|----------------------------------|
| <b>Number of steps per revolution (max. resolution)</b>                         | 16,384 (14 bit)                  |
| <b>Number of revolutions</b>  | 4,096 (12 bit)                   |
| <b>Max. resolution (number of steps per revolution x number of revolutions)</b> | 14 bit x 12 bit (16,384 x 4,096) |
| <b>Error limits G</b>   | 0.35° (at 20 °C) <sup>1)</sup>   |
| <b>Repeatability standard deviation <math>\sigma_r</math></b>                   | 0.2° (at 20 °C) <sup>2)</sup>    |

<sup>1)</sup> In accordance with DIN ISO 1319-1, position of the upper and lower error limit depends on the installation situation, specified value refers to a symmetrical position, i.e. deviation in upper and lower direction is the same.

<sup>2)</sup> In accordance with DIN ISO 55350-13; 68.3% of the measured values are inside the specified area.

#### Interfaces

|   |  |
|---|--|
| <b>Communication interface</b>            | CANopen  |
| <b>Data protocol</b>                      | CANopen CiA DS-301 V4.02, CiA DSP-305 LSS, Encoder Profile: - CiA DS-406, V3.2. - Class C2   |
| <b>Address setting</b>                    | 0 ... 127, default: 5  |
| <b>Data transmission rate (baud rate)</b> | 20 kbit/s ... 1,000 kbit/s, default: 125 kbit/s  |
| <b>Initialization time</b>                | 2 s <sup>1)</sup>  |
| <b>Process data</b>                       | Position, speed, Temperature   |
| <b>Parameterising data</b>                | Number of steps per revolution<br>Number of revolutions<br>PRESET<br>Counting direction<br>Sampling rate for speed calculation<br>Unit for output of the speed value<br>Round axis functionality<br>Electronic cams(2 channels x 8 cams) |
| <b>Available diagnostics data</b>         | Minimum and maximum temperature<br>Maximum speed<br>Power-on counter<br>Operating hours counter power-on/motion  |

<sup>1)</sup> Valid positional data can be read once this time has elapsed.

<sup>2)</sup> See accessories.

|                           |  |
|---------------------------|--|
|                           | Counter of direction changes/number of movements cw/number of movements ccw<br>Minimum and maximum operating voltage |
| <b>Status information</b> | CANopen status via status LED  |
| <b>Bus termination</b>    | Via external terminator <sup>2)</sup>  |

<sup>1)</sup> Valid positional data can be read once this time has elapsed.

<sup>2)</sup> See accessories.

## Electrical data

|  |  |
|--|--|
| <b>Connection type</b>                       | Cable, 5-wire, universal, 3 m            |
| <b>Supply voltage</b>                        | 10 ... 30 V                              |
| <b>Power consumption</b>                     | ≤ 1.5 W (without load)                   |
| <b>Reverse polarity protection</b>           | ✓  |
| <b>MTTFd: mean time to dangerous failure</b> | 270 years (EN ISO 13849-1) <sup>1)</sup> |

<sup>1)</sup> This product is a standard product and does not constitute a safety component as defined in the Machinery Directive. Calculation based on nominal load of components, average ambient temperature 40 °C, frequency of use 8760 h/a. All electronic failures are considered hazardous. For more information, see document no. 8015532.

## Mechanical data

|                                       |   |
|---------------------------------------|---|
| <b>Mechanical design</b>              | Blind hollow shaft                      |
| <b>Shaft diameter</b>                 | 8 mm                                    |
| <b>Weight</b>                         | 0.2 kg <sup>1)</sup>                    |
| <b>Shaft material</b>                 | Stainless steel 1,4305                  |
| <b>Flange material</b>                | Stainless steel 1,4305                  |
| <b>Material, stator coupling</b>      | Stainless steel 1,4305                  |
| <b>Housing material</b>               | Stainless steel 1,4305                  |
| <b>Material, cable</b>                | PUR                                     |
| <b>Start up torque</b>                | 1 Ncm (+20 °C)                          |
| <b>Operating torque</b>               | < 1 Ncm (+20 °C)                        |
| <b>Permissible movement static</b>    | ± 0.3 mm, ± 0.3 mm (radial, axial)      |
| <b>Permissible movement dynamic</b>   | ± 0.1 mm (radial)<br>± 0.1 mm (axial)   |
| <b>Operating speed</b>                | ≤ 6,000 min <sup>-1</sup> <sup>2)</sup> |
| <b>Moment of inertia of the rotor</b> | 23 gcm <sup>2</sup>                     |
| <b>Bearing lifetime</b>               | 2.0 x 10 <sup>9</sup> revolutions       |
| <b>Angular acceleration</b>           | ≤ 500,000 rad/s <sup>2</sup>            |

<sup>1)</sup> Based on devices with male connector.

<sup>2)</sup> Allow for self-heating of 3.5 K per 1,000 rpm when designing the operating temperature range.

## Ambient data

|                                      |  |
|--------------------------------------|--|
| <b>EMC</b>                           | According to EN 61000-6-2 and EN 61000-6-3 |
| <b>Enclosure rating</b>              | IP67 (IEC 60529)<br>IP69K (IEC 60529)      |
| <b>Permissible relative humidity</b> | 90 % (Condensation not permitted)          |
| <b>Operating temperature range</b>   | -40 °C ... +85 °C                          |

<sup>1)</sup> For side-mounted encoders (horizontal encoder shaft, vertical stator coupling), additional damping measures may be required in some cases as resonances can arise. Furthermore, the cable must be fastened with the shortest possible distance to the encoder.

|                                  |   |
|----------------------------------|---|
| <b>Storage temperature range</b> | -40 °C ... +100 °C, without package                   |
| <b>Resistance to shocks</b>      | 100 g, 6 ms (EN 60068-2-27)                           |
| <b>Resistance to vibration</b>   | 20 g, 10 Hz ... 2,000 Hz (EN 60068-2-6) <sup>1)</sup> |

<sup>1)</sup> For side-mounted encoders (horizontal encoder shaft, vertical stator coupling), additional damping measures may be required in some cases as resonances can arise. Furthermore, the cable must be fastened with the shortest possible distance to the encoder.

### Classifications

|                       |          |
|-----------------------|----------|
| <b>ECLASS 5.0</b>     | 27270502 |
| <b>ECLASS 5.1.4</b>   | 27270502 |
| <b>ECLASS 6.0</b>     | 27270590 |
| <b>ECLASS 6.2</b>     | 27270590 |
| <b>ECLASS 7.0</b>     | 27270502 |
| <b>ECLASS 8.0</b>     | 27270502 |
| <b>ECLASS 8.1</b>     | 27270502 |
| <b>ECLASS 9.0</b>     | 27270502 |
| <b>ECLASS 10.0</b>    | 27270502 |
| <b>ECLASS 11.0</b>    | 27270502 |
| <b>ECLASS 12.0</b>    | 27270502 |
| <b>ETIM 5.0</b>       | EC001486 |
| <b>ETIM 6.0</b>       | EC001486 |
| <b>ETIM 7.0</b>       | EC001486 |
| <b>ETIM 8.0</b>       | EC001486 |
| <b>UNSPSC 16.0901</b> | 41112113 |

### Dimensional drawing (Dimensions in mm (inch))

Blind hollow shaft, cable

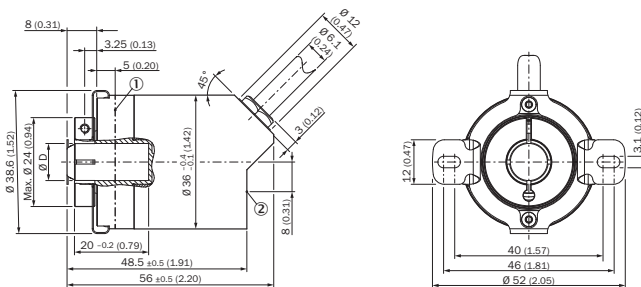

Non-tolerated dimensions according to DIN-ISO 2768-mk

- ① Measuring point for operating temperature
- ② Measuring point for vibrations

| Type             | Shaft diameter<br>Ø D F7 |
|------------------|--------------------------|
| AHx36x-BAxxxxxxx | 6 mm                     |
| AHx36x-BBxxxxxxx | 8 mm                     |
| AHx36x-BCxxxxxxx | 1/4"                     |
| AHx36x-BDxxxxxxx | 10 mm                    |

| Type             | Shaft diameter<br>Ø D F7 |
|------------------|--------------------------|
| AHx36x-BKxxxxxxx | 3/8"                     |

### Attachment specifications

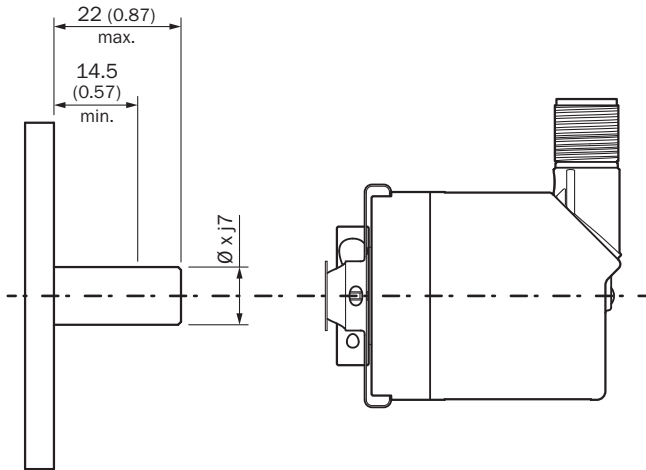



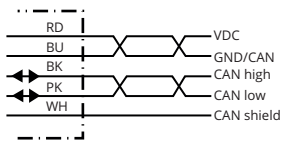

### PIN assignment



| PIN     | Signal      | Wire colors (cable connection) | Function   |
|---------|-------------|--------------------------------|--|
| 1       | CAN Shield  | White                          | Screen   |
| 2       | VDC         | Red                            | Supply voltage<br>Encoder<br>10 V DC ... 30 V DC |
| 3       | GND/CAN GND | Blue                           | 0 V (GND)  |
| 4       | CAN high    | Black                          | CAN signal                                       |
| 5       | CAN low     | Pink                           | CAN signal                                       |
| Housing | -           | -                              | Screen   |

### Recommended accessories

Other models and accessories → [www.sick.com/AHS\\_AHM36](http://www.sick.com/AHS_AHM36)

|   | Brief description  | Type               | Part no. |
|---|--|--------------------|----------|
| Flanges   |  |                    |          |
|  | Standard stator coupling, AHS/AHM36  | BEF-DS16-AHX       | 2108615  |
| Others  |  |                    |          |
|  | <ul style="list-style-type: none"> <li>• <b>Connection type head A:</b> Female connector, M12, 5-pin, straight, A-coded</li> <li>• <b>Description:</b> Shielded</li> <li>• <b>Connection systems:</b> Screw-type terminals</li> <li>• <b>Permitted cross-section:</b> ≤ 0.75 mm<sup>2</sup></li> <li>• <b>Application:</b> Hygienic and washdown zones</li> </ul>  | YF12ES5-0075S5586A | 2097335  |
|  | <ul style="list-style-type: none"> <li>• <b>Connection type head A:</b> Male connector, M12, 5-pin, straight, A-coded</li> <li>• <b>Description:</b> Shielded</li> <li>• <b>Connection systems:</b> Screw-type terminals</li> <li>• <b>Permitted cross-section:</b> ≤ 0.75 mm<sup>2</sup></li> <li>• <b>Application:</b> Hygienic and washdown zones</li> </ul>  | YM12ES5-0075S5586A | 2097336  |
|  | <ul style="list-style-type: none"> <li>• <b>Connection type head A:</b> Female connector, terminal box, 8-pin, straight</li> <li>• <b>Connection type head B:</b> Female connector, D-Sub, 9-pin, straight</li> <li>• <b>Signal type:</b> CANopen</li> <li>• <b>Cable:</b> 0.4 m</li> <li>• <b>Description:</b> CANopen, shielded, Adapter cable for encoders with CANopen interface and cable outlet</li> </ul> | DDL-0D04-G0M5BC9   | 2083355  |

## SICK AT A GLANCE

SICK is one of the leading manufacturers of intelligent sensors and sensor solutions for industrial applications. A unique range of products and services creates the perfect basis for controlling processes securely and efficiently, protecting individuals from accidents and preventing damage to the environment.

We have extensive experience in a wide range of industries and understand their processes and requirements. With intelligent sensors, we can deliver exactly what our customers need. In application centers in Europe, Asia and North America, system solutions are tested and optimized in accordance with customer specifications. All this makes us a reliable supplier and development partner.

Comprehensive services complete our offering: SICK LifeTime Services provide support throughout the machine life cycle and ensure safety and productivity.

For us, that is “Sensor Intelligence.”

## WORLDWIDE PRESENCE:

Contacts and other locations –[www.sick.com](http://www.sick.com)