



AHS36A-SCCK016384

AHS/AHM36

ABSOLUTE ENCODERS

SICK
Sensor Intelligence.



Ordering information

Type	Part no.
AHS36A-SCCK016384	1079915

Other models and accessories → www.sick.com/AHS_AHM36

Illustration may differ



Detailed technical data

Performance

Number of steps per revolution (max. resolution)	16,384 (14 bit)
Error limits G	0.35° (at 20 °C) ¹⁾
Repeatability standard deviation σ_r	0.2° (at 20 °C) ²⁾

¹⁾ In accordance with DIN ISO 1319-1, position of the upper and lower error limit depends on the installation situation, specified value refers to a symmetrical position, i.e. deviation in upper and lower direction is the same.

²⁾ In accordance with DIN ISO 55350-13; 68.3% of the measured values are inside the specified area.

Interfaces

Communication interface	CANopen
Data protocol	CANopen CiA DS-301 V4.02, CiA DSP-305 LSS, Encoder Profile: - CiA DS-406, V3.2. - Class C2
Address setting	0 ... 127, default: 5
Data transmission rate (baud rate)	20 kbit/s ... 1,000 kbit/s, default: 125 kbit/s
Initialization time	2 s ¹⁾
Process data	Position, speed, Temperature
Parameterising data	Number of steps per revolution PRESET Counting direction Sampling rate for speed calculation Unit for output of the speed value Electronic cams(2 channels x 8 cams)
Available diagnostics data	Minimum and maximum temperature Maximum speed Power-on counter Operating hours counter power-on/motion Counter of direction changes/number of movements cw/number of movements ccw Minimum and maximum operating voltage
Status information	CANopen status via status LED
Bus termination	Via external terminator ²⁾

¹⁾ Valid positional data can be read once this time has elapsed.

²⁾ See accessories.

Electrical data

Connection type	Cable, 5-wire, universal, 1.5 m
Supply voltage	10 ... 30 V
Power consumption	≤ 1.5 W (without load)
Reverse polarity protection	✓
MTTFd: mean time to dangerous failure	270 years (EN ISO 13849-1) ¹⁾

¹⁾ This product is a standard product and does not constitute a safety component as defined in the Machinery Directive. Calculation based on nominal load of components, average ambient temperature 40 °C, frequency of use 8760 h/a. All electronic failures are considered hazardous. For more information, see document no. 8015532.

Mechanical data

Mechanical design	Solid shaft, face mount flange
Shaft diameter	10 mm ¹⁾
Shaft length	24 mm
Weight	0.12 kg ²⁾
Shaft material	Stainless steel
Flange material	Aluminum
Housing material	Zinc
Material, cable	PUR
Start up torque	1 Ncm (+20 °C)
Operating torque	< 1 Ncm (+20 °C)
Permissible shaft loading	40 N (radial) 20 N (axial)
Operating speed	≤ 6,000 min ⁻¹ ³⁾
Moment of inertia of the rotor	2.5 gcm ²
Bearing lifetime	3.6 x 10 ⁸ revolutions
Angular acceleration	≤ 500,000 rad/s ²

¹⁾ For use with the adapters 2072298 and 2072295.

²⁾ Based on devices with male connector.

³⁾ Allow for self-heating of 3.5 K per 1,000 rpm when designing the operating temperature range.

Ambient data

EMC	According to EN 61000-6-2 and EN 61000-6-3
Enclosure rating	IP66 (IEC 60529) IP67 (IEC 60529)
Permissible relative humidity	90 % (Condensation not permitted)
Operating temperature range	-40 °C ... +85 °C
Storage temperature range	-40 °C ... +100 °C, without package
Resistance to shocks	100 g, 6 ms (EN 60068-2-27)
Resistance to vibration	20 g, 10 Hz ... 2,000 Hz (EN 60068-2-6)

Classifications

ECLASS 5.0	27270502
ECLASS 5.1.4	27270502
ECLASS 6.0	27270590

ECLASS 6.2	27270590
ECLASS 7.0	27270502
ECLASS 8.0	27270502
ECLASS 8.1	27270502
ECLASS 9.0	27270502
ECLASS 10.0	27270502
ECLASS 11.0	27270502
ECLASS 12.0	27270502
ETIM 5.0	EC001486
ETIM 6.0	EC001486
ETIM 7.0	EC001486
ETIM 8.0	EC001486
UNSPSC 16.0901	41112113

Dimensional drawing (Dimensions in mm (inch))

Solid shaft, face mount flange, cable

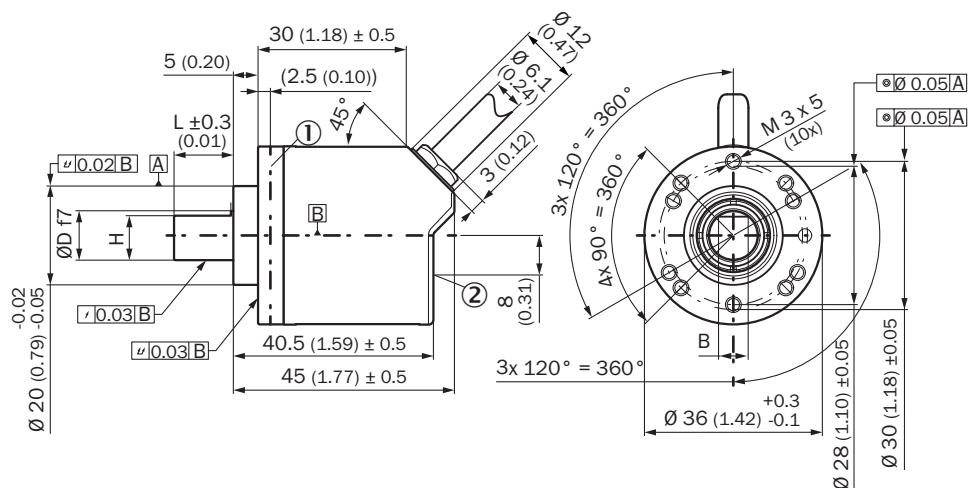

- ① Measuring point for operating temperature
- ② Measuring point for vibrations

Type	Shaft diameter Ø D f7	B	H
AHx36x-S1xxxxxxxx AHx36x-S3xxxxxxxx	6 mm	3,6 mm	5,4 mm
AHx36x-S9xxxxxxxx AHx36x-S5xxxxxxxx	8 mm	3,9 mm	7,5 mm
AHx36x-S2xxxxxxxx AHx36x-S4xxxxxxxx AHx36x-SCxxxxxxxx	10 mm	6 mm	9 mm
AHx36x-SAxxxxxxxx AHx36x-S8xxxxxxxx	1/4"	3,85 mm	5,7 mm
AHx36x-SBxxxxxxxx AHx36x-S7xxxxxxxx	3/8"	4,35 mm	9 mm

Attachment specifications

Solid shaft, face mount flange with flange adapter, centering collar D20 on D36 (BEF-FA-020-036, 2072298)

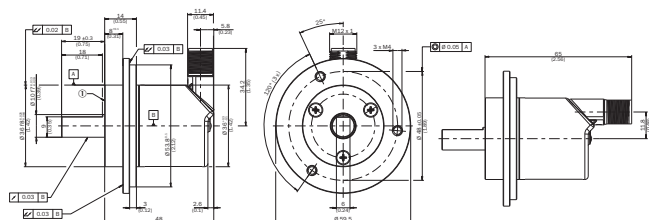

Order example for 10 mm shaft diameter: AHx36x-SCxx0xxxxx + BEF-FA-020-036 (adapter is not pre-assembled)

① Measuring point for operating temperature

Solid shaft, face mount flange with flange adapter, centering collar D20 on D30 (BEF-FA-020-030, 2072295)

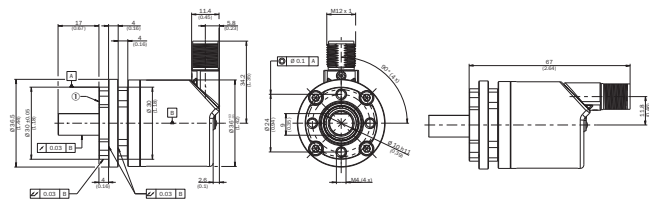

Order example for 10 mm shaft diameter: AHx36x-SCxx0xxxxx + BEF-FA-020-030 (adapter is not pre-assembled)

① Measuring point for operating temperature



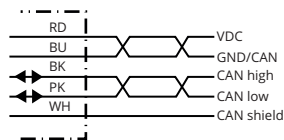







PIN assignment





PIN	Signal	Wire colors (cable connection)	Function
1	CAN Shield	White	Screen
2	VDC	Red	Supply voltage Encoder 10 V DC ... 30 V DC
3	GND/CAN GND	Blue	0 V (GND)
4	CAN high	Black	CAN signal
5	CAN low	Pink	CAN signal
Housing	-	-	Screen

Recommended accessories

Other models and accessories → www.sick.com/AHS_AHM36

	Brief description	Type	Part no.
Programming and configuration tools			
	Hand-held programming device for the programmable SICK AHS/AHM36 CANopen encoders, TMS/TMM61 CANopen inclination sensors, TMS/TMM88 CANopen, TMS/TMM88 Analog, and wire draw encoders with AHS/AHM36 CANopen. Compact dimensions, low weight, and intuitive operation.	PGT-12-Pro	1076313
Shaft adaptation			
	Double loop coupling, shaft diameter 8 mm / 10 mm, max. shaft offset: radially +/- 0,25 mm, axially +/-0,4 mm, angle +/- 4 degrees;max. speed 10.000 rpm, -30 to +120 degrees Celsius, torsional spring stiffness of 150 Nm/rad	KUP-0810-D	5326704
	Claw coupling, shaft diameter 8 mm / 10 mm, damping element 80 shore blue, maximum shaft offset: radial ± 0.22 mm, axial ± 1 mm angular ± 1.3°, max. speed 19,000 rpm, angle of twist max. 10°, -30 °C to +80 °C, max. torque 800 Ncm, tightening torque of screws: ISO 4029 150 Ncm, material: aluminum flange, damping element: polyurethane	KUP-0810-J	2128267
	Bellows coupling, shaft diameter 10 mm/10 mm; maximum shaft offset: radial +/- 0.25 mm, axial +/- 0.4 mm, angular +/- 4°; max. revolutions 10,000 rpm, -30° to +120 °C, max. torque 120 Ncm; material: stainless steel bellows, aluminum clamping hubs	KUP-1010-B	5312983
	Double loop coupling, shaft diameter 10 mm / 10 mm, Maximum shaft offset: radial +/- 2.5 mm, axial +/- 3 mm, angular +/- 10°; max. speed 3,000 rpm, -30° to +80 °C, max. torque 1.5 Nm; material: polyurethane, galvanized steel flange	KUP-1010-D	5326703
	Spring washer coupling, shaft diameter 10 mm / 10 mm, maximum shaft offset, radial ± 0.3 mm, axial ± 0.4 mm, angle ± 2.5°, torsion spring stiffness 30 Nm/rad; material: aluminum flange, glass-fiber reinforced polyamide membrane and hardened steel coupling pin	KUP-1010-F	5312986
	Claw coupling, shaft diameter 10 mm / 10 mm, damping element 80 shore blue, maximum shaft offset: radial ± 0.22 mm, axial ± 1 mm angular ± 1.3°, max. speed 19,000 rpm, angle of twist max. 10°, -30 °C to +80 °C, max. torque 800 Ncm, tightening torque of screws: ISO 4029 150 Ncm, material: aluminum flange, damping element: polyurethane	KUP-1010-J	2127054
	10 mm / 12 mm; maximum shaft offset: radial +/- 0.25 mm, axial +/- 0.4 mm, angular +/- 4°; max. revolutions 10,000 rpm, -30° to +120 °C, max. torque 120 Ncm; material: stainless steel bellows, aluminum clamping hubs	KUP-1012-B	5312984
	Double loop coupling, shaft diameter 10 mm / 12 mm, Maximum shaft offset: radial +/- 2.5 mm, axial +/- 3 mm, angular +/- 10°; max. speed 3,000 rpm, -30° to +80 °C, max. torque 1.5 Nm; material: polyurethane, galvanized steel flange	KUP-1012-D	5326702
	Claw coupling, shaft diameter 10 mm / 12 mm, damping element 80 shore blue, maximum shaft offset: radial ± 0.22 mm, axial ± 1 mm angular ± 1.3°, max. speed 19,000 rpm, angle of twist max. 10°, -30 °C to +80 °C, max. torque 800 Ncm, tightening torque of screws: ISO 4029 150 Ncm, material: aluminum flange, damping element: polyurethane	KUP-1012-J	2128265
Others			
	<ul style="list-style-type: none"> • Connection type head A: Flying leads • Connection type head B: Flying leads • Signal type: CANopen, DeviceNet™ • Cable: 4-wire, twisted pair • Description: CANopen, DeviceNet™, shielded • Note: Wire shield Al-Pt film, overall shield C-screen tin-plated 	LTG-2804-MW	6028328

	Brief description	Type	Part no.
	<ul style="list-style-type: none"> • Connection type head A: Female connector, M12, 5-pin, straight, X-coded • Signal type: CANopen, DeviceNet™ • Description: CANopen, DeviceNet™, shielded, Head A: female connector, M12, 5-pin, straight, shielded, for cable diameter 4.5 mm ... 7 mm Head B: - • Connection systems: Screw-type terminals • Permitted cross-section: ≤ 0.75 mm² 	DOS-1205-GA	6027534
	<ul style="list-style-type: none"> • Connection type head A: Male connector, M12, 5-pin, straight, A-coded • Signal type: CANopen, DeviceNet™ • Description: CANopen, DeviceNet™, shielded, Head A: male connector, M12, 5-pin, straight, A coded, shielded, for cable diameter 4 mm ... 8 mm Head B: - • Connection systems: Screw-type terminals • Permitted cross-section: ≤ 0.75 mm² 	STE-1205-GA	6027533
	<ul style="list-style-type: none"> • Connection type head A: Male connector, M12, 5-pin, straight • Signal type: CANopen • Description: CANopen, unshielded, CAN male connector, with terminating resistor 	CAN male connector	6021167
	<ul style="list-style-type: none"> • Connection type head A: Female connector, M12, 5-pin, A-coded • Connection type head B: Male connector, M12, 5-pin, A-coded • Connection type head C: Female connector, M12, 5-pin, A-coded • Description: T-piece for simultaneous connection to sender and receiver, splits the cable from the control cabinet to the sender and receiver • Note: 5-pin 	DSC-1205T000025KM0	6030664
	<ul style="list-style-type: none"> • Connection type head A: Female connector, M12, 5-pin, straight, A-coded • Connection type head B: Female connector, M12, 5-pin, straight, A-coded • Signal type: CAN, Power • Cable: 0.5 m, 5-wire • Description: CAN, Power, Y-CAN cable 	Y-CAN cable	6027647
	<ul style="list-style-type: none"> • Connection type head A: Female connector, M12, 5-pin, straight, A-coded • Connection type head B: Flying leads • Signal type: Fieldbus, CANopen, DeviceNet™ • Cable: 2 m, 4-wire, PUR, halogen-free • Description: Fieldbus, CANopen, DeviceNet™, shielded • Application: Drag chain operation, Zones with oils and lubricants 	YF2A15-020C1BXLEAX	2106283
	<ul style="list-style-type: none"> • Connection type head A: Female connector, M12, 5-pin, straight, A-coded • Connection type head B: Flying leads • Signal type: Fieldbus, CANopen, DeviceNet™ • Cable: 5 m, 4-wire, PUR, halogen-free • Description: Fieldbus, CANopen, DeviceNet™, shielded • Application: Drag chain operation, Zones with oils and lubricants 	YF2A15-050C1BXLEAX	2106284
	<ul style="list-style-type: none"> • Connection type head A: Female connector, M12, 5-pin, straight, A-coded • Connection type head B: Flying leads • Signal type: Fieldbus, CANopen, DeviceNet™ • Cable: 10 m, 4-wire, PUR, halogen-free • Description: Fieldbus, CANopen, DeviceNet™, shielded • Application: Drag chain operation, Zones with oils and lubricants 	YF2A15-100C1BXLEAX	2106286
	<ul style="list-style-type: none"> • Connection type head A: Female connector, M12, 5-pin, straight, A-coded • Connection type head B: Male connector, M12, 5-pin, straight, A-coded • Signal type: Fieldbus, CANopen, DeviceNet™ • Cable: 2 m, 4-wire, PUR, halogen-free • Description: Fieldbus, CANopen, DeviceNet™, shielded • Application: Drag chain operation, Zones with oils and lubricants 	YF2A15-020C1BM2A15	2106279
	<ul style="list-style-type: none"> • Connection type head A: Female connector, M12, 5-pin, straight, A-coded • Connection type head B: Male connector, M12, 5-pin, straight, A-coded • Signal type: Fieldbus, CANopen, DeviceNet™ • Cable: 5 m, 4-wire, PUR, halogen-free • Description: Fieldbus, CANopen, DeviceNet™, shielded • Application: Drag chain operation, Zones with oils and lubricants 	YF2A15-050C1BM2A15	2106281

	Brief description	Type	Part no.
	<ul style="list-style-type: none"> • Connection type head A: Female connector, M12, 5-pin, straight, A-coded • Connection type head B: Male connector, M12, 5-pin, straight, A-coded • Signal type: Fieldbus, CANopen, DeviceNet™ • Cable: 10 m, 4-wire, PUR, halogen-free • Description: Fieldbus, CANopen, DeviceNet™, shielded • Application: Drag chain operation, Zones with oils and lubricants 	YF2A15-100C1BM2A15	2106282
	<ul style="list-style-type: none"> • Connection type head A: Female connector, terminal box, 8-pin, straight • Connection type head B: Female connector, D-Sub, 9-pin, straight • Signal type: CANopen • Cable: 0.4 m • Description: CANopen, shielded, Adapter cable for encoders with CANopen interface and cable outlet 	DDL-0D04-G0M5BC9	2083355

SICK AT A GLANCE

SICK is one of the leading manufacturers of intelligent sensors and sensor solutions for industrial applications. A unique range of products and services creates the perfect basis for controlling processes securely and efficiently, protecting individuals from accidents and preventing damage to the environment.

We have extensive experience in a wide range of industries and understand their processes and requirements. With intelligent sensors, we can deliver exactly what our customers need. In application centers in Europe, Asia and North America, system solutions are tested and optimized in accordance with customer specifications. All this makes us a reliable supplier and development partner.

Comprehensive services complete our offering: SICK LifeTime Services provide support throughout the machine life cycle and ensure safety and productivity.

For us, that is “Sensor Intelligence.”

WORLDWIDE PRESENCE:

Contacts and other locations –www.sick.com