



AHS36I-S3PM016384

AHS/AHM36

ABSOLUTE ENCODERS

SICK
Sensor Intelligence.



Illustration may differ



Ordering information

Type	Part no.
AHS36I-S3PM016384	1107741

Other models and accessories → www.sick.com/AHS_AHM36

Detailed technical data

Performance

Number of steps per revolution (max. resolution)	16,384 (14 bit)
Error limits G	0.35° (at 20 °C) ¹⁾
Repeatability standard deviation σ_r	0.2° (at 20 °C) ²⁾

¹⁾ In accordance with DIN ISO 1319-1, position of the upper and lower error limit depends on the installation situation, specified value refers to a symmetrical position, i.e. deviation in upper and lower direction is the same.

²⁾ In accordance with DIN ISO 55350-13; 68.3% of the measured values are inside the specified area.

Interfaces

Communication interface	SSI
Initialization time	100 ms ¹⁾
Position forming time	125 µs
Process data	Position
Parameterising data	Number of steps per revolution PRESET Counting direction Code type Offset of position bits Position error bit SSI mode
Code type	Gray, binary
Code sequence parameter adjustable	CW/CCW (V/R) configurable via programming tool or cable
Clock frequency	2 MHz ²⁾
Set (electronic adjustment)	H-active (L = 0 - 3 V, H = 4,0 - U _s V)
CW/CCW (counting sequence when turning)	L-active (L = 0 - 1 V, H = 2,0 - U _s V)

¹⁾ Valid positional data can be read once this time has elapsed.

²⁾ Minimum, LOW level (Clock +): 250 ns.

Electrical data

Connection type	Cable, 8-wire, universal, 5 m
Supply voltage	4.5 ... 32 V DC
Power consumption	≤ 1.5 W (without load)
Reverse polarity protection	✓
MTTFd: mean time to dangerous failure	230 years (EN ISO 13849-1) ¹⁾

¹⁾ This product is a standard product and does not constitute a safety component as defined in the Machinery Directive. Calculation based on nominal load of components, average ambient temperature 40 °C, frequency of use 8760 h/a. All electronic failures are considered hazardous. For more information, see document no. 8015532.

Mechanical data

Mechanical design	Solid shaft, face mount flange
Shaft diameter	6 mm
Shaft length	12 mm
Weight	0.2 kg ¹⁾
Shaft material	Stainless steel 1,4305
Flange material	Stainless steel 1,4305
Housing material	Stainless steel 1,4305
Material, cable	PUR
Start up torque	1 Ncm (+20 °C)
Operating torque	< 1 Ncm (+20 °C)
Permissible shaft loading	40 N (radial) 20 N (axial)
Operating speed	≤ 6,000 min ⁻¹ ²⁾
Moment of inertia of the rotor	2.5 gcm ²
Bearing lifetime	3.6 x 10 ⁸ revolutions
Angular acceleration	≤ 500,000 rad/s ²

¹⁾ Based on devices with male connector.

²⁾ Allow for self-heating of 3.5 K per 1,000 rpm when designing the operating temperature range.

Ambient data

EMC	According to EN 61000-6-2 and EN 61000-6-3
Enclosure rating	IP67 (IEC 60529) IP69K (IEC 60529)
Permissible relative humidity	90 % (Condensation not permitted)
Operating temperature range	-40 °C ... +100 °C
Storage temperature range	-40 °C ... +100 °C, without package
Resistance to shocks	100 g, 6 ms (EN 60068-2-27)
Resistance to vibration	20 g, 10 Hz ... 2,000 Hz (EN 60068-2-6) ¹⁾

¹⁾ For side-mounted encoders (horizontal encoder shaft, vertical stator coupling), additional damping measures may be required in some cases as resonances can arise. Furthermore, the cable must be fastened with the shortest possible distance to the encoder.

Classifications

ECLASS 5.0	27270502
ECLASS 5.1.4	27270502

ECLASS 6.0	27270590
ECLASS 6.2	27270590
ECLASS 7.0	27270502
ECLASS 8.0	27270502
ECLASS 8.1	27270502
ECLASS 9.0	27270502
ECLASS 10.0	27270502
ECLASS 11.0	27270502
ECLASS 12.0	27270502
ETIM 5.0	EC001486
ETIM 6.0	EC001486
ETIM 7.0	EC001486
ETIM 8.0	EC001486
UNSPSC 16.0901	41112113

Dimensional drawing (Dimensions in mm (inch))

Solid shaft, face mount flange, cable

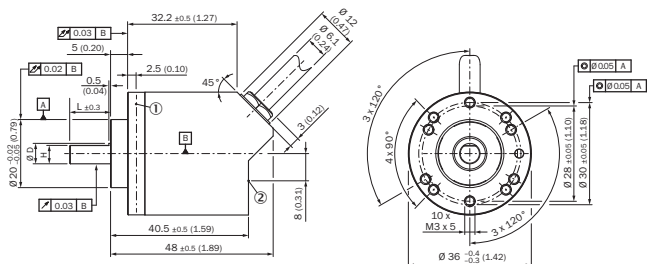

Non-tolerated dimensions according to DIN-ISO 2768-mk

- ① Measuring point for operating temperature
- ② Measuring point for vibrations

Type	Shaft diameter Ø D f7	B	H
AHx36x-S1xxxxxxxx AHx36x-S3xxxxxxxx	6 mm	3,6 mm	5,4 mm
AHx36x-S9xxxxxxxx AHx36x-S5xxxxxxxx	8 mm	3,9 mm	7,5 mm
AHx36x-S2xxxxxxxx AHx36x-S4xxxxxxxx AHx36x-SCxxxxxxxx	10 mm	6 mm	9 mm
AHx36x-SAxxxxxxxx AHx36x-S8xxxxxxxx	1/4"	3,85 mm	5,7 mm
AHx36x-SBxxxxxxxx AHx36x-S7xxxxxxxx	3/8"	4,35 mm	9 mm

Attachment specifications

Solid shaft, face mount flange with flange adapter, centering collar D20 on D24 (BEF-FA-020-024-I, 2103982)

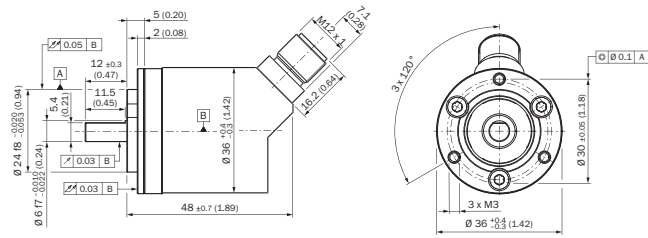

Order example for 6 mm shaft diameter: AHx36I-S3xx0xxxxx + BEF-FA-020-024-I (adapter is not pre-assembled)
 Solid shaft, face mount flange with flange adapter, centering collar D20 on D36, 2 mm high (BEF-FA-020-036-2-I, 2103984)

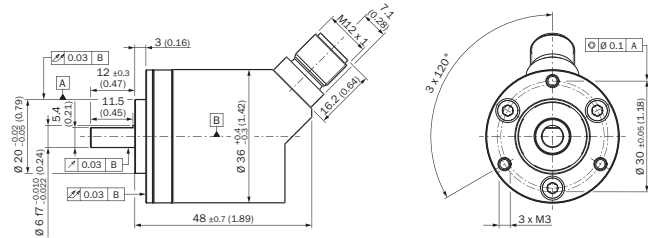

Order example for 6 mm shaft diameter: AHx36I-S3xx0xxxxx + BEF-FA-020-036-2-I (adapter is not pre-assembled)
 Solid shaft, face mount flange with flange adapter, centering collar D20 on D50 (BEF-FA-020-050-I, 2103985)

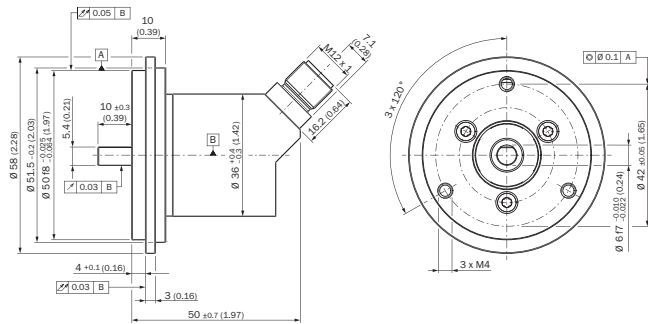

Order example for 6 mm shaft diameter: AHx36I-S3xx0xxxxx + BEF-FA-020-050-I (adapter is not pre-assembled)

PIN assignment

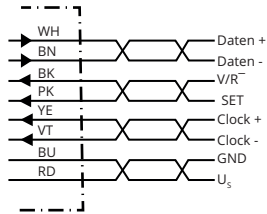









PIN	Wire colors (cable connection)	Signal	Explanation
1	Brown	Data -	Interface signals
2	White	Data +	Interface signals
3	Black	V/R	Sequence in direction of rotation
4	Pink	SET	Electronic adjustment Interface signals

PIN	Wire colors (cable connection)	Signal	Explanation
5	Yellow	Clock +	Interface signals
6	Purple	Clock -	Interface signals
7	Blue	GND	Ground connection
8	Red	U _S	Operating voltage
		Screen	Screen connected to housing on encoder side. Connected to ground on control side.

Recommended accessories

Other models and accessories → www.sick.com/AHS_AHM36

	Brief description	Type	Part no.
Programming and configuration tools			
	USB programming unit, for programmable SICK encoders AFS60, AFM60, DFS60, VFS60, DFV60 and wire draw encoders with programmable encoders	PGT-08-S	1036616
	Programming unit display for programmable SICK DFS60, DFV60, AFS/AFM60, AHS/AHM36 encoders, and wire draw encoder with DFS60, AFS/AFM60 and AHS/AHM36. Compact dimensions, low weight, and intuitive operation.	PGT-10-Pro	1072254
Shaft adaptation			
	Bellows coupling, shaft diameter 6 mm / 6 mm, maximum shaft offset: radial ± 0.25 mm, axial ± 0.4 mm, angular +/- 4°; max. speed 10,000 rpm, -30 °C to +120 °C, max. torque 120 Ncm; material: stainless steel bellows, aluminum hub	KUP-0606-B	5312981
	Bellows coupling, shaft diameter 6 mm / 10 mm, maximum shaft offset: radial ± 0.25 mm, axial ± 0.4 mm, angular +/- 4°; max. speed 10,000 rpm, -30 °C to +120 °C, max. torque 120 Ncm; material: stainless steel bellows, aluminum hub	KUP-0610-B	5312982
	Double loop coupling, shaft diameter 6 mm / 10 mm, max. shaft offset: radially +/- 2,5 mm, axially +/-3 mm, angle +/- 10 degrees;max. speed 3.000 rpm, -30 to +80 degrees Celsius, torsional spring stiffness of 25 Nm/rad	KUP-0610-D	5326697
	Spring washer coupling, shaft diameter 6 mm / 10 mm, Maximum shaft offset: radial +/- 0.3 mm, axial +/- 0.4 mm, angular +/- 2.5°; max. speed 12,000 rpm, -10° to +80 °C, max. torque 60 Ncm; material: aluminum flange, glass fiber-reinforced polyamide membrane and hardened steel coupling pin	KUP-0610-F	5312985
	Claw coupling, shaft diameter 6 mm / 10 mm, damping element 80 shore blue, maximum shaft offset: radial ± 0.22 mm, axial ± 1 mm angular ± 1.3°, max. speed 19,000 rpm, angle of twist max. 10°, -30 °C to +80 °C, max. torque 800 Ncm, tightening torque of screws: ISO 4029 150 Ncm, material: aluminum flange, damping element: polyurethane	KUP-0610-J	2127056
Others			
	<ul style="list-style-type: none"> Connection type head A: Female connector, M12, 8-pin, straight, A-coded Description: Shielded Connection systems: Screw-type terminals Permitted cross-section: 0.25 mm² ... 0.5 mm² Application: Hygienic and washdown zones 	YF12ES8-0050S5586A	2097334
	<ul style="list-style-type: none"> Connection type head A: Male connector, M12, 8-pin, straight, A-coded Description: Shielded Connection systems: Screw-type terminals Permitted cross-section: ≤ 0.5 mm² Application: Hygienic and washdown zones 	YM12ES8-0050S5586A	2097337

	Brief description	Type	Part no.
	<ul style="list-style-type: none">• Connection type head A: Female connector, terminal box, 8-pin, straight• Connection type head B: Male connector, D-Sub, 9-pin, straight• Signal type: SSI + incremental• Cable: 0.5 m, 4-wire, PVC• Description: SSI + incremental, shielded, Programming cable for PGT-08-S and PGT-10-S programming tool• Note: Programming adapter cable for programming tool PGT-10-Pro and PGT-08-S	DSL-0D08-G0M5AC3	2061739

SICK AT A GLANCE

SICK is one of the leading manufacturers of intelligent sensors and sensor solutions for industrial applications. A unique range of products and services creates the perfect basis for controlling processes securely and efficiently, protecting individuals from accidents and preventing damage to the environment.

We have extensive experience in a wide range of industries and understand their processes and requirements. With intelligent sensors, we can deliver exactly what our customers need. In application centers in Europe, Asia and North America, system solutions are tested and optimized in accordance with customer specifications. All this makes us a reliable supplier and development partner.

Comprehensive services complete our offering: SICK LifeTime Services provide support throughout the machine life cycle and ensure safety and productivity.

For us, that is “Sensor Intelligence.”

WORLDWIDE PRESENCE:

Contacts and other locations –www.sick.com